

IDEAONE 2023

fami

.04



INNOVATION
SINCE 1929.



DISSET
ODISEO



ASESORAMIENTO

¿Hay algún proyecto en particular que te gustaría hacer realidad?
¿Una nueva área que equipar? Los asesores comerciales de Fami te ayudarán a analizar todas tus necesidades y crear el mobiliario ideal para tu empresa.



GARANTÍA

La garantía de 10 años de los productos Fami refleja el uso de materiales de calidad y el cuidado y la dedicación en la fabricación para que nuestros muebles sean fiables y duren en el tiempo.



PEDIDOS

Pedir los productos Fami Ideaone nunca fue tan fácil! Elige entre los diferentes equipos y ponte en contacto con tu agente o distribuidor local para completar tu pedido.



GAMA DE COLORES

Los muebles Fami Ideaone se presentan en colores estándar, tanto unicolor como bicolor, que varían en función del producto elegido. Bajo pedido hay colores adicionales disponibles para personalizar cada zona de trabajo o adaptar el mobiliario a los colores corporativos.



VALIDEZ

El catálogo Fami Ideaone tiene una validez del 27/04/2023 al 31/03/2024. Los precios se consideran válidos durante este periodo, salvo posibles variaciones, errores tipográficos u omisiones de impresión.



FILIALES Y DISTRIBUIDORES

¡Fami está siempre a tu lado! Con los años hemos creado cuatro filiales europeas y una amplia red de vendedores y distribuidores, tanto en Italia como en el extranjero, que nos permiten ofrecerte asesoramiento y asistencia allí donde estés.



ASISTENCIA

Nuestro servicio posventa está siempre a tu disposición para cualquier duda, información o problema. En caso de productos dañados o rotos, siempre recibirás repuestos originales Fami en sustitución.

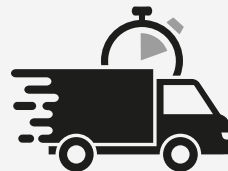

ENVIO

El mobiliario industrial Fami Ideaone está disponible con entrega en 20 días laborables.



CUBAS COLECTORAS + REPISAS Y BANDEJAS PERFORM DE ACERO

Adecuadas para líquidos inflamables de las categorías GHS 1 - 3 y líquidos contaminantes del agua de las categorías GHS 1 - 4.

Sustancias corrosivas no permitidas.



CUBAS COLECTORAS DE PE

Adecuadas para líquidos contaminantes del agua de las categorías GHS 1 - 4.

Sustancias inflamables no permitidas.

Los precios no incluyen gastos de transporte.

new

MASTER



PIKPAD



THE BLOCK



BIN CART



ECOLOGÍA



índice

BANCOS DE TRABAJO

2

- **WORK MASTER BR** 2
preconfigurados 3
componentes 12
material de separación 20
preconfigurados 22
- **WORK-WORK UP** 24
preconfigurados 25
componentes 34
material de separación 40
preconfigurados 42
- **DYNAMIC** 44
preconfigurados 45
componentes 48



TABIQUES EQUIPADOS

52

- **WORK LOOK** 52
preconfigurados 53
componentes 58
persianas 64
unidades de pared 65
- **COMPONENTS** 66
mesa 67
sillas 68
- **ERGO WORK** 70
preconfigurados 71
componentes 78
preconfigurados 82
- **TOOL ORGANIZER** 84
Unipok 85
The Block 86
Pikpad 88
- **IRON TEAM** 90
Iron Team 91
Iron Team Electric 96
Iron Team Light 98



ARMARIOS DE CAJONES

100

SERIE START

- **FLEXA** 100
36x27 EH 717x600 mm 102
material de separación 103
54x27 EH 1023x600 mm 104
material de separación 105



SERIE PRO

- **MASTER DE** 106
36x36 EH 714x726 mm 110
material de separación 111
54x36 EH 1020x726 mm 112
material de separación 113
54x36 EH 1020x726 mm 114
accesorios 115



SERIE PRO+

- **MASTER** 116
18x27 EH 408x573 mm 122
27x27 EH 561x573 mm 124
36x27 EH 714x573 mm 128
54x27 EH 1020x573 mm 136
27x36 EH 561x726 mm 140
36x36 EH 714x726 mm 148
45x36 EH 867x726 mm 160
54x36 EH 1020x726 mm 162
64x36 EH 1190x726 mm 168
78x36 EH 1428x726 mm 170
accesorios 172



- material de separación:
- 18x27 EH 408x573 mm 176
 - 27x27 EH 561x573 mm 178
 - 36x27 EH 714x573 mm 180
 - 54x27 EH 1020x573 mm 182
 - 27x36 EH 561x726 mm 184
 - 36x36 EH 714x726 mm 186
 - 45x36 EH 867x726 mm 188
 - 54x36 EH 1020x726 mm 190
 - 64x36 EH 1190x726 mm 192
 - 78x36 EH 1428x726 mm 193



ARMARIOS PARA ORDENADOR

194

- MASTER CS 196
- STANDARD CS 198



ARMARIOS CON PUERTAS

200

- PERFORM
PUERTAS BATIENTES 200
 - 64x27 EH 1193x555x1000 mm 201
 - 64x27 EH 1193x555x2000 mm 202
 - 24x27 EH 512x555x1000 mm 203
 - 54x27 EH 1023x555x1000 mm 204
 - 54x27 EH 1023x555x2000 mm 206
 - componentes 214
 - material de separación 226
- PERFORM
PUERTAS CORREDERAS 228
 - 54x27 EH 1020x600x2000 mm 230
 - 54x27 EH 1020x600x946 mm 231
 - 78x27 EH 1428x600x2000 mm 232
 - 54+54x27 EH 2040x600x2000 mm 234
 - 54+54x27 EH 2040x600x946 mm 236
 - componentes 237
 - material de separación 245
- PERFORM
ARMARIOS PARA
VESTUARIO 246



NC

252

- NC 253
- componentes 254



ECOLOGÍA

256

- PORTA BIG BAG 257
- CUCHARAS ABATIBLES 258
- CUBAS DE RECOGIDA 260
- ARMARIOS DE SEGURIDAD 267



CARROS

270

- CLEVER 270
 - Clever Small preconfigurados 271
 - Clever Large preconfigurados 272
 - componentes 277
- COMBI 281
- BIN CART 282
 - preconfigurados 283
 - componentes 296



ESTANTERÍAS

302

- SYSTEM ST 302
- STORAGE DOMINO 304



CAJAS Y CONTENEDORES DE METAL

308

- CAJONES Y CONTENEDORES 309
- CONTENEDORES CON FONDO DE APERTURA 312
- CONTENEDORES DE FRENTE ABIERTO 313



CAJAS Y CONTENEDORES DE PLÁSTICO

314

- EURO BOX 315
- NESTABLE BOX LIGHT 319
- PICKING BOX 319
- VISUAL BOX 322
- MAT 323



MUEBLES PARA TALLER

324

GEAR GARAGE

- preconfigurados 333
- MÓDULOS 345
 - módulos córner 345
 - A= 714 mm 346
 - A= 1020 mm 348
 - A= 1428 mm 350
 - A= 1734 mm 353
 - A= 2040 mm 356
- PERFOM PUERTAS BATIENTES 361
 - A= 512 mm 361
 - A= 1023 mm 362
- PERFOM PUERTAS CORREDERAS 364
 - A= 1020 mm 364
 - A= 1427 mm 365
 - A= 2040 mm 366
- accesorios 369
- material de separación 370



- CONDICIONES GENERALES DE LA GARANTÍA 377
- CONDICIONES GENERALES DE VENTA 378

WORK MASTER BR

BANCOS DE TRABAJO

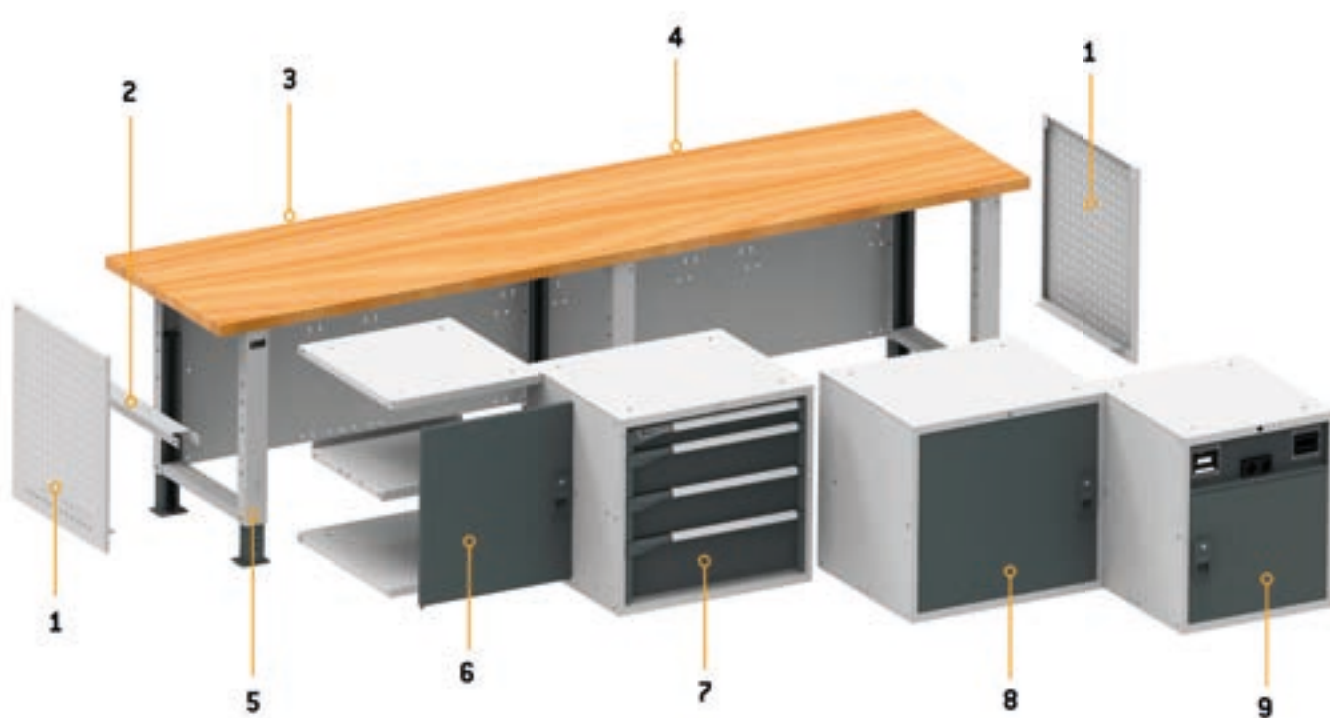

1. Panel perforado lateral
2. Soporte para medio estante intermedio
3. Cierre trasero
4. Encimera de multiplex
5. Patas regulables

6. Módulo componible
7. Armario con cajones
8. Armario con puerta
9. Armario técnico con puerta

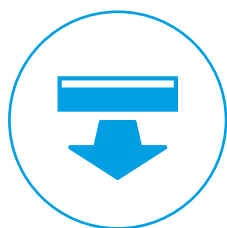

Cajones de extracción total

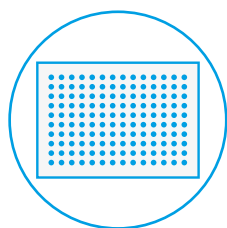

Fondo cajón perforado

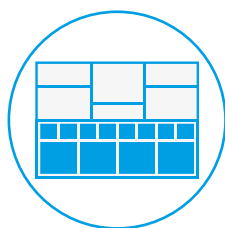

Material de separación



Cierre con llave

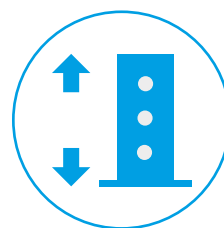

Patas de altura regulable

WORK MASTER BR



ART.	A mm	P mm	H mm	KG	RAL
MASTERBR2007	2206	750	1805/2180	1000	7035+7016

Compuesto por:





cant.	descripción	cant.	descripción
1	Banco desmontado con encimera de multiplex de 40 mm	2	Unidad de pared de apertura basculante sin cerradura
1	Armario A=560 mm con 4 cajones 1x75 2x150 1x200	2	Par de soportes de fijación de unidad de pared a los montantes
4	Estante superior/inferior A=560 mm	2	Barra de leds
1	Puerta total derecha H=600 mm con asa Dark Grey	2	Toma múltiple Schuko de 2 compartimentos
1	Puerta total izquierda H=600 mm con asa Dark Grey	1	Toma múltiple Schuko de 4 compartimentos
2	Soporte para medio estante intermedio	1	Magnetotérmico diferencial
2	Estante interno A=558 mm	1	Cable de conexión Wieland Schuko/FR
2	Panel perforado lateral	1	Bolsillo porta documentos A4
1	Panel perforado/repisa con borde bloquea caja	1	Kit porta rollo con papel Ø=240 mm
1	Kit 3 montantes con dos aletas	2	Porta bombonas inclinado de 2 puestos
1	Kit 2 paneles perforados/repisas con 1 borde bloquea caja	5	Gancho Unipok para herramientas - paquete de 30 unidades
1	Panel perforado electric	1	Canasta de 30 l de capacidad



RAL 7035 + RAL 7016



CAPACIDAD

-  **1000 kg**
-  **altura regulable**
-  **Encimera de multiplex espesor 40 mm**
-  **Se suministra desmontado**
-  **Paso orificios patas 25 mm**



ART.	A mm	P mm	H mm	RAL
MASTERBR1505	1500	750	740/1115	7035+7016

Compuesto por:

cant.	descripción
1	Banco desmontado con encimera de multiplex de 40 mm
1	Armario A=560 mm con 3 cajones 1x75 2x100
1	Par de escuadras de refuerzo



ART.	A mm	P mm	H mm	RAL
MASTERBR1506	1500	750	740/1115	7035+7016

Compuesto por:

cant.	descripción
1	Banco desmontado con encimera de multiplex de 40 mm
1	Armario A=560 mm con 4 cajones 1x75 2x150 1x200
1	Par de escuadras de refuerzo



ART.	A mm	P mm	H mm	RAL
MASTERBR1501	1500	750	740/1115	7035+7016

Compuesto por:

cant.	descripción
1	Banco desmontado con encimera de multiplex de 40 mm
1	Armario A=560 mm con 4 cajones 1x75 2x150 1x200
2	Medio estante adicional A=560 mm
1	Soporte para medio estante intermedio
2	Panel perforado lateral



WORK MASTER BR

1500

Ejemplos de configuración

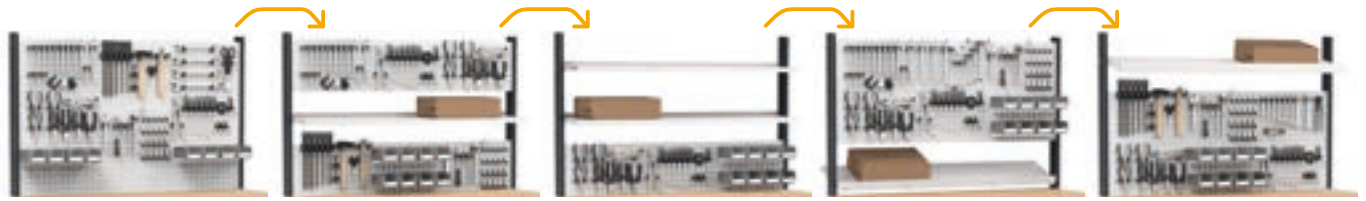

Herramientas excluidas



Herramientas excluidas



Herramientas excluidas



ART.	A mm	P mm	H mm	RAL	
MASTERBR1514	1500	750	1683/2058	7035+7016	

Compuesto por:

cant.	descripción
1	Banco desmontado con encimera de multiplex de 40 mm
1	Armario A=560 mm con 3 cajones 1x75 2x100
1	Par de escuadras de refuerzo
1	Kit de 2 montantes con dos aletas para bancos
1	Kit de 3 paneles perforados/repisas con 2 bordes bloquea caja
6	Gancho Unipok para herramientas - paquete de 30 unidades
2	Barra gancho con 4 contenedores Picking Box tamaño 1

ART.	A mm	P mm	H mm	RAL	
MASTERBR1515	1500	750	1683/2058	7035+7016	

Compuesto por:

cant.	descripción
1	Banco desmontado con encimera de multiplex de 40 mm
1	Armario A=560 mm con 4 cajones 1x75 2x150 1x200
1	Par de escuadras de refuerzo
1	Kit de 2 montantes con dos aletas para bancos
1	Kit de 3 paneles perforados/repisas con 2 bordes bloquea caja
6	Gancho Unipok para herramientas - paquete de 30 unidades
2	Barra gancho con 4 contenedores Picking Box tamaño 1

ART.	A mm	P mm	H mm	RAL	
MASTERBR1510	1500	750	1683/2058	7035+7016	





Compuesto por:

cant.	descripción
1	Banco desmontado con encimera de multiplex de 40 mm
2	Panel perforado lateral
1	Armario A=560 mm con 4 cajones 1x75 2x150 1x200
2	Medio estante adicional A=560 mm
1	Soporte para medio estante intermedio
1	Kit de 2 montantes con dos aletas para bancos
1	Kit de 3 paneles perforados/repisas con 2 bordes bloquea caja
6	Gancho Unipok para herramientas - paquete de 30 unidades
2	Barra gancho con 4 contenedores Picking Box tamaño 1



RAL 7035 + RAL 7016

CAPACIDAD

-  **1000 kg**
-  **altura regulable**
-  **Encimera de multiplex espesor 40 mm**
-  **Se suministra desmontado**
-  **Paso orificios patas 25 mm**



ART.	A mm	P mm	H mm	RAL
MASTERBR1502	1500	750	740/1115	7035+7016

Compuesto por:

cant.	descripción
1	Banco desmontado con encimera de multiplex de 40 mm
1	Armario A=560 mm con 4 cajones 1x75 2x150 1x200
2	Estante superior/inferior A=560 mm
1	Puerta total izquierda H=600 mm con asa Dark Grey
1	SopORTE para medio estante intermedio
1	Estante interno A=558 mm
2	Panel perforado lateral



ART.	A mm	P mm	H mm	RAL
MASTERBR1503	1500	750	740/1115	7035+7016

Compuesto por:

cant.	descripción
1	Banco desmontado con encimera de multiplex de 40 mm
1	Armario A=560 mm con 4 cajones 1x75 2x150 1x200
1	Armario A=560 mm con 5 cajones 1x75 3x100 1x200



ART.	A mm	P mm	H mm	RAL
MASTERBR1504	1500	750	740/1115	7035+7016

Compuesto por:

cant.	descripción
1	Banco desmontado con encimera de multiplex de 40 mm
2	Armario A=560 mm predispuesto para puerta con 1 cajón H=150 mm
1	Puerta parcial izquierda H=435 mm con asa Dark Grey
1	Puerta parcial derecha H=435 mm con asa Dark Grey



WORK MASTER BR

1500

Ejemplos de configuración



Herramientas excluidas



Herramientas excluidas



Herramientas excluidas



ART.	A mm	P mm	H mm	RAL	
MASTERBR1511	1500	750	1683/2058	7035+7016	

Compuesto por:

cant.	descripción
1	Banco desmontado con encimera de multiplex de 40 mm
2	Panel perforado lateral
1	Armario A=560 mm con 4 cajones 1x75 2x150 1x200
2	Estante superior/inferior A=560 mm
1	Puerta total izquierda H=600 mm con asa Dark Grey
1	Estante interno A=558 mm
1	Soporte para medio estante intermedio
1	Kit de 2 montantes con dos aletas para bancos
1	Kit de 3 paneles perforados/repisas con 2 bordes bloquea caja
6	Gancho Unipok para herramientas - paquete de 30 unidades
2	Barra gancho con 4 contenedores Picking Box tamaño 1

ART.	A mm	P mm	H mm	RAL	
MASTERBR1512	1500	750	1683/2058	7035+7016	

Compuesto por:

cant.	descripción
1	Banco desmontado con encimera de multiplex de 40 mm
1	Armario A=560 mm con 4 cajones 1x75 2x150 1x200
1	Armario A=560 mm con 5 cajones 1x75 3x100 1x200
1	Kit de 2 montantes con dos aletas para bancos
1	Kit de 3 paneles perforados/repisas con 2 bordes bloquea caja
6	Gancho Unipok para herramientas - paquete de 30 unidades
2	Barra gancho con 4 contenedores Picking Box tamaño 1

ART.	A mm	P mm	H mm	RAL	
MASTERBR1513	1500	750	1683/2058	7035+7016	





Compuesto por:

cant.	descripción
1	Banco desmontado con encimera de multiplex de 40 mm
2	Armario A=560 mm predispuesto para puerta con 1 cajón H=150 mm
1	Puerta parcial izquierda H=435 mm con asa Dark Grey
1	Puerta parcial derecha H=435 mm con asa Dark Grey
1	Kit de 2 montantes con dos aletas para bancos
1	Kit de 3 paneles perforados/repisas con 2 bordes bloquea caja
6	Gancho Unipok para herramientas - paquete de 30 unidades
2	Barra gancho con 4 contenedores Picking Box tamaño 1



RAL 7035 + RAL 7016

CAPACIDAD

-  **1000 kg**
-  **altura regulable**
-  **Encimera de multiplex espesor 40 mm**
-  **Se suministra desmontado**
-  **Paso orificios patas 25 mm**

ART.	A mm	P mm	H mm	RAL	
MASTERBR2005	2000	750	740/1115	7035+7016	

Compuesto por:

cant.	descripción
1	Banco desmontado con encimera de multiplex de 40 mm
1	Armario A=560 mm con 3 cajones 1x75 2x100
1	Par de escuadras de refuerzo



ART.	A mm	P mm	H mm	RAL	
MASTERBR2006	2000	750	740/1115	7035+7016	

Compuesto por:

cant.	descripción
1	Banco desmontado con encimera de multiplex de 40 mm
1	Armario A=560 mm con 4 cajones 1x75 2x150 1x200
1	Par de escuadras de refuerzo



ART.	A mm	P mm	H mm	RAL	
MASTERBR2001	2000	750	740/1115	7035+7016	

Compuesto por:

cant.	descripción
1	Banco desmontado con encimera de multiplex de 40 mm
1	Armario A=560 mm con 4 cajones 1x75 2x150 1x200
1	Armario A=560 mm predispuesto para puerta con 1 estante regulable
1	Puerta total izquierda H=600 mm con asa Dark Grey
2	Medio estante adicional A=560 mm



Ejemplos de configuración

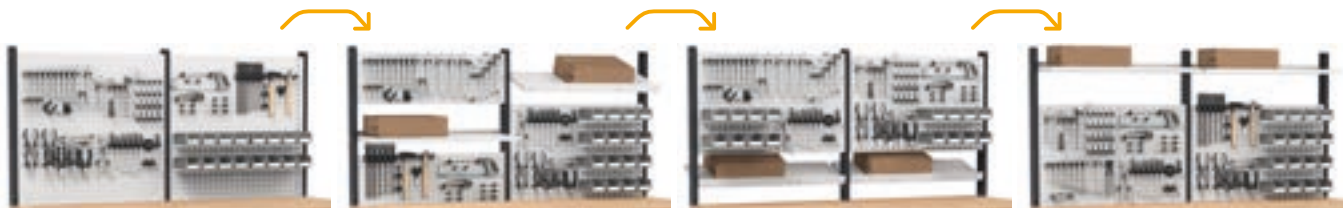

Herramientas excluidas



Herramientas excluidas



Herramientas excluidas



ART.	A mm	P mm	H mm	RAL	
MASTERBR2013	2000	750	1683/2058	7035+7016	

Compuesto por:

cant.	descripción
1	Banco desmontado con encimera de multiplex de 40 mm
1	Armario A=560 mm con 3 cajones 1x75 2x100
1	Par de escuadras de refuerzo
1	Kit 3 montantes con dos aletas
2	Kit de 3 paneles perforados/repisas con 2 bordes bloquea caja
6	Gancho Unipok para herramientas - paquete de 30 unidades
4	Barra gancho con 4 contenedores Picking Box tamaño 1

ART.	A mm	P mm	H mm	RAL	
MASTERBR2014	2000	750	1683/2058	7035+7016	

Compuesto por:





cant.	descripción
1	Banco desmontado con encimera de multiplex de 40 mm
1	Armario A=560 mm con 4 cajones 1x75 2x150 1x200
1	Par de escuadras de refuerzo
1	Kit 3 montantes con dos aletas
2	Kit de 3 paneles perforados/repisas con 2 bordes bloquea caja
6	Gancho Unipok para herramientas - paquete de 30 unidades
4	Barra gancho con 4 contenedores Picking Box tamaño 1

ART.	A mm	P mm	H mm	RAL	
MASTERBR2009	2000	750	1683/2058	7035+7016	

Compuesto por:

cant.	descripción
1	Banco desmontado con encimera de multiplex de 40 mm
1	Armario A=560 mm predispuesto para puerta con 1 estante regulable
1	Puerta total izquierda H=600 mm con asa Dark Grey
1	Armario A=560 mm con 4 cajones 1x75 2x150 1x200
2	Medio estante adicional A=560 mm
1	Kit 3 montantes con dos aletas
2	Kit de 3 paneles perforados/repisas con 2 bordes bloquea caja
6	Gancho Unipok para herramientas - paquete de 30 unidades
4	Barra gancho con 4 contenedores Picking Box tamaño 1



-  **1000 kg**
-  **altura regulable**
-  **Encimera de multiplex espesor 40 mm**
-  **Se suministra desmontado**
-  **Paso orificios patas 25 mm**



ART.	A mm	P mm	H mm	RAL	
MASTERBR2002	2000	750	740/1115	7035+7016	

Compuesto por:

cant.	descripción
1	Banco desmontado con encimera de multiplex de 40 mm
1	Armario A=560 mm con 4 cajones 1x75 2x150 1x200
1	Armario A=560 mm con 5 cajones 1x75 3x100 1x200
2	Medio estante adicional A=560 mm



ART.	A mm	P mm	H mm	RAL	
MASTERBR2003	2000	750	740/1115	7035+7016	

Compuesto por:

cant.	descripción
1	Banco desmontado con encimera de multiplex de 40 mm
1	Armario A=560 mm con 5 cajones 1x75 3x100 1x200
4	Estante superior/inferior A=560 mm
1	Puerta total derecha H=600 mm con asa Dark Grey
1	Puerta total izquierda H=600 mm con asa Dark Grey
2	Soporte para medio estante intermedio
2	Estante interno A=558 mm
2	Panel perforado lateral



ART.	A mm	P mm	H mm	RAL	
MASTERBR2004	2000	750	740/1115	7035+7016	

Compuesto por:

cant.	descripción
1	Banco desmontado con encimera de multiplex de 40 mm
3	Armario A=560 mm predispuesto para puerta con 1 cajón H=150 mm
1	Puerta parcial derecha H=435 mm con asa Dark Grey
2	Puerta parcial izquierda H=435 mm con asa Dark Grey



Ejemplos de configuración

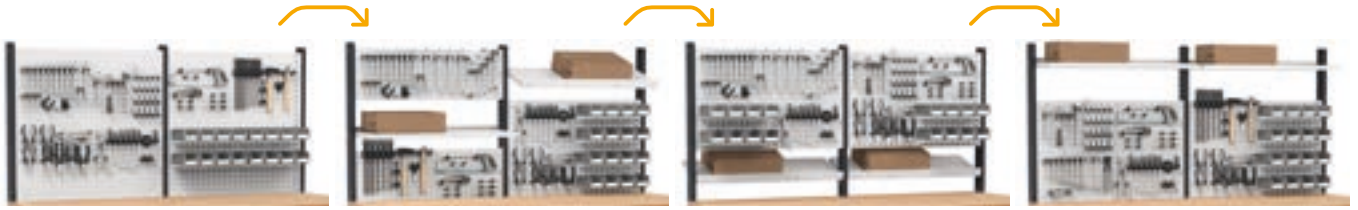

Herramientas excluidas



Herramientas excluidas



Herramientas excluidas



ART.	A mm	P mm	H mm	RAL	
MASTERBR2010	2000	750	1683/2058	7035+7016	

Compuesto por:

cant.	descripción
1	Banco desmontado con encimera de multiplex de 40 mm
1	Armario A=560 mm con 5 cajones 1x75 3x100 1x200
1	Armario A=560 mm con 4 cajones 1x75 2x150 1x200
2	Medio estante adicional A=560 mm
1	Kit 3 montantes con dos aletas
2	Kit de 3 paneles perforados/repisas con 2 bordes bloquea caja
6	Gancho Unipok para herramientas - paquete de 30 unidades
4	Barra gancho con 4 contenedores Picking Box tamaño 1

ART.	A mm	P mm	H mm	RAL	
MASTERBR2011	2000	750	1683/2058	7035+7016	

Compuesto por:

cant.	descripción
1	Banco desmontado con encimera de multiplex de 40 mm
4	Estante superior/inferior A=560 mm
1	Puerta total izquierda H=600 mm con asa Dark Grey
1	Puerta total derecha H=600 mm con asa Dark Grey
2	Estante interno A=558 mm
2	Soporte para medio estante intermedio
1	Armario A=560 mm con 5 cajones 1x75 3x100 1x200
2	Panel perforado lateral
1	Kit 3 montantes con dos aletas
2	Kit de 3 paneles perforados/repisas con 2 bordes bloquea caja
6	Gancho Unipok para herramientas - paquete de 30 unidades
4	Barra gancho con 4 contenedores Picking Box tamaño 1

ART.	A mm	P mm	H mm	RAL	
MASTERBR2012	2000	750	1683/2058	7035+7016	

Compuesto por:



cant.	descripción
1	Banco desmontado con encimera de multiplex de 40 mm
3	Armario A=560 mm predispuesto para puerta con 1 cajón H=150 mm
2	Puerta parcial izquierda H=435 mm con asa Dark Grey
1	Puerta parcial derecha H=435 mm con asa Dark Grey
1	Kit 3 montantes con dos aletas
2	Kit de 3 paneles perforados/repisas con 2 bordes bloquea caja
6	Gancho Unipok para herramientas - paquete de 30 unidades
4	Barra gancho con 4 contenedores Picking Box tamaño 1



RAL 7035 + RAL 7016



CAPACIDAD

-  **1000 kg**
-  **altura regulable**
-  **Encimera de multiplex espesor 40 mm**
-  **Se suministra desmontado**
-  **Paso orificios patas 25 mm**



ART.	A mm	P mm	H mm	encimera		RAL	
				material	mm		
MBR01S0V0V001PD	1024	750	740/1115	Multiplex	40	7035+7016	



ART.	A mm	P mm	H mm	encimera		RAL	
				material	mm		
MBR02S0V0V001PD	1500	750	740/1115	Multiplex	40	7035+7016	



ART.	A mm	P mm	H mm	encimera		RAL	
				material	mm		
MBR03S0V0V001PD	2000	750	740/1115	Multiplex	40	7035+7016	



ART.	A mm	P mm	H mm	encimera		RAL	
				material	mm		
MBR04S0V0V001PD	3000	750	740/1115	Multiplex	40	7035+7016	



Embalaje banco desmontado



Par de escuadras de refuerzo

ART.	A mm	P mm	H mm	RAL	
FBGKITS0008	145	39	145	7035	

 Utilizar una escuadra por cada pata si no hay una cajonera o un estante (un par para los bancos 1024/1500/2000, dos pares para los bancos 3000)



Cobertura para encimera de multiplex

ART.	A mm	P mm	H mm	color	
FBL22300007	1028	754	22	Negro	
FBL22600007	1504	754	22	Negro	
FBL22900007	2004	754	22	Negro	
FBL23200007	3004	754	22	Negro	

Esquema técnico

A → 1000 mm



A → 1500 mm



A → 2000 mm



A → 3000 mm



RAL 7035 + RAL 7016



RAL 7035



CAPACIDAD



ESPESOR

Armarios con cajones

A  560 mm

27x27 EH

Armario con 3 cajones





ART.	A mm	P mm	H mm	cajones					RAL	
				n.º	h 75 mm	h 100 mm				
MBR05SC010203PD	560	610	369	3	1	2	100-75-50	92-96-100%	7035+7016	



Armario con 4 cajones





ART.	A mm	P mm	H mm	cajones					RAL		
				n.º	h 75 mm	h 150 mm	h 200 mm				
MBR05SC010204PD	560	610	669	4	1	2	1	100-75-50	92-96-100%	7035+7016	



Armario con 5 cajones



ART.	A mm	P mm	H mm	cajones					RAL		
				n.º	h 75 mm	h 100 mm	h 200 mm				
MBR05SC010205PD	560	610	669	5	1	3	1	100-75-50	92-96-100%	7035+7016	



Armario con estante intermedio preparado para puertas



ART.	A mm	P mm	H mm	estante regulable	RAL	
MBR05SX00020708	560	610	669	1	7035	

Puerta total izquierda H=600 mm con asa Dark Grey



ART.	A mm	P mm	H mm	Apertura	RAL	
MBR06SC01020239	504	34	600	izq.	7016	

Puerta total derecha H=600 mm con asa Dark Grey



ART.	A mm	P mm	H mm	Apertura	RAL	
MBR06SC01020139	504	34	600	dcha.	7016	

Armarios con cajones

A  560 mm

27x27 EH



Armario técnico A=560 mm predispuesto para puerta

Adecuado para puertas Art. MBR06SC01020339 y Art. MBR06SC01020439

ART.	A mm	P mm	H mm	RAL
MBR05SX000208PD	560	610	669	7035+7016



Enrollador eléctrico con toma Schuko

ART.	Longitud del cable (m)	Tipo de toma	Volt	Watt
MBR13S0V0V00100	20	Schuko	230	1600



Enrollador para aire comprimido

ART.	Longitud del cable (m)	Presión máx. Mpa	Ø mm
MBR13S0V0V00200	14	1,5	10



Rodillo para enrollador

ART.
MBR13S0V0V00339



Placa para enrollador

Para fijar a la parte posterior del armario

ART.
MBR13S0V0V00499

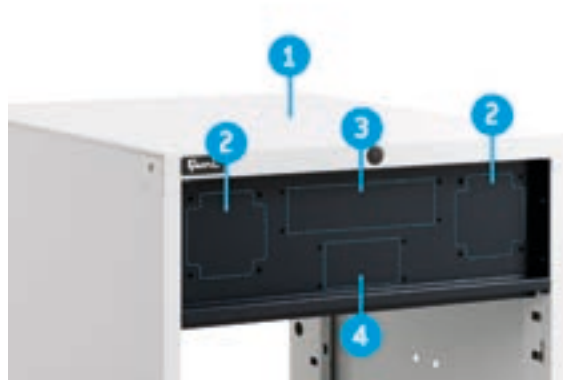

1. Armario técnico A=560 mm predispuesto para puerta
2. Módulo: Rodillo para enrollador

3. Módulo: Toma múltiple de 4 puestos
4. Módulo: Toma múltiple de 2 puestos



RAL 7035 + RAL 7016



RAL 7016



RAL 7035



EXTRACCIÓN



CAPACIDAD



Armarios con cajones

A  560 mm

27x27 EH



Armario A=560 mm predispuesto para puerta con 1 cajón H=150 mm

ART.	A mm	P mm	H mm	cajones			RAL	
				h 150 mm				
MBR05SC010206PD	560	610	669	1	100-75-50	92-96-100%	7035+7016	



Puerta parcial izquierda H=435 mm con asa Dark Grey

ART.	A mm	P mm	H mm	Apertura	RAL	
MBR06SC01020439	504	34	435	izq.	7016	



Puerta parcial derecha H=435 mm con asa Dark Grey

ART.	A mm	P mm	H mm	Apertura	RAL	
MBR06SC01020339	504	34	435	dcha.	7016	



Armarios con cajones

A  713 mm

36x27 EH





Armario A=713 mm con 4 cajones 1x75 2x150 1x200

ART.	A mm	P mm	H mm	cajones						RAL	
				n.º	h 75 mm	h 150 mm	h 200 mm				
MBR05SC010304PD	713	610	669	4	1	2	1	100-75-50	92-96-100%	7035+7016	



Armario A=713 mm con 5 cajones 1x75 3x100 1x200

ART.	A mm	P mm	H mm	cajones						RAL	
				n.º	h 75 mm	h 100 mm	h 200 mm				
MBR05SC010305PD	713	610	669	5	1	3	1	100-75-50	92-96-100%	7035+7016	



Armarios con cajones

A  713 mm

36x27 EH



Armario A=713 mm predispuesto para puerta con 1 estante regulable

ART.	A mm	P mm	H mm	RAL	
MBR05SX00030708	713	610	669	7035	



Puerta total izquierda H=600 mm con asa Dark Grey

ART.	A mm	P mm	H mm	Apertura	RAL	
MBR06SC01030239	657	34	600	izq.	7016	





Puerta total derecha H=600 mm con asa Dark Grey

ART.	A mm	P mm	H mm	Apertura	RAL	
MBR06SC01030139	657	34	600	dcha.	7016	



Armario A=713 mm predispuesto para puerta con 1 cajón H=150 mm

ART.	A mm	P mm	H mm	cajones			RAL	
				h 150 mm	 KG			
MBR05SC010306PD	713	610	669	1	100-75-50	92-96-100%	7035+7016	



Puerta parcial izquierda H=435 mm con asa Dark Grey

ART.	A mm	P mm	H mm	Apertura	RAL	
MBR06SC01030439	657	34	435	izq.	7016	



Puerta parcial derecha H=435 mm con asa Dark Grey

ART.	A mm	P mm	H mm	Apertura	RAL	
MBR06SC01030339	657	34	435	dcha.	7016	



RAL 7035 + RAL 7016



RAL 7016



RAL 7035



EXTRACCIÓN



CAPACIDAD



Panel perforado lateral

ART.	A mm	P mm	H mm	Medida del orificio (mm)	RAL	
FBG15S00V0V0008	610	75	669	10x10	7035	



Estante adicional

ART.	A mm	P mm	H mm	KG	RAL	
MBR08S070600008	713	605	35	250	7035	
MBR08S090600008	967	605	35	250	7035	
MBR08S110600008	1120	605	35	250	7035	
MBR08S120600008	1273	605	35	250	7035	
MBR08S160600008	1680	605	35	200	7035	



Medio estante adicional

ART.	A mm	P mm	H mm	KG	RAL	
MBR09S050300008	560	305	35	100	7035	
MBR09S070300008	713	305	35	100	7035	
MBR09S090300008	967	305	35	100	7035	
MBR09S110300008	1120	305	35	100	7035	
MBR09S120300008	1273	305	35	100	7035	
MBR09S160300008	1680	305	35	100	7035	



Soporte para medio estante intermedio

ART.	A mm	P mm	H mm	RAL	
FBG13S605V00008	605	77	35	7035	

Módulo componible



1. Estante interno 27x27 EH
2. Estante superior e inferior 27x27 EH
3. Soporte para medio estante intermedio
4. Puerta total derecha H=600 mm con asa Dark Grey
5. Puerta total izquierda H=600 mm con asa Dark Grey

Estante interno 27x27 EH

ART.	A mm	P mm	H mm	KG	RAL	
MBR11S0V0020008	558	466	60	100	7035	



Estante superior e inferior 27x27 EH

ART.	A mm	P mm	H mm	KG	RAL	
MBR10S050600008	560	610	32	100	7035	



Puerta total derecha H=600 mm con asa Dark Grey

ART.	A mm	P mm	H mm	Apertura	RAL	
MBR06SC01020539	554	34	600	dcha.	7016	



Soporte para medio estante intermedio

ART.	A mm	P mm	H mm	RAL	
FBG13S605V00008	605	77	35	7035	



Puerta total izquierda H=600 mm con asa Dark Grey

ART.	A mm	P mm	H mm	Apertura	RAL	
MBR06SC01020639	554	34	600	izq.	7016	



WORK MASTER BR MATERIAL DE SEPARACIÓN

A= 560 MM 27X27 EH

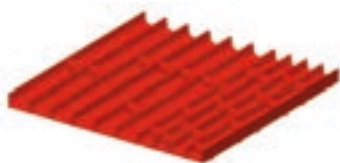

ART.	apto para cajón H mm	componentes	
FFH84050200	50/300	16 x Divisor transversal A=36 mm 7 x Divisor transversal A=47 mm 6 x Divisor de 3 canales 3 x Divisor de 4 canales	

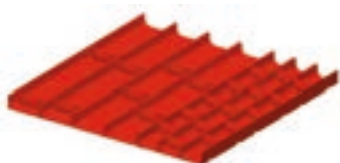

ART.	apto para cajón H mm	componentes	
FFH84050300	50/300	15 x Divisor transversal A=47 mm 8 x Divisor transversal A=73 mm 6 x Divisor de 2 canales 3 x Divisor de 3 canales	

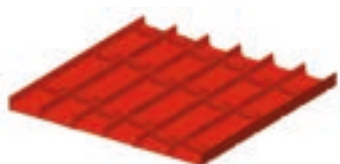

ART.	apto para cajón H mm	componentes	
FFH84050400	50/300	18 x Divisor transversal A=73 mm 9 x Divisor de 2 canales	

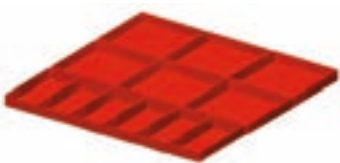

ART.	apto para cajón H mm	componentes	
FFH84071800	75	6 x Caja divisor 150x75 mm	
FFH84101800	100/125	6 x Caja divisor 150x150 mm	



ART.	apto para cajón H mm	componentes	
FFH84070800	75		
FFH84100800	100/125	2 x Divisor longitudinal ranurado A=457 mm 3 x Divisor transversal A=151 mm	
FFH84150800	150/175		
FFH84200800	200/250		

WORK MASTER BR MATERIAL DE SEPARACIÓN

A= 713 MM 36X27 EH

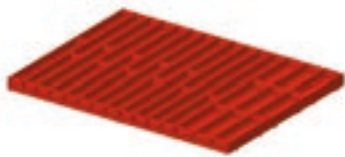

ART.	apto para cajón H mm	componentes	
FFH10051000	50/300	3 x Divisor de 3 canales 9 x Divisor de 4 canales 12 x Divisor transversal A=47 mm 36 x Divisor transversal A=36 mm	

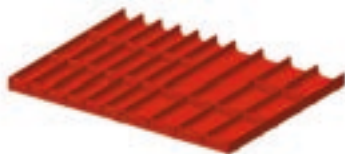

ART.	apto para cajón H mm	componentes	
FFH10051300	50/300	18 x Divisor transversal A=47 mm 12 x Divisor transversal A=73 mm 6 x Divisor de 2 canales 6 x Divisor de 3 canales	

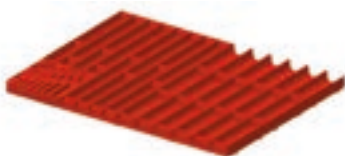

ART.	apto para cajón H mm	componentes	
FFH10051500	50/300	20 x Divisor transversal A=36 mm 20 x Divisor transversal A=47 mm 6 x Divisor de 3 canales 5 x Divisor de 4 canales 1 x Porta llaves Allen	

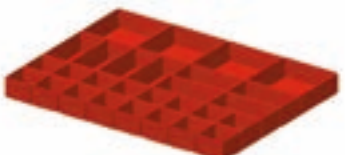

ART.	apto para cajón H mm	componentes	
FFH10071800	75	16 x Caja divisor 75x75 mm 8 x Caja divisor 150x75 mm 4 x Caja divisor 150x150 mm	

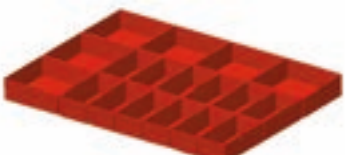

ART.	apto para cajón H mm	componentes	
FFH10071600	75	12 x Caja divisor 150x75 mm	
FFH10101600	100/125	6 x Caja divisor 150x150 mm	



ART.	apto para cajón H mm	componentes	
FFH10070500	75		
FFH10100500	100/125	2 x Separador longitudinal ranurado A=457 mm	
FFH10150500	150/175	3 x Divisor transversal A=202 mm	
FFH10200500	200/250		

WORK MASTER BR



ART.	A mm	P mm	H mm	KG	RAL
MASTERBR3001	3206	750	1985/2360	1000	7035+7016

Compuesto por:

cant.	descripción
1	Banco desmontado con encimera de multiplex de 40 mm
1	Armario A=560 mm predispuesto para puerta con 1 estante regulable
2	Armario A=713 mm con 4 cajones 1x75 2x150 1x200
1	Armario técnico A=560 mm predispuesto para puerta
1	Puerta parcial derecha H=435 mm con asa Dark Grey
1	Puerta total izquierda H=600 mm con asa Dark Grey
2	Panel perforado lateral
1	Kit 3 montantes con dos aletas
2	Kit de 3 paneles perforados/repisas con 2 bordes bloquea caja
2	Lámpara doble
2	Armario colgante con puerta
1	Toma múltiple Schuko de 2 compartimentos
1	Cable de conexión Wieland Schuko/FR

cant.	descripción
1	Bolsillo porta documentos A4
1	Kit porta rollo con papel Ø=240 mm
4	Porta bombonas inclinado de 2 puestos
6	Gancho Unipok para herramientas - paquete de 30 unidades
1	Barra gancho con 4 contenedores Picking Box tamaño 1
2	Repisa grande reversible
1	Canasta de 30 l de capacidad
3	Kit de 2 contenedores Picking Box tamaño 3A2
1	Placa para enrollador
2	Rodillo para enrollador
1	Enrollador para aire comprimido
1	Enrollador eléctrico con toma Schuko
1	Kit de 3 soportes inclinados con 2 guías



WORK MASTER BR



ART.	A mm	P mm	H mm	KG	RAL
MASTERBR1508	1706	750	1985/2360	1000	7035+7016

Compuesto por:

cant.	descripción
1	Banco desmontado con encimera de multiplex de 40 mm
1	Armario A=560 mm con 5 cajones 1x75 3x100 1x200
2	Estante superior/inferior A=560 mm
1	Puerta total izquierda H=600 mm con asa Dark Grey
1	Soporte para medio estante intermedio
1	Estante interno A=558 mm
2	Panel perforado lateral
1	Soporte toma múltiple de 2 compartimentos
1	Soporte toma múltiple de 4 compartimentos
1	Toma múltiple Schuko de 2 compartimentos
1	Toma múltiple Schuko de 4 compartimentos

cant.	descripción
1	Cable de conexión Wieland Schuko/FR
1	Bolsillo porta documentos A4
1	Kit porta rollo con papel Ø=240 mm
2	Porta bombonas inclinado de 2 puestos
4	Gancho Unipok para herramientas - paquete de 30 unidades
1	Canasta de 30 l de capacidad
2	Armario colgante con puerta
1	Lámpara doble
1	Kit de 3 paneles perforados/repisas con 2 bordes bloquea caja
1	Kit de 2 soportes inclinados con guía
1	Kit de 2 montantes con dos aletas para bancos

 RAL 7035 + RAL 7016 CAPACIDAD

WORK-WORK UP

BANCOS DE TRABAJO

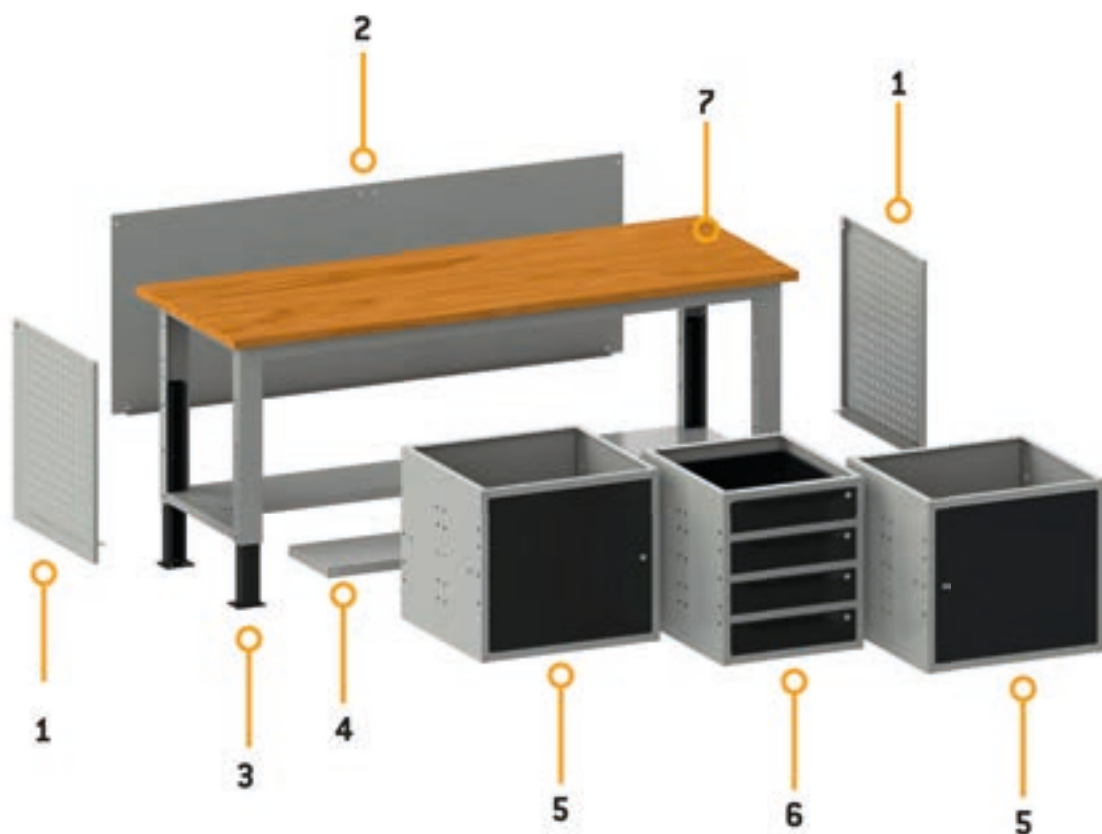

1. Panel perforado lateral
2. Cierre trasero
3. Patas regulables
4. Medio estante adicional

5. Armario con puerta
6. Armario con 4 cajones
7. Encimera de multiplex



Cajones de extracción simple

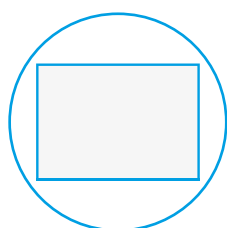

Fondo cajón liso

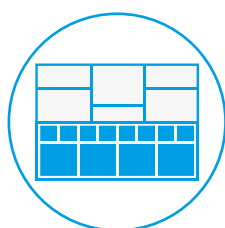

Material de separación



Cierre con llave

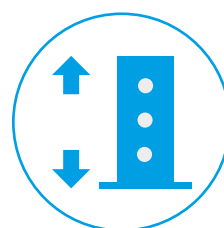

Patas de altura regulable

Configuraciones alternativas



Herramientas excluidas



ART.	A mm	P mm	H mm	KG	RAL	
WORK2043	2307	750	1977/2352	1000	7035+7016	

Compuesto por:



cant.	descripción	cant.	descripción
1	Banco desmontado regulable con encimera de multiplex 30 mm	2	Kit de 3 paneles perforados/repisas con 2 bordes bloquea caja
2	Armario A=629 mm con 1 puerta y 1 estante regulable	1	Lámpara doble
1	Armario A=500 mm con 3 cajones H=150 mm	2	Porta bombonas inclinado de 2 puestos
1	Medio estante no ranurado A=1760 mm	1	Kit porta rollo con papel Ø=240 mm
2	Panel perforado lateral	7	Gancho Unipok para herramientas - paquete de 30 unidades
1	Canasta de 30 l de capacidad	1	Soporte toma múltiple de 4 compartimentos
2	Porta silicona inclinado de 2 puestos	1	Toma múltiple Schuko de 4 compartimentos
1	Bolsillo porta documentos A4	1	Cable de conexión Wieland Schuko/FR
1	Kit 3 montantes con dos aletas	1	Repisa grande reversible
1	Kit de 3 soportes inclinados con 2 guías		



RAL 7035 + RAL 7016



CAPACIDAD

-  **1000 kg**
-  **altura regulable**
-  **Encimera de multiplex espesor 30 mm**
-  **Se suministra desmontado**
-  **Paso orificios patas 25 mm**



ART.	A mm	P mm	H mm	RAL	
WORK1501	1500	750	732/1107	7035+7016	
WORK1502	1500	750	732/1107	5012	

Compuesto por:

cant.	descripción
1	Banco desmontado regulable con encimera de multiplex 30 mm
1	Armario A=500 mm con 1 cajón H=150 mm



ART.	A mm	P mm	H mm	RAL	
WORK1503	1500	750	732/1107	7035+7016	
WORK1504	1500	750	732/1107	5012	

Compuesto por:

cant.	descripción
1	Banco desmontado regulable con encimera de multiplex 30 mm
1	Armario A=500 mm con 4 cajones H=105 mm
1	Medio estante no ranurado A=1260 mm



ART.	A mm	P mm	H mm	RAL	
WORK1507	1500	750	732/1107	7035+7016	
WORK1508	1500	750	732/1107	5012	

Compuesto por:

cant.	descripción
1	Banco desmontado regulable con encimera de multiplex 30 mm
1	Armario A=500 mm con 4 cajones H=105 mm
1	Cierre trasero
1	Medio estante no ranurado A=760 mm
1	Soporte para medio estante intermedio

WORK UP 1500

Ejemplos de configuración



Herramientas excluidas



Herramientas excluidas



Herramientas excluidas



ART.	A mm	P mm	H mm	RAL
WORK1528	1500	750	1675/2050	7035+7016
WORK1534	1500	750	1675/2050	5012

Compuesto por:

cant.	descripción
1	Banco desmontado regulable con encimera de multiplex 30 mm
1	Armario A=500 mm con 1 cajón H=150 mm
1	Kit de 2 montantes con dos aletas para bancos
1	Kit de 3 paneles perforados/repisas con 2 bordes bloquea caja
6	Gancho Unipok para herramientas - paquete de 30 unidades
2	Barra gancho con 4 contenedores Picking Box tamaño 1

ART.	A mm	P mm	H mm	RAL
WORK1529	1500	750	1675/2050	7035+7016
WORK1535	1500	750	1675/2050	5012

Compuesto por:

cant.	descripción
1	Banco desmontado regulable con encimera de multiplex 30 mm
1	Armario A=500 mm con 4 cajones H=105 mm
1	Medio estante no ranurado A=1260 mm
1	Kit de 2 montantes con dos aletas para bancos
1	Kit de 3 paneles perforados/repisas con 2 bordes bloquea caja
6	Gancho Unipok para herramientas - paquete de 30 unidades
2	Barra gancho con 4 contenedores Picking Box tamaño 1





ART.	A mm	P mm	H mm	RAL
WORK1530	1500	750	1675/2050	7035+7016
WORK1536	1500	750	1675/2050	5012

Compuesto por:

cant.	descripción
1	Banco desmontado regulable con encimera de multiplex 30 mm
1	Cierre trasero
1	Armario A=500 mm con 4 cajones H=105 mm
1	Medio estante no ranurado A=760 mm
1	Soporte para medio estante intermedio
1	Kit de 2 montantes con dos aletas para bancos
1	Kit de 3 paneles perforados/repisas con 2 bordes bloquea caja
6	Gancho Unipok para herramientas - paquete de 30 unidades
2	Barra gancho con 4 contenedores Picking Box tamaño 1



 RAL 5012 RAL 7035+RAL 7016

-  **1000 kg**
-  **altura regulable**
-  **Encimera de multiplex espesor 30 mm**
-  **Se suministra desmontado**
-  **Paso orificios patas 25 mm**



ART.	A mm	P mm	H mm	RAL	
WORK1505	1500	750	732/1107	7035+7016	
WORK1506	1500	750	732/1107	5012	

Compuesto por:

cant.	descripción
1	Banco desmontado regulable con encimera de multiplex 30 mm
1	Armario A=500 mm con 4 cajones H=105 mm
1	Armario A=500 mm con 1 puerta y 1 estante regulable
1	Fondo de cierre para armario A=500 mm



ART.	A mm	P mm	H mm	RAL	
WORK1511	1500	750	732/1107	7035+7016	
WORK1512	1500	750	732/1107	5012	

Compuesto por:

cant.	descripción
1	Banco desmontado regulable con encimera de multiplex 30 mm
2	Armario A=629 mm con 1 cajón H=150 mm y 1 puerta
1	Medio estante no ranurado A=1260 mm



ART.	A mm	P mm	H mm	RAL	
WORK1509	1500	750	732/1107	7035+7016	
WORK1510	1500	750	732/1107	5012	

Compuesto por:

cant.	descripción
1	Banco desmontado regulable con encimera de multiplex 30 mm
1	Armario A=629 mm con 4 cajones H=105 mm
1	Armario A=629 mm con 1 puerta y 1 estante regulable
1	Medio estante no ranurado A=1260 mm

WORK UP 1500

Ejemplos de configuración



Herramientas excluidas



Herramientas excluidas



Herramientas excluidas



ART.	A mm	P mm	H mm	RAL
WORK1531	1500	750	1675/2050	7035+7016
WORK1537	1500	750	1675/2050	5012

Compuesto por:

cant.	descripción
1	Banco desmontado regulable con encimera de multiplex 30 mm
1	Armario A=500 mm con 1 puerta y 1 estante regulable
1	Fondo de cierre para armario A=500 mm
1	Armario A=500 mm con 4 cajones H=105 mm
1	Kit de 2 montantes con dos aletas para bancos
1	Kit de 3 paneles perforados/repisas con 2 bordes bloquea caja
6	Gancho Unipok para herramientas - paquete de 30 unidades
2	Barra gancho con 4 contenedores Picking Box tamaño 1

ART.	A mm	P mm	H mm	RAL
WORK1532	1500	750	1675/2050	7035+7016
WORK1538	1500	750	1675/2050	5012

Compuesto por:

cant.	descripción
1	Banco desmontado regulable con encimera de multiplex 30 mm
2	Armario A=629 mm con 1 cajón H=150 mm y 1 puerta
1	Medio estante no ranurado A=1260 mm
1	Kit de 2 montantes con dos aletas para bancos
1	Kit de 3 paneles perforados/repisas con 2 bordes bloquea caja
6	Gancho Unipok para herramientas - paquete de 30 unidades
2	Barra gancho con 4 contenedores Picking Box tamaño 1





ART.	A mm	P mm	H mm	RAL
WORK1533	1500	750	1675/2050	7035+7016
WORK1539	1500	750	1675/2050	5012

Compuesto por:

cant.	descripción
1	Banco desmontado regulable con encimera de multiplex 30 mm
1	Armario A=629 mm con 1 puerta y 1 estante regulable
1	Armario A=629 mm con 4 cajones H=105 mm
1	Medio estante no ranurado A=1260 mm
1	Kit de 2 montantes con dos aletas para bancos
1	Kit de 3 paneles perforados/repisas con 2 bordes bloquea caja
6	Gancho Unipok para herramientas - paquete de 30 unidades
2	Barra gancho con 4 contenedores Picking Box tamaño 1



 RAL 5012 RAL 7035+RAL 7016

-  **1000 kg**
-  **altura regulable**
-  **Encimera de multiplex espesor 30 mm**
-  **Se suministra desmontado**
-  **Paso orificios patas 25 mm**



ART.	A mm	P mm	H mm	RAL
WORK2001	2000	750	732/1107	7035+7016
WORK2002	2000	750	732/1107	5012

Compuesto por:

cant.	descripción
1	Banco desmontado regulable con encimera de multiplex 30 mm
1	Armario A=500 mm con 1 cajón H=150 mm



ART.	A mm	P mm	H mm	RAL
WORK2003	2000	750	732/1107	7035+7016
WORK2004	2000	750	732/1107	5012

Compuesto por:

cant.	descripción
1	Banco desmontado regulable con encimera de multiplex 30 mm
1	Armario A=500 mm con 4 cajones H=105 mm
1	Medio estante no ranurado A=1760 mm



ART.	A mm	P mm	H mm	RAL
WORK2005	2000	750	732/1107	7035+7016
WORK2006	2000	750	732/1107	5012

Compuesto por:

cant.	descripción
1	Banco desmontado regulable con encimera de multiplex 30 mm
1	Armario A=500 mm con 4 cajones H=105 mm
1	Armario A=500 mm con 1 puerta y 1 estante regulable
1	Medio estante no ranurado A=1760 mm

WORK UP 2000

Ejemplos de configuración

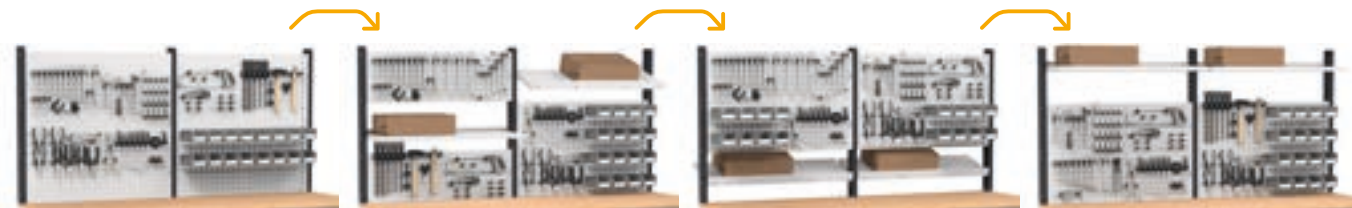

Herramientas excluidas



Herramientas excluidas



Herramientas excluidas



ART.	A mm	P mm	H mm	RAL
WORK2030	2000	750	1675/2050	7035+7016
WORK2036	2000	750	1675/2050	5012

Compuesto por:

cant.	descripción
1	Banco desmontado regulable con encimera de multiplex 30 mm
1	Armario A=500 mm con 1 cajón H=150 mm
1	Kit 3 montantes con dos aletas
2	Kit de 3 paneles perforados/repisas con 2 bordes bloquea caja
6	Gancho Unipok para herramientas - paquete de 30 unidades
4	Barra gancho con 4 contenedores Picking Box tamaño 1

ART.	A mm	P mm	H mm	RAL
WORK2031	2000	750	1675/2050	7035+7016
WORK2037	2000	750	1675/2050	5012

Compuesto por:

cant.	descripción
1	Banco desmontado regulable con encimera de multiplex 30 mm
1	Armario A=500 mm con 4 cajones H=105 mm
1	Medio estante no ranurado A=1760 mm
1	Kit 3 montantes con dos aletas
2	Kit de 3 paneles perforados/repisas con 2 bordes bloquea caja
6	Gancho Unipok para herramientas - paquete de 30 unidades
4	Barra gancho con 4 contenedores Picking Box tamaño 1



ART.	A mm	P mm	H mm	RAL
WORK2032	2000	750	1675/2050	7035+7016
WORK2038	2000	750	1675/2050	5012



Compuesto por:

cant.	descripción
1	Banco desmontado regulable con encimera de multiplex 30 mm
1	Armario A=500 mm con 1 puerta y 1 estante regulable
1	Armario A=500 mm con 4 cajones H=105 mm
1	Medio estante no ranurado A=1760 mm
1	Kit 3 montantes con dos aletas
2	Kit de 3 paneles perforados/repisas con 2 bordes bloquea caja
6	Gancho Unipok para herramientas - paquete de 30 unidades
4	Barra gancho con 4 contenedores Picking Box tamaño 1



 RAL 5012 RAL 7035+RAL 7016

 **1000 kg**
 **altura regulable**
 **Encimera de multiplex espesor 30 mm**

 **Se suministra desmontado**
 **Paso orificios patas 25 mm**



ART.	A mm	P mm	H mm	RAL	
WORK2007	2000	750	732/1107	7035+7016	
WORK2008	2000	750	732/1107	5012	

Compuesto por:

cant.	descripción
1	Banco desmontado regulable con encimera de multiplex 30 mm
1	Armario A=500 mm con 4 cajones H=105 mm
1	Armario A=500 mm con 1 puerta y 1 estante regulable
1	Cierre trasero
1	Medio estante no ranurado A=760 mm
1	Fondo de cierre para armario A=500 mm



ART.	A mm	P mm	H mm	RAL	
WORK2011	2000	750	732/1107	7035+7016	
WORK2012	2000	750	732/1107	5012	

Compuesto por:

cant.	descripción
1	Banco desmontado regulable con encimera de multiplex 30 mm
1	Armario A=500 mm con 1 cajón H=150 mm y 1 puerta
2	Armario A=629 mm con 1 cajón H=150 mm y 1 puerta
1	Medio estante no ranurado A=1760 mm



ART.	A mm	P mm	H mm	RAL	
WORK2009	2000	750	732/1107	7035+7016	
WORK2010	2000	750	732/1107	5012	

Compuesto por:

cant.	descripción
1	Banco desmontado regulable con encimera de multiplex 30 mm
1	Armario A=500 mm con 4 cajones H=105 mm
2	Armario A=629 mm con 1 puerta y 1 estante regulable
1	Medio estante no ranurado A=1760 mm

WORK UP 2000

Ejemplos de configuración

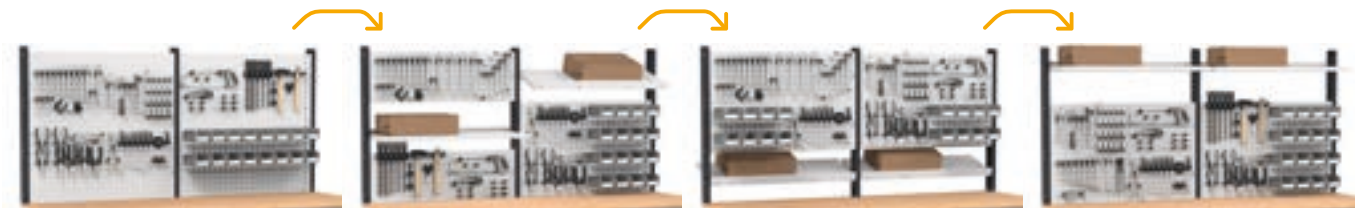

Herramientas excluidas



Herramientas excluidas



Herramientas excluidas



ART.	A mm	P mm	H mm	RAL
WORK2033	2000	750	1675/2050	7035+7016
WORK2039	2000	750	1675/2050	5012

Compuesto por:

cant.	descripción
1	Banco desmontado regulable con encimera de multiplex 30 mm
1	Cierre trasero
1	Armario A=500 mm con 1 puerta y 1 estante regulable
1	Fondo de cierre para armario A=500 mm
1	Armario A=500 mm con 4 cajones H=105 mm
1	Medio estante no ranurado A=760 mm
1	Kit 3 montantes con dos aletas
2	Kit de 3 paneles perforados/repisas con 2 bordes bloquea caja
6	Gancho Unipok para herramientas - paquete de 30 unidades
4	Barra gancho con 4 contenedores Picking Box tamaño 1

ART.	A mm	P mm	H mm	RAL
WORK2034	2000	750	1675/2050	7035+7016
WORK2040	2000	750	1675/2050	5012

Compuesto por:

cant.	descripción
1	Banco desmontado regulable con encimera de multiplex 30 mm
2	Armario A=629 mm con 1 cajón H=150 mm y 1 puerta
1	Armario A=500 mm con 1 cajón H=150 mm y 1 puerta
1	Medio estante no ranurado A=1760 mm
1	Kit 3 montantes con dos aletas
2	Kit de 3 paneles perforados/repisas con 2 bordes bloquea caja
6	Gancho Unipok para herramientas - paquete de 30 unidades
4	Barra gancho con 4 contenedores Picking Box tamaño 1







ART.	A mm	P mm	H mm	RAL
WORK2035	2000	750	1675/2050	7035+7016
WORK2041	2000	750	1675/2050	5012

Compuesto por:

cant.	descripción
1	Banco desmontado regulable con encimera de multiplex 30 mm
2	Armario A=629 mm con 1 puerta y 1 estante regulable
1	Armario A=500 mm con 4 cajones H=105 mm
1	Medio estante no ranurado A=1760 mm
1	Kit 3 montantes con dos aletas
2	Kit de 3 paneles perforados/repisas con 2 bordes bloquea caja
6	Gancho Unipok para herramientas - paquete de 30 unidades
4	Barra gancho con 4 contenedores Picking Box tamaño 1



 RAL 7035 RAL 7035 + RAL 7016

-  **1000 kg**
-  **altura regulable**
-  **Se suministra desmontado**
-  **Paso orificios patas 25 mm**
-  **Encimera de multiplex espesor 30 mm**
-  **encimera de acero espesor 3 mm**

Banco Work Up con encimera de acero



ART.	A mm	P mm	H mm	encimera		RAL	
				material	mm		
FBG01S1000R00PD	1031	704	737/1112	Acero	3	7035+7016	
FBG01S1000R0004	1031	704	737/1112	Acero	3	5012	
FBG01S1500R00PD	1507	704	737/1112	Acero	3	7035+7016	
FBG01S1500R0004	1507	704	737/1112	Acero	3	5012	
FBG01S2000R00PD	2007	704	737/1112	Acero	3	7035+7016	
FBG01S2000R0004	2007	704	737/1112	Acero	3	5012	

Banco Work Up con encimera de madera



ART.	A mm	P mm	H mm	encimera		RAL	
				material	mm		
FBG02S1000R00PD	1024	750	732/1107	Multiplex	30	7035+7016	
FBG02S1000R0004	1024	750	732/1107	Multiplex	30	5012	
FBG02S1500R00PD	1500	750	732/1107	Multiplex	30	7035+7016	
FBG02S1500R0004	1500	750	732/1107	Multiplex	30	5012	
FBG02S2000R00PD	2000	750	732/1107	Multiplex	30	7035+7016	
FBG02S2000R0004	2000	750	732/1107	Multiplex	30	5012	



Embalaje banco desmontado

Kit de ruedas

Aptas solo para bancos Work Up



ART.	Ø mm	KG	H mm	material			
FKRU1252101	125	300	155	Goma antihuella sintética	2	2	
FKRS1252101	125	750	155	Goma elástica	2	2	



RUEDA GIRATORIA CON FRENO



RUEDA FIJA

Par de escuadras de refuerzo



ART.	A mm	P mm	H mm	RAL	
FBGKITS0008	145	39	145	7035	
FBGKITS0004	145	39	145	5012	



Utilizar un par de escuadras por cada pata si no hay una cajonera

 1000 kg

 Encimera de multiplex espesor 30 mm

 Se suministra desmontado

 encimera de acero espesor 3 mm



Banco Work con encimera de acero

ART.	A mm	P mm	H mm	encimera		RAL	
				material	 mm		
FBG01S1000F00PD	1031	704	887	Acero	3	7035+7016	
FBG01S1000F0004	1031	704	887	Acero	3	5012	
FBG01S1500F00PD	1507	704	887	Acero	3	7035+7016	
FBG01S1500F0004	1507	704	887	Acero	3	5012	
FBG01S2000F00PD	2007	704	887	Acero	3	7035+7016	
FBG01S2000F0004	2007	704	887	Acero	3	5012	

Banco Work con encimera de madera

ART.	A mm	P mm	H mm	encimera		RAL	
				material	 mm		
FBG02S1000F0008	1024	750	882	Multiplex	30	7035	
FBG02S1000F0004	1024	750	882	Multiplex	30	5012	
FBG02S1500F0008	1500	750	882	Multiplex	30	7035	
FBG02S1500F0004	1500	750	882	Multiplex	30	5012	
FBG02S2000F0008	2000	750	882	Multiplex	30	7035	
FBG02S2000F0004	2000	750	882	Multiplex	30	5012	



Embalaje banco desmontado

Cobertura para encimera de acero

ART.	A mm	P mm	H mm	color	
FBG32100007	1024	702	27	Negro	
FBG32150007	1500	702	27	Negro	
FBG32200007	2000	702	27	Negro	



Cobertura para encimera de multiplex

ART.	A mm	P mm	H mm	color	
FBL22300007	1028	754	22	Negro	
FBL22600007	1504	754	22	Negro	
FBL22900007	2004	754	22	Negro	
FBL23200007	3004	754	22	Negro	



 RAL 5012

 RAL 7035

 RAL 7035 + RAL 7016

 ESPESOR

 CAPACIDAD

1000



1500



2000



Armarios con cajones

A → 500 mm

Armario con 1 cajón



ART.	A mm	P mm	H mm	cajones				puerta		RAL
				n.º	KG		h mm	n.º	Hentrada mm	
FBG03S50C0001PD	500	630	210	1	80	86%	150	-	-	7035+7016
FBG03S50C000104	500	630	210	1	80	86%	150	-	-	5012

Armario con 3 cajones



ART.	A mm	P mm	H mm	cajones				puerta		RAL
				n.º	KG		h mm	n.º	Hentrada mm	
FBG03S50C0002PD	500	630	570	3	80	86%	150	-	-	7035+7016
FBG03S50C000204	500	630	570	3	80	86%	150	-	-	5012

Armario con 4 cajones



ART.	A mm	P mm	H mm	cajones				puerta		RAL
				n.º	KG		h mm	n.º	Hentrada mm	
FBG03S50C0003PD	500	630	570	4	80	86%	105	-	-	7035+7016
FBG03S50C000304	500	630	570	4	80	86%	105	-	-	5012

Armario con 1 cajón y 1 puerta



ART.	A mm	P mm	H mm	cajones				puerta		RAL
				n.º	KG		h mm	n.º	Hentrada mm	
FBG03S50C0004PD	500	630	570	1	80	86%	150	1	310	7035+7016
FBG03S50C000404	500	630	570	1	80	86%	150	1	310	5012

⚠ Sin fondo de cierre

Armario con 1 puerta y 1 estante



ART.	A mm	P mm	H mm	cajones				puerta		RAL
				n.º	KG		h mm	n.º	Hentrada mm	
FBG03S50C0005PD	500	612	570	-	-	-%	-	1	491	7035+7016
FBG03S50C000504	500	612	570	-	-	-%	-	1	491	5012

⚠ Sin fondo de cierre

Fondo de cierre

Fondo de cierre para armarios A= 500 mm

ART.	A mm	P mm	H mm	RAL
FBG16S50V0V0008	494	572	4	7035
FBG16S50V0V0004	494	572	4	5012

⚠ Para utilizar en los armarios con puerta cuando hay un medio estante

Fondo de cierre para armarios A= 629 mm

ART.	A mm	P mm	H mm	RAL
FBG16S63V0V0008	623	572	4	7035
FBG16S63V0V0004	623	572	4	5012

⚠ Para utilizar en los armarios con puerta cuando hay un medio estante



Armarios con cajones

A → 629 mm

Armario con 3 cajones

ART.	A mm	P mm	H mm	cajones				puerta		RAL
				n.º	KG	EXTR	h mm	n.º	Hentrada mm	
FBG03S63C0002PD	629	630	570	3	80	86%	150	-	-	7035+7016
FBG03S63C000204	629	630	570	3	80	86%	150	-	-	5012

Armario con 4 cajones

ART.	A mm	P mm	H mm	cajones				puerta		RAL
				n.º	KG	EXTR	h mm	n.º	Hentrada mm	
FBG03S63C0003PD	629	630	570	4	80	86%	105	-	-	7035+7016
FBG03S63C000304	629	630	570	4	80	86%	105	-	-	5012

Armario con 1 cajón y 1 puerta

ART.	A mm	P mm	H mm	cajones				puerta		RAL
				n.º	KG	EXTR	h mm	n.º	Hentrada mm	
FBG03S63C0004PD	629	630	570	1	80	86%	150	1	310	7035+7016
FBG03S63C000404	629	630	570	1	80	86%	150	1	310	5012

⚠ Sin fondo de cierre

Armario con 1 puerta y 1 estante

ART.	A mm	P mm	H mm	cajones				puerta		RAL
				n.º	KG	EXTR	h mm	n.º	Hentrada mm	
FBG03S63C0005PD	629	612	570	-	-	-%	-	1	491	7035+7016
FBG03S63C000504	629	612	570	-	-	-%	-	1	491	5012

⚠ Sin fondo de cierre

RAL 5012
 RAL 7035
 RAL 7035 + RAL 7016
 CAPACIDAD
 EXTRACCIÓN

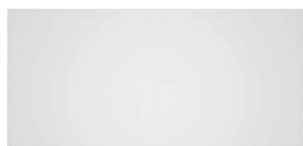

Cierre trasero

ART.	A mm	H mm	apto para banco Anch. mm	RAL	
FBG12S080000008	825	665	1024-1031	7035	
FBG12S080000004	825	665	1024-1031	5012	
FBG12S130000008	1325	665	1500-1507	7035	
FBG12S130000004	1325	665	1500-1507	5012	
FBG12S180000008	1825	665	2000-2007	7035	
FBG12S180000004	1825	665	2000-2007	5012	



Par de tampones laterales

Para banco A=1024-1031 mm con armario A=629 mm

ART.	A mm	P mm	H mm	RAL	
FBG14S130V00008	65	35	568	7035	
FBG14S130V00004	65	35	568	5012	



Panel perforado lateral

ART.	A mm	P mm	H mm	Medida del orificio (mm)	RAL	
FBG15S00V0V0008	610	75	669	10x10	7035	
FBG15S00V0V0004	610	75	669	10x10	5012	

Estante no ranurado adicional

ART.	A mm	P mm	H mm	KG	RAL	
FBG08S070600108	760	600	35	250	7035	
FBG08S070600104	760	600	35	250	5012	
FBG08S120600108	1260	600	35	250	7035	
FBG08S120600104	1260	600	35	250	5012	
FBG08S170600108	1760	600	35	200	7035	
FBG08S170600104	1760	600	35	200	5012	





Medio estante no ranurado adicional

ART.	A mm	P mm	H mm	KG	RAL	
FBG09S070300108	760	300	35	100	7035	
FBG09S070300104	760	300	35	100	5012	
FBG09S120300108	1260	300	35	100	7035	
FBG09S120300104	1260	300	35	100	5012	
FBG09S170300108	1760	300	35	100	7035	
FBG09S170300104	1760	300	35	100	5012	



Soporte sólo para medio estante adicional

ART.	A mm	P mm	H mm	RAL	
FBG13S605V00008	605	77	35	7035	
FBG13S605V00004	605	77	35	5012	



ART.	A mm	P mm	H mm	KG	RAL	
WORK2014	2007	704	737/1112	1000	7035+7016	

Compuesto por:

cant.	descripción
1	Banco desmontado regulable con encimera de acero 3 mm
1	Armario A=500 mm con 4 cajones H=105 mm
1	Armario A=500 mm con 1 puerta y 1 estante regulable
1	Cierre trasero
1	Medio estante no ranurado A=760 mm
1	Fondo de cierre para armario A=500 mm
2	Panel perforado lateral



RAL 7035



RAL 5012



RAL 7035 + RAL 7016



CAPACIDAD

A= 500 MM 27X27 EH



ART.	apto para cajón H mm	N. divisores transversales	
FBG18S50DV00199	105/150	3	

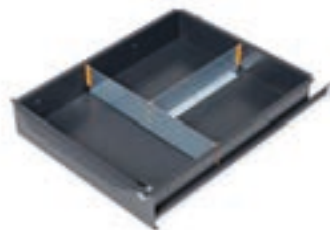

ART.	apto para cajón H mm	N. divisores transversales	N. divisores longitudinales	
FBG18S50DV00299	105/150	1	1	



ART.	apto para cajón H mm	componentes	
FBG18S50CD00103	105/150	4 x Caja divisor 100x50 mm	



ART.	apto para cajón H mm	componentes	
FBG18S50CD00203	105/150	3 x Caja divisor 100x50 mm 2 x Caja divisor 150x75 mm 1 x Caja divisor 150x150 mm	



ART.	apto para cajón H mm	componentes	
MATSEP001	105/150	1 x FBG18S50CD00103 1 x FBG18S50CD00203 1 x FBG18S50DV00299	



ART.	apto para cajón H mm	componentes	
MATSEP002	105/150	1 x FBG18S50CD00103 2 x FBG18S50CD00203 1 x FBG18S50DV00299	



Cinta para cajonera L=500 mm

ART.	material	
FBG18S50TP00107	Poliéster	

WORK-WORK UP

MATERIAL DE SEPARACIÓN

A= 629 MM 36X27 EH

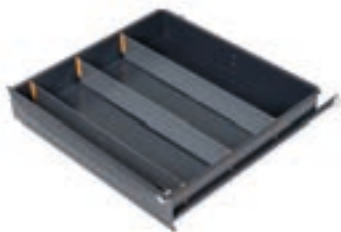

ART.	apto para cajón H mm	N. divisores transversales	
FBG18S63DV00199	105/150	3	



ART.	apto para cajón H mm	N. divisores transversales	N. divisores longitudinales	
FBG18S63DV00299	105/150	1	1	



ART.	apto para cajón H mm	componentes	
FBG18S63CD00103	105/150	5 x Caja divisor 100x50 mm	



ART.	apto para cajón H mm	componentes	
FBG18S63CD00203	105/150	2 x Caja divisor 75x75 mm 2 x Caja divisor 150x75 mm 2 x Caja divisor 150x150 mm	



ART.	apto para cajón H mm	componentes	
MATSEP003	105/150	1 x FBG18S63CD00103 1 x FBG18S63CD00203 1 x FBG18S63DV00299	



ART.	apto para cajón H mm	componentes	
MATSEP004	105/150	1 x FBG18S63CD00103 2 x FBG18S63CD00203 1 x FBG18S63DV00299	



Cinta para cajonera L=629 mm

ART.	material	
FBG18S63TP00107	Poliéster	

Configuraciones alternativas



Herramientas excluidas



ART.	A mm	P mm	H mm	KG	RAL
WORK2042	2260	704	2098	1000	7035+7016

Compuesto por:

cant.	descripción
1	Banco desmontado con encimera de acero de 3 mm
2	Armario A=629 mm con 1 cajón H=150 mm y 1 puerta
1	Armario A=500 mm con 1 cajón H=150 mm y 1 puerta
2	Panel perforado lateral
1	Canasta de 30 l de capacidad
1	Kit 3 montantes con dos aletas
1	Kit de 3 soportes inclinados con 2 guías
2	Kit de 3 paneles perforados/repisas con 2 bordes bloquea caja
1	Lámpara doble

cant.	descripción
7	Gancho Unipok para herramientas - paquete de 30 unidades
1	Kit porta rollo con papel Ø=240 mm
2	Porta bombonas inclinado de 2 puestos
1	Repisa grande reversible
1	Soporte toma múltiple de 4 compartimentos
1	Toma múltiple Schuko de 4 compartimentos
1	Cable de conexión Wieland Schuko/FR
2	Barra gancho con 4 contenedores Picking Box tamaño 1

Configuraciones alternativas



Herramientas excluidas



ART.	A mm	P mm	H mm	KG	RAL
WORK1540	2052	750	1977/2352	1000	7035+7016

Compuesto por:

cant.	descripción
1	Banco desmontado regulable con encimera de multiplex 30 mm
1	Armario A=629 mm con 1 puerta y 1 estante regulable
1	Fondo de cierre para armario A=629 mm
1	Armario A=629 mm con 3 cajones H=150 mm
2	Panel perforado lateral
1	Canasta de 30 l de capacidad
1	Repisa grande reversible
2	Porta bombonas inclinado de 2 puestos
1	Kit de 2 montantes con dos aletas para bancos
1	Kit de 2 soportes inclinados con guía

cant.	descripción
1	Kit de 3 paneles perforados/repisas con 2 bordes bloquea caja
1	Lámpara doble
1	Lámpara simple
1	Kit porta rollo con papel Ø 130 mm
1	Soporte toma múltiple de 4 compartimentos
1	Toma múltiple Schuko de 4 compartimentos
1	Cable de conexión Wieland Schuko/FR
4	Gancho Unipok para herramientas - paquete de 30 unidades
2	Barra gancho con 4 contenedores Picking Box tamaño 1



RAL 7035 + RAL 7016



CAPACIDAD

DYNAMIC

BANCOS DE TRABAJO

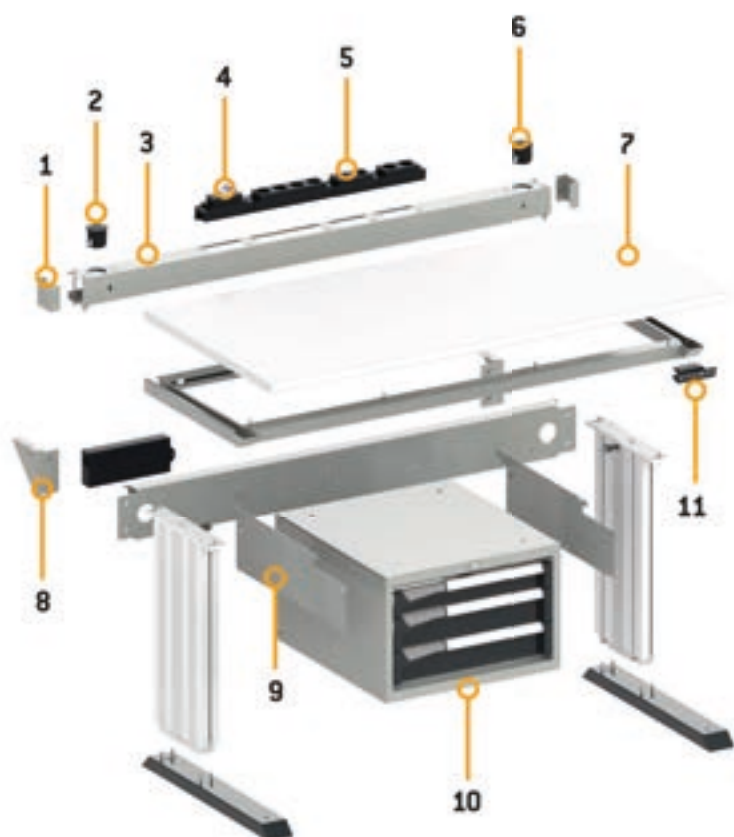

- | | |
|--------------------|-------------------------|
| 1. Tampón | 7. Encimera de laminado |
| 2. USB datos | 8. Angular |
| 3. Bastidor | 9. Soporte |
| 4. Magnetotérmico | 10. Armario con cajones |
| 5. Tomas múltiples | 11. Teclado |
| 6. USB recarga | |



**Capacidad banco
400 kg**

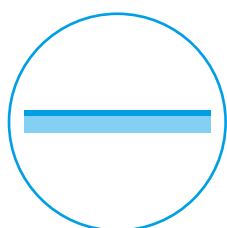

Encimera de laminado

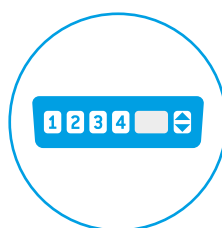

**Teclado con 3
memorias**

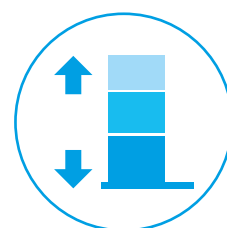

**Altura regulable
electrónicamente**

DYNAMIC



ART.	A mm	P mm	H mm	KG	RAL
DYNAMIC1504	1497	780	740/1140	400	7035+7016

Compuesto por:

cant.	descripción	cant.	descripción
1	Banco desmontado regulable eléctricamente	1	Toma múltiple Schuko de 4 compartimentos
1	Armario A=560 mm con 3 cajones 1x75 2x100	1	Magnetotérmico diferencial
1	Bastidor para tomas adicional con tampones y angulares	1	Cable de conexión Wieland con clavijas in/out
1	Par de soportes para armario	1	Cable de conexión Wieland Schuko/FR
2	Toma múltiple Schuko de 2 compartimentos	1	Toma USB de datos
		1	Toma USB de recarga



RAL 7035 + RAL 7016



CAPACIDAD



ART.	A mm	P mm	H mm	KG	RAL
DYNAMIC1501	1497	780	1983/2383	400	7035+7016

Compuesto por:

cant.	descripción	cant.	descripción
1	Banco desmontado regulable eléctricamente	2	Lámpara simple
1	Armario A=560 mm con 3 cajones 1x75 2x100	1	Guía suplementaria con fijaciones
2	Panel perforado/repisa con borde bloquea caja	1	Toma USB de recarga
1	Kit de 2 montantes con dos aletas para bancos	1	Toma USB de datos
1	Kit de 2 soportes inclinados con guía	1	Cable de conexión Wieland Schuko/FR
1	Panel perforado electric	1	Magnetotérmico diferencial
1	Lámpara doble	1	Toma múltiple Schuko de 4 compartimentos
1	Par de soportes para armario	2	Toma múltiple Schuko de 2 compartimentos
1	Bastidor para tomas adicional con tampones y angulares	36	Contenedor de polipropileno Picking Box tamaño 2

DYNAMIC



ART.	A mm	P mm	H mm	KG	RAL
DYNAMIC1503	1497	780	1983/2383	400	7035+7016

Compuesto por:

cant.	descripción
1	Banco desmontado regulable eléctricamente
1	Armario A=500 mm con 1 cajón H=150 mm
1	Guía suplementaria con fijaciones
1	Panel perforado/repisa
2	Panel perforado/repisa con borde bloquea caja
1	Kit de 2 montantes con dos aletas para bancos
1	Kit de 2 soportes inclinados con guía
1	Repisa porta objetos reversible
1	Gancho Unipok para herramientas - paquete de 30 unidades
1	Tapa para armario A=500 mm
2	Toma múltiple Schuko de 2 compartimentos
1	Toma múltiple Schuko de 4 compartimentos
1	Magnetotérmico diferencial
1	Cable de conexión Wieland Schuko/FR
1	Toma USB de datos
1	Toma USB de recarga
1	Panel perforado electric
1	Lámpara doble
3	Lámpara simple
1	Bastidor para tomas adicional con tampones y angulares
1	Par de soportes para armario
36	Contenedor de polipropileno Picking Box tamaño 2



ART.	A mm	P mm	H mm	KG	RAL
DYNAMIC1502	1497	780	1983/2383	400	7035+7016

Compuesto por:

cant.	descripción
1	Banco desmontado regulable eléctricamente
2	Armario colgante con puerta
1	Guía suplementaria con fijaciones
2	Panel perforado/repisa con borde bloquea caja
1	Kit de 2 montantes con dos aletas para bancos
1	Kit de 2 soportes inclinados con guía
1	Panel perforado electric
1	Toma múltiple Schuko de 4 compartimentos
1	Magnetotérmico diferencial
1	Cable de conexión Wieland Schuko/FR
1	Toma USB de datos
1	Toma USB de recarga
1	Repisa porta objetos reversible
1	Lámpara doble
1	Lámpara simple
1	Bastidor para tomas adicional con tampones y angulares
2	Toma múltiple Schuko de 2 compartimentos
18	Contenedor de polipropileno Picking Box tamaño 2



RAL 7035 + RAL 7016



CAPACIDAD

 400 kg

 altura regulable

 Se suministra desmontado



Banco básico con travesaño reversible

ART.	A mm	P mm	H mm	RAL
FLE0970E0PD	985	700	740/1140	7035+7016
FLE1470E0PD	1470	700	740/1140	7035+7016

1. Travesaño reversible



El banco está equipado con patas de altura regulable electrónicamente. La altura puede variar entre un mínimo de 740 mm y un máximo de 1140 mm.



El teclado numérico permite controlar el mecanismo de regulación del banco. Además de permitir la modificación de la altura de la encimera, dispone de 3 memorias de posicionamiento para cambiar rápidamente la altura del banco en función del usuario.

vista frontal del travesaño



vista trasera del travesaño



El travesaño del banco tiene incisiones para la colocación de las tomas eléctricas y de los interruptores magnetotérmicos Iron Team Electric. Dependiendo del tamaño elegido, el número de ranuras varía. Los diferentes componentes pueden instalarse tanto en la parte trasera como en la parte delantera del travesaño.

Los Iron Team Electric no se incluyen con el travesaño.

Esquema de tomas del travesaño

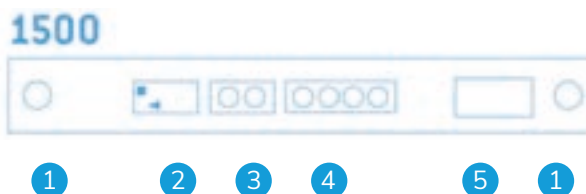
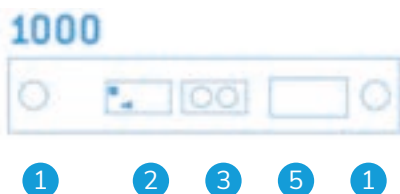

- 1** orificio para cables
- 2** magnetotérmico
- 3** toma múltiple de 2 compartimentos
- 4** toma múltiple de 4 compartimentos
- 5** centralita



1. Travesaño reversible
2. Bastidor
3. Angulares
4. Tampones

Bastidor para tomas adicional con tampones y angulares

ART.	A mm	P mm	H mm	RAL	
FBL46600008	1014	130	208	7035	
FBL46650008	1499	130	208	7035	

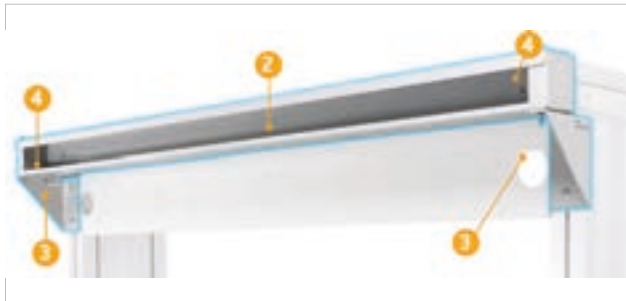

vista superior del bastidor



vista inferior del bastidor



Para el montaje del montante Work Look se requiere la instalación del bastidor adicional.

El bastidor reversible tiene incisiones para la colocación de las tomas eléctricas y de los interruptores magnetotérmicos Iron Team Electric. Dependiendo del tamaño elegido, el número de ranuras varía. Los diferentes componentes pueden instalarse tanto en la parte superior como en la parte inferior del bastidor reversible.

Los Iron Team Electric no se incluyen con el bastidor reversible.

esquema de tomas del bastidor



- 1
- 2
- 4
- 3
- 3
- 5

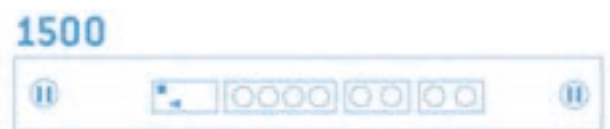

- 1
- 2
- 4
- 3
- 3
- 5

- 1 USB datos
- 2 magnetotérmico
- 3 toma múltiple de 2 compartimentos
- 4 toma múltiple de 4 compartimentos
- 5 USB recarga



Armario con 3 cajones



ART.	A mm	P mm	H mm	cajones					RAL		
				n.º	h 75 mm	h 100 mm	KG				
MBR05SC010203PD	560	610	369	3	1	2	100-75-50		92-96-100%	7035+7016	

Armario con 1 cajón



ART.	A mm	P mm	H mm	cajones				RAL		
				n.º	KG		h mm			
FBG03S50C0001PD	500	630	210	1	80	86%	150		7035+7016	



Tapa para armario A=500 mm

Para armario con 1 cajón

ART.	A mm	P mm	H mm	RAL	
FBL66900008	496	601	2	7035	



Par de soportes para armario

ART.	A mm	P mm	H mm	RAL	
FBL46010008	2	648	181	7035	

IRONTEAM Electric



FBLET012007



FBLET004007



FBLET005007



FBLET016007



FBLET013007



FBLET020007



FBLET019007

ver página 96



El banco de altura regulable electrónicamente Dynamic permite crear una estación de trabajo dinámica y ergonómica apta para su uso en numerosos sectores. Para maximizar la comodidad del usuario, Dynamic ofrece numerosas soluciones: armarios con cajones, marcos adicionales o travesaños para componentes eléctricos, paredes perforadas Work Look. Las patas de altura regulable se controlan mediante un práctico teclado. La altura del banco puede regularse al milímetro entre un mínimo de 740 mm y un máximo de 1140 mm. Permite memorizar tres alturas diferentes para regular la encimera de forma rápida y sencilla en pocos movimientos.



1. Alfombrilla ESD de 2 capas
2. Clavija schuko ESD
3. Correa ajustable con botón completo con cable
4. Cable con botón

Alfombrilla ESD de 2 capas

ART.	A mm	P mm	H mm
FAXTAPPIER120XB	900	600	2

Clavija schuko ESD

ART.	A mm	P mm	H mm
FAXSCHUKOESD005	52	52	72

Correa ajustable con botón completo con cable

ART.	Longitud del cable (m)
FAXITE780419304	2,5

Cable con botón

ART.	A mm
FAXITE7804885XB	2500

WORK LOOK

TABIQUES EQUIPADOS

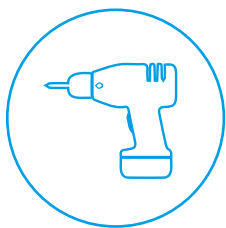
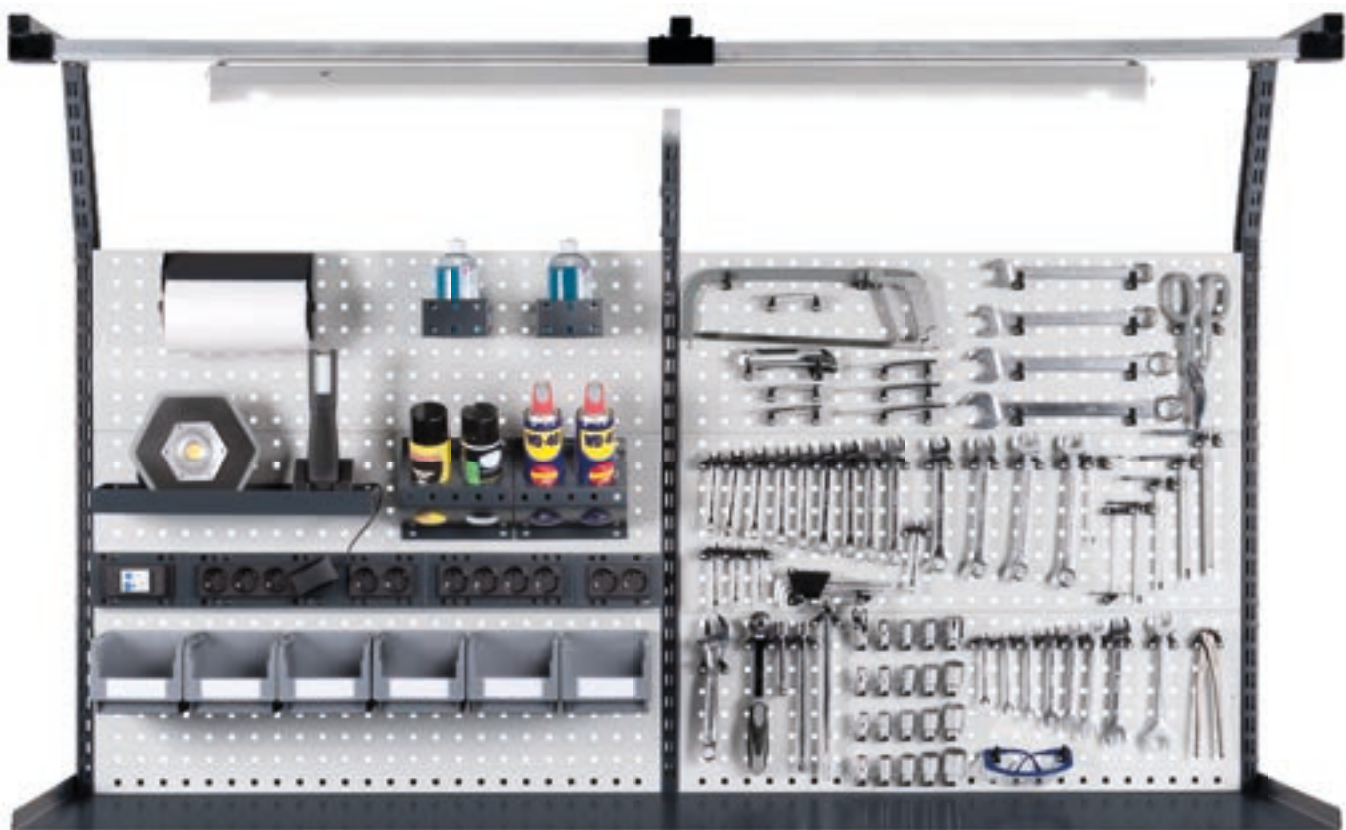

Fijación a la pared

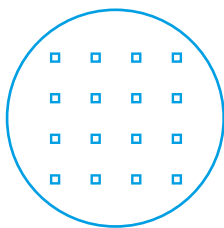

Orificios cuadrados de 10x10

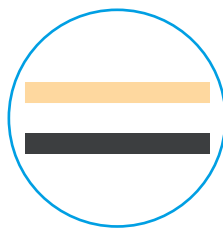

Aptos para encimeras de madera y acero

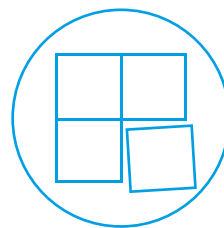

Modulares

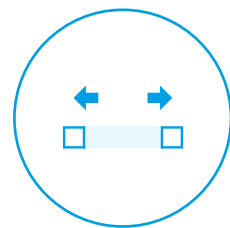

Paso 38 mm

WORK LOOK



ART.	A mm	P mm	H mm	KG	RAL
MASTERBR1507	1706	750	1985/2360	1000	7035+7016

Compuesto por:

cant.	descripción
1	Banco desmontado con encimera de multiplex de 40 mm
1	Armario A=560 mm con 5 cajones 1x75 3x100 1x200
2	Estante superior/inferior A=560 mm
1	Puerta total izquierda H=600 mm con asa Dark Grey
1	Estante interno A=558 mm
1	Soporte para medio estante intermedio
2	Panel perforado lateral
1	Barra de leds
1	Par de soportes de fijación de unidad de pared a los montantes
1	Unidad de pared de apertura basculante sin cerradura
1	Lámpara doble
1	Kit 2 paneles perforados/repisas con 1 borde bloquea caja
1	Kit de 2 soportes inclinados con guía

cant.	descripción
1	Kit de 2 montantes con dos aletas para bancos
1	Canasta de 30 l de capacidad
1	Repisa grande reversible
1	Barra gancho con 4 contenedores Picking Box tamaño 1
3	Gancho Unipok para herramientas - paquete de 30 unidades
2	Porta bombonas inclinado de 2 puestos
1	Kit porta rollo con papel Ø 130 mm
1	Bolsillo porta documentos A4
1	Cable de conexión Wieland Schuko/FR
1	Toma múltiple Schuko de 4 compartimentos
1	Toma múltiple Schuko de 2 compartimentos
1	Soporte toma múltiple de 4 compartimentos
1	Soporte toma múltiple de 2 compartimentos
1	Kit de 2 contenedores Picking Box tamaño 3A2



CAPACIDAD



RAL 7035+RAL 7016

WORK LOOK



Cambia el aspecto de tu banco de trabajo para adaptarlo a diferentes usos con Work Look

De acuerdo con la manera de instalarlo, podrás utilizarlo como:

panel perforado, repisa horizontal, repisa inclinada con borde bloquea caja.

ART.	A mm	P mm	H mm	KG montantes	RAL
WORKLOOK1001	1015	80	639	50	7035+7016
WORKLOOK1002	1015	80	639	50	5012

Compuesto por:

cant.	descripción
1	Kit de 2 montantes con dos aletas para bancos
1	Kit 2 paneles perforados/repisas con 1 borde bloquea caja

ART.	A mm	P mm	H mm	KG montantes	RAL
WORKLOOK1003	1015	80	943	50	7035+7016
WORKLOOK1004	1015	80	943	50	5012

Compuesto por:

cant.	descripción
1	Kit de 2 montantes con dos aletas para bancos
1	Kit de 3 paneles perforados/repisas con 2 bordes bloquea caja

ART.	A mm	P mm	H mm	KG montantes	RAL
WORKLOOK1501	1500	80	639	50	7035+7016
WORKLOOK1502	1500	80	639	50	5012

Compuesto por:

cant.	descripción
1	Kit de 2 montantes con dos aletas para bancos
1	Kit 2 paneles perforados/repisas con 1 borde bloquea caja

ART.	A mm	P mm	H mm	KG montantes	RAL
WORKLOOK1503	1500	80	943	50	7035+7016
WORKLOOK1504	1500	80	943	50	5012

Compuesto por:

cant.	descripción
1	Kit de 2 montantes con dos aletas para bancos
1	Kit de 3 paneles perforados/repisas con 2 bordes bloquea caja

WORK LOOK



ART.	A mm	P mm	H mm	KG montantes	RAL
WORKLOOK2001	2000	80	639	50	7035+7016
WORKLOOK2002	2000	80	639	50	5012

Compuesto por:

cant.	descripción
1	Kit 3 montantes con dos aletas
2	Kit 2 paneles perforados/repisas con 1 borde bloquea caja



ART.	A mm	P mm	H mm	KG montantes	RAL
WORKLOOK2003	2000	80	943	50	7035+7016
WORKLOOK2004	2000	80	943	50	5012

Compuesto por:

cant.	descripción
1	Kit 3 montantes con dos aletas
2	Kit de 3 paneles perforados/repisas con 2 bordes bloquea caja



ART.	A mm	P mm	H mm	KG montantes	RAL
WORKLOOK3001	2970	80	639	50	7035+7016
WORKLOOK3002	2970	80	639	50	5012

Compuesto por:

cant.	descripción
1	Kit 3 montantes con dos aletas
2	Kit 2 paneles perforados/repisas con 1 borde bloquea caja



ART.	A mm	P mm	H mm	KG montantes	RAL
WORKLOOK3003	2970	80	943	50	7035+7016
WORKLOOK3004	2970	80	943	50	5012

Compuesto por:

cant.	descripción
1	Kit 3 montantes con dos aletas
2	Kit de 3 paneles perforados/repisas con 2 bordes bloquea caja

Ejemplos de configuración



CAPACIDAD



RAL 7035 + RAL 7016



RAL 5012

WORKLOOK



ART.	A mm	P mm	H mm	KG montantes	RAL	
WORKLOOK1005	1015	373	1063	50	7035+7016	
WORKLOOK1006	1015	373	1063	50	5012	

Compuesto por:

cant.	descripción
1	Kit de 2 montantes con dos aletas para bancos
1	Kit 2 paneles perforados/repisas con 1 borde bloquea caja
1	Unidad de pared de apertura basculante sin cerradura
1	Par de soportes de fijación de unidad de pared a los montantes



ART.	A mm	P mm	H mm	KG montantes	RAL	
WORKLOOK1007	1015	373	1063	50	7035+7016	
WORKLOOK1008	1015	373	1063	50	5012	

Compuesto por:

cant.	descripción
1	Kit de 2 montantes con dos aletas para bancos
1	Panel perforado/repisa con borde bloquea caja
1	Panel perforado electric
1	Unidad de pared de apertura basculante sin cerradura
1	Par de soportes de fijación de unidad de pared a los montantes
1	Toma múltiple Schuko de 4 compartimentos
1	Cable de conexión Wieland Schuko/FR



ART.	A mm	P mm	H mm	KG montantes	RAL	
WORKLOOK1505	1500	373	1063	50	7035+7016	
WORKLOOK1506	1500	373	1063	50	5012	

Compuesto por:

cant.	descripción
1	Kit de 2 montantes con dos aletas para bancos
1	Kit 2 paneles perforados/repisas con 1 borde bloquea caja
1	Unidad de pared de apertura basculante sin cerradura
1	Par de soportes de fijación de unidad de pared a los montantes



ART.	A mm	P mm	H mm	KG montantes	RAL	
WORKLOOK1507	1500	373	1063	50	7035+7016	
WORKLOOK1508	1500	373	1063	50	5012	

Compuesto por:

cant.	descripción
1	Kit de 2 montantes con dos aletas para bancos
1	Panel perforado/repisa con borde bloquea caja
1	Panel perforado electric
1	Unidad de pared de apertura basculante sin cerradura
1	Par de soportes de fijación de unidad de pared a los montantes
1	Toma múltiple Schuko de 4 compartimentos
1	Cable de conexión Wieland Schuko/FR



WORK LOOK



ART.	A mm	P mm	H mm	KG montantes	RAL
WORKLOOK2005	2000	373	1063	50	7035+7016
WORKLOOK2006	2000	373	1063	50	5012

Compuesto por:

cant.	descripción
1	Kit 3 montantes con dos aletas
2	Kit 2 paneles perforados/repisas con 1 borde bloquea caja
2	Unidad de pared de apertura basculante sin cerradura
2	Par de soportes de fijación de unidad de pared a los montantes



ART.	A mm	P mm	H mm	KG montantes	RAL
WORKLOOK2007	2000	373	1063	50	7035+7016
WORKLOOK2008	2000	373	1063	50	5012

Compuesto por:

cant.	descripción
1	Kit 3 montantes con dos aletas
2	Panel perforado/repisa con borde bloquea caja
2	Panel perforado electric
2	Unidad de pared de apertura basculante sin cerradura
2	Par de soportes de fijación de unidad de pared a los montantes
2	Toma múltiple Schuko de 4 compartimentos
1	Cable de conexión Wieland con clavijas in/out
1	Cable de conexión Wieland Schuko/FR



ART.	A mm	P mm	H mm	KG montantes	RAL
WORKLOOK3005	2970	373	1063	50	7035+7016
WORKLOOK3006	2970	373	1063	50	5012

Compuesto por:

cant.	descripción
1	Kit 3 montantes con dos aletas
2	Kit 2 paneles perforados/repisas con 1 borde bloquea caja
2	Unidad de pared de apertura basculante sin cerradura
2	Par de soportes de fijación de unidad de pared a los montantes



ART.	A mm	P mm	H mm	KG montantes	RAL
WORKLOOK3007	2970	373	1063	50	7035+7016
WORKLOOK3008	2970	373	1063	50	5012

Compuesto por:

cant.	descripción
1	Kit 3 montantes con dos aletas
2	Panel perforado/repisa con borde bloquea caja
2	Panel perforado electric
2	Unidad de pared de apertura basculante sin cerradura
2	Par de soportes de fijación de unidad de pared a los montantes
2	Toma múltiple Schuko de 4 compartimentos
1	Cable de conexión Wieland con clavijas in/out
1	Cable de conexión Wieland Schuko/FR



Ejemplos de configuración



CAPACIDAD



RAL 7035 + RAL 7016



RAL 5012



Kit de 2 montantes con dos aletas para bancos

ART.	A mm	P mm	H mm	KG	apto para banco Anch. mm	RAL	
FBL75301604	30	80	639	50	1000-1500	5012	
FBL75301639	30	80	639	50	1000-1500	7016	
FBL75351604	30	80	943	50	1000-1500	5012	
FBL75351639	30	80	943	50	1000-1500	7016	

Kit 3 montantes con dos aletas

ART.	A mm	P mm	H mm	KG	apto para banco Anch. mm	RAL	
FBL75302104	30	80	639	50	2000-3000	5012	
FBL75302139	30	80	639	50	2000-3000	7016	
FBL75352104	30	80	943	50	2000-3000	5012	
FBL75352139	30	80	943	50	2000-3000	7016	

WORK LOOK

Soportes inclinados con guía base



Kit de 2 soportes inclinados con guía

ART.	A mm	P mm	H mm	RAL
FBL98102039	1015	686	307	7016
FBL98102004	1015	686	307	5012



Kit de 2 soportes inclinados con guía

ART.	A mm	P mm	H mm	RAL
FBL98152039	1500	686	307	7016
FBL98152004	1500	686	307	5012



Kit de 3 soportes inclinados con 2 guías

ART.	A mm	P mm	H mm	RAL
FBL98202039	2000	686	307	7016
FBL98202004	2000	686	307	5012



Kit de 3 soportes inclinados con 2 guías

ART.	A mm	P mm	H mm	RAL
FBL98302039	2970	686	307	7016
FBL98302004	2970	686	307	5012



Guía suplementaria con fijaciones

ART.	A mm	P mm	H mm	material
FBL98101000	1015	60	67	Aluminio
FBL98151000	1500	60	67	Aluminio



Set para aire comprimido con compensador y filtro

ART.
FBL97200300

Compuesto por:

- 1 cable flexible Ø 10 mm
- 1 conector en T de 1/4" con tapón (B)
- 2 conexiones correderas
- 1 mosquetón
- 1 compensador con cable de acero de 1600 mm de longitud, capacidad 1/2 kg
- 1 conexión universal 1/4" para herramientas (A)
- 1 tubo en espiral de 5,5 mm de diámetro interior
- 1 tubo de 5,5 mm de diámetro interior para la purga del filtro
- 1 grupo filtro regulador con manómetro — que se puede utilizar con una presión máxima de 10 bar, su capacidad es de aprox. 9 litros por segundo (en el punto A) y de 11 litros por segundo (en el punto B) con una presión de uso de 6,3 bar (la capacidad puede variar según las características técnicas de la red neumática a la cual esté conectado el equipo Fami)—
- Racores de 1/4"
- Racores de 1/4"



CAPACIDAD



RAL 7016



RAL 5012

WORK LOOK

Paneles perforados/repisa 953 mm



Panel perforado/repisa

ART.	A mm	P mm	H mm	Medida del orificio (mm)	Paso mm	RAL	
FBL76160008	953	40	304	10x10	38	7035	
FBL76160004	953	40	304	10x10	38	5012	



Kit 2 paneles perforados/repisas con 1 borde bloquea caja

ART.	A mm	P mm	H mm	Medida del orificio (mm)	Paso mm	RAL	
FBL76160208	953	60	304	10x10	38	7035	
FBL76160204	953	60	304	10x10	38	5012	



Kit de 3 paneles perforados/repisas con 2 bordes bloquea caja

ART.	A mm	P mm	H mm	Medida del orificio (mm)	Paso mm	RAL	
FBL76160308	953	60	304	10x10	38	7035	
FBL76160304	953	60	304	10x10	38	5012	

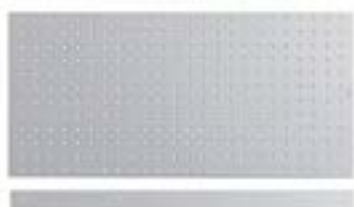

Panel perforado/repisa con borde bloquea caja

ART.	A mm	P mm	H mm	Medida del orificio (mm)	Paso mm	RAL	
FBL76170108	953	60	456	10x10	38	7035	
FBL76170104	953	60	456	10x10	38	5012	



Panel perforado electric

ART.	A mm	P mm	H mm	Medida del orificio (mm)	Paso mm	RAL	
FBL76180008	953	31	152	10x10	38	7035	
FBL76180004	953	31	152	10x10	38	5012	



1. USB datos
2. Magnetotérmico diferencial
3. Toma múltiple de 4 puestos
4. Toma múltiple de 2 puestos
5. USB recarga

WORK LOOK

Paneles perforados/repisa 1438 mm



Panel perforado/repisa

ART.	A mm	P mm	H mm	Medida del orificio (mm)	Paso mm	RAL	
FBL76310008	1438	40	304	10x10	38	7035	
FBL76310004	1438	40	304	10x10	38	5012	



Kit 2 paneles perforados/repisas con 1 borde bloquea caja

ART.	A mm	P mm	H mm	Medida del orificio (mm)	Paso mm	RAL	
FBL76310208	1438	60	304	10x10	38	7035	
FBL76310204	1438	60	304	10x10	38	5012	



Kit de 3 paneles perforados/repisas con 2 bordes bloquea caja

ART.	A mm	P mm	H mm	Medida del orificio (mm)	Paso mm	RAL	
FBL76310308	1438	60	304	10x10	38	7035	
FBL76310304	1438	60	304	10x10	38	5012	



Panel perforado/repisa con borde bloquea caja

ART.	A mm	P mm	H mm	Medida del orificio (mm)	Paso mm	RAL	
FBL76320108	1438	60	456	10x10	38	7035	
FBL76320104	1438	60	456	10x10	38	5012	



Panel perforado electric

ART.	A mm	P mm	H mm	Medida del orificio (mm)	Paso mm	RAL	
FBL76330008	1438	31	152	10x10	38	7035	
FBL76330004	1438	31	152	10x10	38	5012	



Par de soportes para panel perforado/estante

ART.	A mm	P mm	H mm	RAL	
FVT01010039	12	237	99	7016	



WORK LOOK



ART.	RAL	
WORKLOOK9001	7035	



Compuesto por:

cant.	descripción
2	Panel perforado/repisa con borde bloquea caja
3	Panel perforado/repisa
5	Kit de soportes para fijación de panel a pared
1	Repisa porta objetos reversible
1	Porta frasco higienizante reversible
1	Kit porta rollo con papel Ø=240 mm
1	Dispensador para guantes
1	Bolsillo porta documentos A4
2	Repisa grande reversible

cant.	descripción
1	Canasta de 30 l de capacidad
5	Gancho Unipok para herramientas - paquete de 30 unidades
1	Toma múltiple Schuko de 2 compartimentos
1	Toma múltiple Schuko de 4 compartimentos
1	Magnetotérmico diferencial
1	Cable de conexión Wieland Schuko/FR
1	Soporte toma múltiple de 2 compartimentos
1	Soporte toma múltiple de 4 compartimentos
1	Soporte para interruptor magnetotérmico diferencial
2	Lámpara doble

Kit de soportes para fijación de panel a pared

ART.	Acabado	
FBL76000099	Galvanizado	



WORK LOOK



Panel perforados consultar pág. 60/61
Fijación de pared de paneles perforados consultar pág. 62
Ganchos Unipok consultar pág. 85
Ganchos The Block consultar pág. 86
Accesorios Iron Team consultar pág. 90

RAL 7035

RAL 5012

WORK LOOK

Persianas



Armario con persiana

ART.	A mm	P mm	H mm	RAL	
FBL8050C00008	943	220	912	7035	
FBL8050C00004	943	220	912	5012	
FBL8054C00008	1428	220	912	7035	
FBL8054C00004	1428	220	912	5012	
FBL8056C00008	1928	220	912	7035	
FBL8056C00004	1928	220	912	5012	

Par de soportes de fijación de armario con persiana en los montantes

ART.	A mm	P mm	H mm	RAL	
FBL8060000008	33	21	904	7035	
FBL8060000004	33	21	904	5012	

⚠ Para fijar el armario con persiana a los montantes con dos orificios



Barra de leds

Sin tecla on/off

ART.	A mm	Temperatura color K	Watt	Hz	Lumen	
FBL99400213	873	4000	15	50/60	1500	
FBL99450213	1173	4000	20	50/60	2000	

WORK LOOK

Unidades de pared



Unidad de pared de apertura basculante sin cerradura

ART.	A mm	P mm	H mm	KG	RAL
FBL8005X000PD	943	350	456	50	7035+7016
FBL8005X00004	943	350	456	50	5012
FBL8010X000PD	1428	350	456	50	7035+7016
FBL8010X00004	1428	350	456	50	5012



Set de cierre para armario colgante

ART.
FBL8020C00000



Par de soportes de fijación de unidad de pared a los montantes

ART.	A mm	P mm	H mm	RAL
FBL8025000008	33	21	455	7035
FBL8025000004	33	21	455	5012

⚠ Para la fijación del armario colgante en los montantes con dos aletas



Barra de leds

Sin tecla on/off

ART.	A mm	Temperatura color K	Watt	Hz	Lumen
FBL99350213	573	4000	10	50/60	1000
FBL99400213	873	4000	15	50/60	1500
FBL99450213	1173	4000	20	50/60	2000



CAPACIDAD



RAL 7035 + RAL 7016



RAL 5012



RAL 7035

COMPONENTS



COMPONENTS

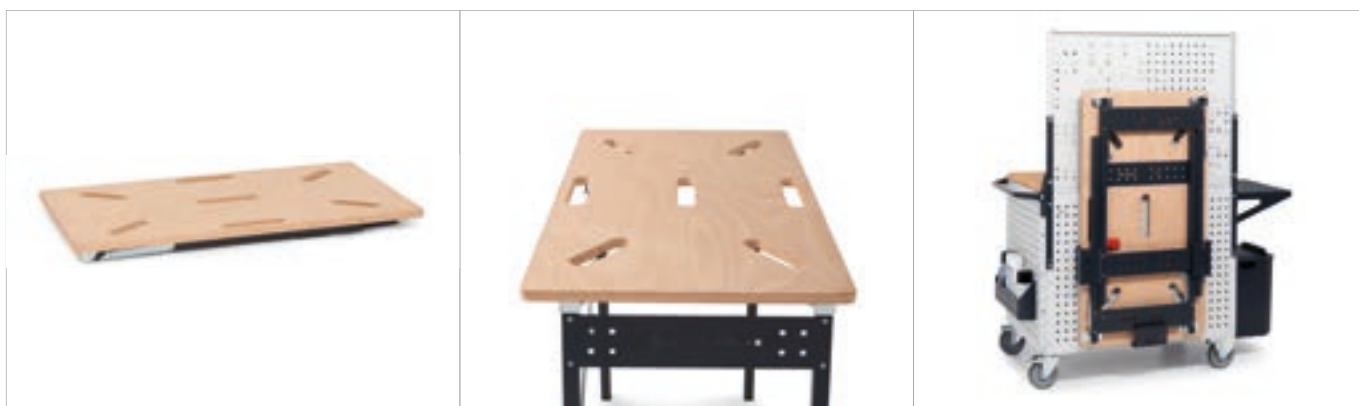

Mesa con patas plegables

ART.	Medidas máx. abierto			Medidas máx. cerrado			Material de la encimera	KG	RAL	
	A mm	P mm	H mm	A mm	P mm	H mm				
F22WWTABLE00039	1184	590	896	1100	590	60	Multiplex	400	7016	



Kit 3 ganchos para fijación vertical de mesa

ART.	A mm	P mm	H mm	KG	RAL	
F22WWTABLEFIS39	152	81	92	25	7016	

KG
CAPACIDAD

RAL 7016

COMPONENTS

Sillas de trabajo



Silla regulable con bomba a gas con ruedas

ART.	A mm	P mm	material	H asiento mm	N. ruedas	
FAX1100RG000000	630	630	Haya	510/690	5	



Silla regulable con bomba a gas con pies

ART.	A mm	P mm	material	H asiento mm	N. pies	color	
FAX120000000007	630	630	Poliuretano	580/840	5	Negro	



Silla regulable con bomba a gas con ruedas

ART.	A mm	P mm	material	H asiento mm	N. ruedas	color	
FAX125000000007	630	630	Poliuretano	540/730	5	Negro	

COMPONENTS

Sillas de trabajo



Silla regulable con bomba a gas con ruedas

ART.	A mm	P mm	material	H asiento mm	N. ruedas	color	
FAXCATY50000007	630	630	Poliuretano	435/565	5	Negro	



Silla regulable con bomba a gas con ruedas

ART.	A mm	P mm	material	H asiento mm	N. ruedas	color	
FAXCATY80000007	630	630	Poliuretano	525/710	5	Negro	



Silla antiestática regulable con bomba de gas y ruedas

ART.	A mm	P mm	material	H asiento mm	N. ruedas	color	
FAXGREF21200001	640	640	Tejido antiestático	470/600	5	Gris oscuro	

ERGO WORK

BRAZOS ARTICULADOS

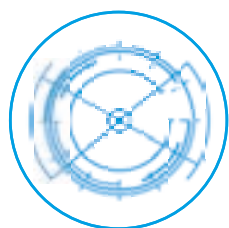

Configurable

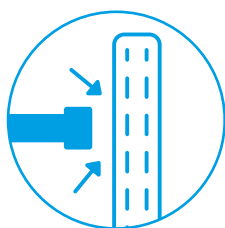

**Fijación sobre
montante**

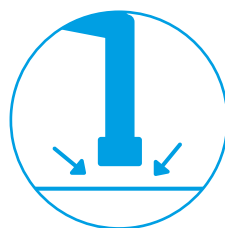

**Fijación sobre
encimera**



Capacidad 20 kg

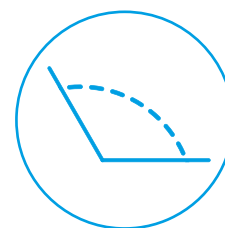

**Ángulo de
rotación 240-
260°**

ERGO WORK



ART.	A mm	P mm	H mm	KG	RAL
DYNAMIC1506	1497/3139	780	1983/2383	400	7035+7016

Compuesto por:

cant.	descripción
1	Banco desmontado regulable eléctricamente
1	Armario A=500 mm con 1 cajón H=150 mm
1	Tapa para armario A=500 mm
1	Par de soportes para armario
1	Bastidor para tomas adicional con tampones y angulares
1	Kit de 2 montantes con dos aletas para bancos
1	Kit de 2 soportes inclinados con guía
1	Lámpara doble
1	Guía suplementaria con fijaciones
1	Set para aire comprimido con compensador y filtro
2	Panel perforado/repisa con borde bloquea caja
3	Lámpara simple
1	Panel perforado/repisa
1	Panel perforado electric
2	Gancho Unipok para herramientas - paquete de 30 unidades
1	Magnetotérmico diferencial

cant.	descripción
1	Toma múltiple Schuko de 4 compartimentos
2	Toma múltiple Schuko de 2 compartimentos
1	Toma USB de recarga
1	Toma USB de datos
1	Cable de conexión Wieland Schuko/FR
1	Dispensador para guantes
1	Porta frasco higienizante reversible
36	Contenedor de polipropileno Picking Box tamaño 2
4	Brazo articulado para montante
1	Articulación para placa
3	Placa porta monitor de acuerdo con standard VESA
1	Panel para Picking Box
3	Barra gancho con 4 contenedores Picking Box tamaño 1
1	Panel para Visual Box
2	Cajonera Visual Box con 6 cajones H=112 mm
1	Cajonera Visual Box con 5 cajones H=164 mm
1	Bandeja inclinada



CAPACIDAD

RAL 7035+RAL 7016



Brazo articulado con Picking Box

ART.	A mm	P mm	H mm	RAL	
ERGOWORK002	760/515	470/283	356	7016	

Compuesto por:

cant.	descripción
1	Brazo articulado para montante
1	Placa porta monitor de acuerdo con standard VESA
1	Panel para Picking Box
3	Barra gancho con 4 contenedores Picking Box tamaño 1



Brazo articulado con Picking Box

ART.	A mm	P mm	H mm	RAL	
ERGOWORK003	826/515	470/348	356	7016	

Compuesto por:

cant.	descripción
1	Brazo articulado para montante
1	Placa porta monitor de acuerdo con standard VESA
1	Panel para Picking Box
1	Barra gancho con 3 contenedores Picking Box tamaño 2
1	Barra gancho con 4 contenedores Picking Box tamaño 1



Brazo articulado con Visual Box

ART.	A mm	P mm	H mm	RAL	
ERGOWORK004	738/612	601/294	390	7016	

Compuesto por:

cant.	descripción
1	Brazo articulado para montante
1	Placa porta monitor de acuerdo con standard VESA
1	Panel para Visual Box
1	Cajonera Visual Box con 5 cajones H=164 mm
2	Cajonera Visual Box con 6 cajones H=112 mm



Placa porta monitor con escuadras

ART.	A mm	P mm	H mm	RAL	
ERGOWORK014	225/129	119/225	225	7016	

Compuesto por:

cant.	descripción
1	Par de escuadras en L
1	Articulación para placa
1	Placa porta monitor de acuerdo con standard VESA



Panel perforado con bisagras

ART.	A mm	P mm	H mm	RAL	
ERGOWORK007	647	50	479	7035	

Compuesto por:

cant.	descripción
1	Panel perforado/repisa con borde bloquea caja
1	Kit de bisagras para panel perforado



Brazo articulado con bandeja inclinada

ART.	A mm	P mm	H mm	RAL	
ERGOWORK005	674/522	425/470	194	7016	

Compuesto por:

cant.	descripción
1	Brazo articulado para montante
1	Bandeja inclinada



Brazo articulado con placa porta monitor

ART.	A mm	P mm	H mm	RAL	
ERGOWORK001	652/330	225/225	225	7016	

Compuesto por:



cant.	descripción
1	Brazo articulado para montante
1	Articulación para placa
1	Placa porta monitor de acuerdo con standard VESA



RAL 7035

RAL 7016



ART.	A mm	P mm	H mm	 Sin ruedas	 set de ruedas	RAL	
CLEVER1031	1036	672	1428	300	300	7035	

Compuesto por:

cant.	descripción	cant.	descripción
1	Carro desmontado sin ruedas	1	Perfil con base para encimera
1	Estante de madera con soportes	1	Par de escuadras en L
2	Panel lateral perforado	1	Articulación para placa
1	Panel trasero perforado	1	Placa porta monitor de acuerdo con standard VESA
1	Par de puertas batientes	1	Kit de ruedas de goma antihuella sintética Ø 125 mm



Brazo articulado con bandeja inclinada

ART.	A mm	P mm	H mm	RAL	
ERGOWORK013	745/521	425/480	552	7016	

Compuesto por:

cant.	descripción
1	Perfil con base para encimera
1	Brazo articulado para perfil
1	Bandeja inclinada

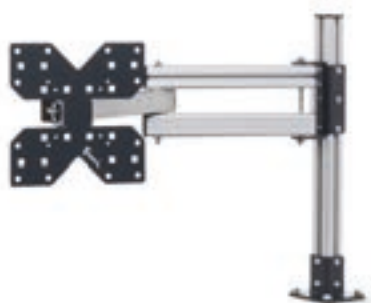

Brazo articulado con placa porta monitor

ART.	A mm	P mm	H mm	RAL	
ERGOWORK009	724/402	225/192	550	7016	

Compuesto por:

cant.	descripción
1	Perfil con base para encimera
1	Brazo articulado para perfil
1	Articulación para placa
1	Placa porta monitor de acuerdo con standard VESA



Perfil con placa porta monitor

ART.	A mm	P mm	H mm	RAL	
ERGOWORK008	225/199	151/225	560	7016	

Compuesto por:

cant.	descripción
1	Perfil con base para encimera
1	Par de escuadras en L
1	Articulación para placa
1	Placa porta monitor de acuerdo con standard VESA



CAPACIDAD



RAL 7016



RAL 7035



Brazo articulado con Picking Box

ART.	A mm	P mm	H mm	RAL	
ERGOWORK010	832/515	470/300	628	7016	

Compuesto por:

cant.	descripción
1	Perfil con base para encimera
1	Brazo articulado para perfil
1	Placa porta monitor de acuerdo con standard VESA
1	Panel para Picking Box
3	Barra gancho con 4 contenedores Picking Box tamaño 1



Brazo articulado con Picking Box

ART.	A mm	P mm	H mm	RAL	
ERGOWORK011	898/515	470/365	628	7016	

Compuesto por:

cant.	descripción
1	Perfil con base para encimera
1	Brazo articulado para perfil
1	Placa porta monitor de acuerdo con standard VESA
1	Panel para Picking Box
1	Barra gancho con 3 contenedores Picking Box tamaño 2
1	Barra gancho con 4 contenedores Picking Box tamaño 1



Brazo articulado con Visual Box

ART.	A mm	P mm	H mm	RAL	
ERGOWORK012	808/601	601/275	668	7016	

Compuesto por:

cant.	descripción
1	Perfil con base para encimera
1	Brazo articulado para perfil
1	Placa porta monitor de acuerdo con standard VESA
1	Panel para Visual Box
1	Cajonera Visual Box con 5 cajones H=164 mm
2	Cajonera Visual Box con 6 cajones H=112 mm

ERGO WORK



ART.	A mm	P mm	H mm	KG	RAL
MASTERBR2008	3347	750	1985/2360	1000	7035+7016

Compuesto por:

cant.	descripción
1	Banco desmontado con encimera de multiplex de 40 mm
1	Cobertura para encimera de multiplex
1	Armario A=560 mm con 4 cajones 1x75 2x150 1x200
1	Armario A=560 mm predispuesto para puerta con 1 estante regulable
1	Puerta total izquierda H=600 mm con asa Dark Grey
2	Medio estante adicional A=560 mm
1	Kit de 2 montantes con dos aletas para bancos
1	Kit de 2 soportes inclinados con guía
1	Guía suplementaria con fijaciones
1	Lámpara doble
1	Kit de 3 paneles perforados/repisas con 2 bordes bloquea caja
1	Panel perforado electric
2	Toma múltiple Schuko de 2 compartimentos
1	Toma múltiple Schuko de 4 compartimentos

cant.	descripción
1	Magnetotérmico diferencial
1	Cable de conexión Wieland Schuko/FR
1	Porta frasco higienizante reversible
1	Dispensador para guantes
1	Kit porta rollo con papel Ø=240 mm
4	Kit de 2 contenedores Picking Box tamaño 3A2
2	Panel perforado/repisa con borde bloquea caja
2	Kit de bisagras para panel perforado
4	Barra gancho con 4 contenedores Picking Box tamaño 1
4	Barra gancho con 3 contenedores Picking Box tamaño 2
2	Perfil con base para encimera
2	Brazo articulado para perfil
1	Bandeja inclinada
1	Articulación para placa
1	Placa porta monitor de acuerdo con standard VESA



CAPACIDAD



RAL 7035 + RAL 7016



RAL 7016

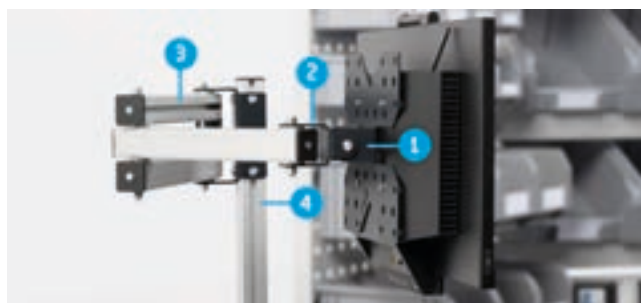

1. Placa porta monitor de acuerdo con standard VESA
2. Articulación para placa
3. Brazo articulado para perfil
4. Perfil con base para encimera

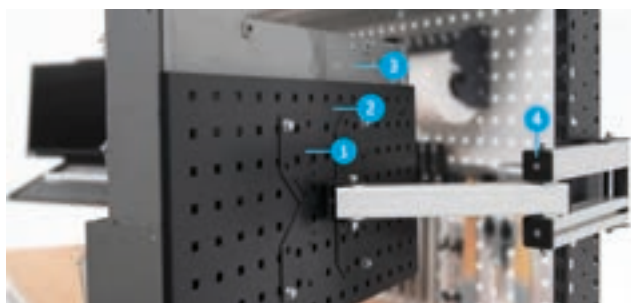

1. Placa porta monitor de acuerdo con standard VESA
2. Panel para Visual Box
3. Cajonera Visual Box con 6 cajones H=112 mm
4. Brazo articulado para montante



Brazo articulado para montante

ART.	A mm	P mm	H mm	Ángulo de rotación °	material	KG	RAL
FBL74100039	580/330	72/97	158	240	Aluminio	20	7016



Brazo articulado para perfil

Para utilizar sobre perfil con base para encimera

ART.	A mm	P mm	H mm	Ángulo de rotación °	material	KG	RAL
FBL74180039	621/371	57/90	158	260	Aluminio	20	7016



Perfil con base para encimera

ART.	A mm	P mm	H mm	apto para	material	KG	RAL
FBL74160039	100	100	504	Encimera de multiplex – encimera de mdf con cobertura de caucho	Aluminio	20	7016



Panel para Visual Box

Para utilizar con placa porta monitor

ART.	A mm	P mm	H mm	Medida del orificio (mm)	Paso mm	KG	RAL
FBL74150039	601	31	313	10x10	38	20	7016

Ver Visual Box en la página 297



Placa porta monitor de acuerdo con standard VESA

Orientable sobre un eje

ART.	A mm	P mm	H mm	RAL	
FBL74120039	225	50	225	7016	



Articulación para placa

Para utilizar con placa porta monitor para orientarla sobre dos ejes

ART.	A mm	P mm	H mm	RAL	
FBL74110039	91	67	51	7016	



Par de escuadras en L

Para utilizar con placa porta monitor

ART.	A mm	P mm	H mm	RAL	
FBL74170039	38	36	32	7016	



Bandeja inclinada

ART.	A mm	P mm	H mm	RAL	
FBL74130039	425	308	135	7016	



1. Bandeja inclinada
2. Brazo articulado para perfil
3. Perfil con base para encimera



CAPACIDAD



RAL 7016



Panel para Picking Box

Para utilizar con placa porta monitor

ART.	A mm	P mm	H mm	apto para	 KG	RAL
FBL74140039	470	12	356	Contenedor Picking Box tamaño 1/2	20	7016



Barra gancho con 4 contenedores Picking Box tamaño 1

ART.	A mm	P mm	H mm	color de los contenedores
FBLIT011000	445	168	85	Gris oscuro
FBLIT012000	445	168	85	Negro



Barra gancho con 3 contenedores Picking Box tamaño 2

ART.	A mm	P mm	H mm	color de los contenedores
FBLIT013000	447	233	123	Gris oscuro
FBLIT014000	447	233	123	Negro

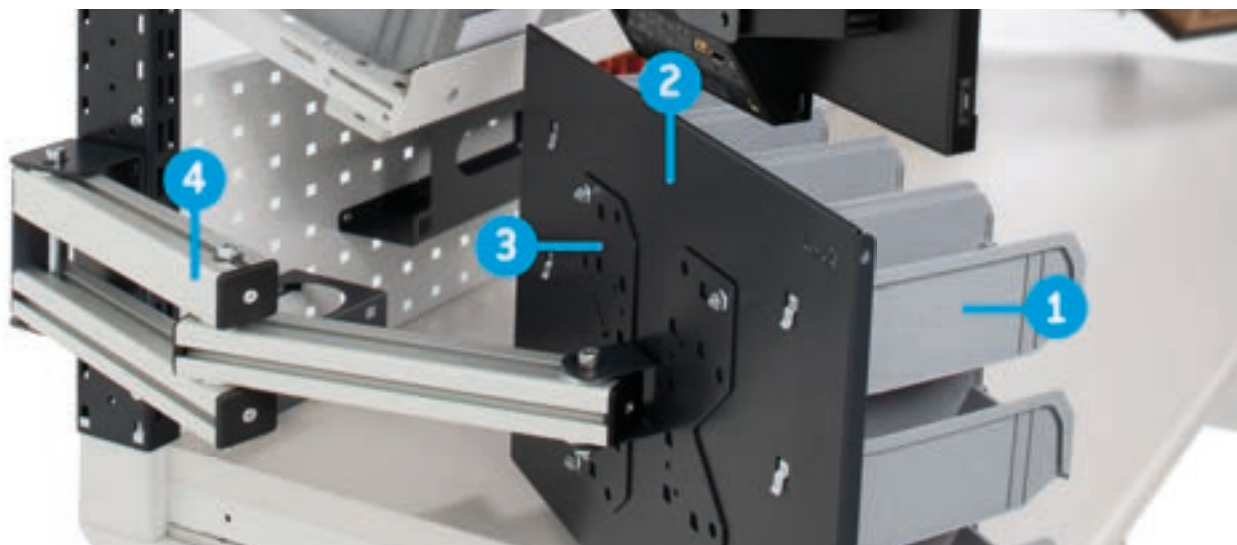

1. Barra gancho con 4 contenedores Picking Box tamaño 1
2. Panel para Picking Box
3. Placa porta monitor de acuerdo con standard VESA
4. Brazo articulado para montante



Panel perforado/repisa

ART.	A mm	P mm	H mm	Medida del orificio (mm)	Paso mm	RAL	
FBL76070008	647	31	304	10x10	38	7035	
FBL76070004	647	31	304	10x10	38	5012	



Panel perforado/repisa con borde bloquea caja

ART.	A mm	P mm	H mm	Medida del orificio (mm)	Paso mm	RAL	
FBL76080108	647	60	456	10x10	38	7035	
FBL76080104	647	60	456	10x10	38	5012	



Kit de bisagras para panel perforado

ART.	A mm	P mm	H mm	
FBL7600011F	64	54	21	



1. Panel perforado/repisa con borde bloquea caja
2. Kit de bisagras para panel perforado



ART.	A mm	P mm	H mm	KG	RAL	
MASTERBR1509	1706/3016	750	1985/2360	1000	7035+7016	

Compuesto por:

cant.	descripción
1	Banco desmontado con encimera de multiplex de 40 mm
1	Armario A=560 mm con 5 cajones 1x75 3x100 1x200
2	Estante superior/inferior A=560 mm
1	Puerta total izquierda H=600 mm con asa Dark Grey
1	Estante interno A=558 mm
1	Soporte para medio estante intermedio
2	Panel perforado lateral
1	Kit de 2 montantes con dos aletas para bancos
1	Kit 2 paneles perforados/repisas con 1 borde bloquea caja
1	Kit de 2 soportes inclinados con guía
1	Lámpara doble
1	Unidad de pared de apertura basculante sin cerradura
1	Barra de leds
1	Par de soportes de fijación de unidad de pared a los montantes

cant.	descripción
3	Brazo articulado para montante
1	Articulación para placa
2	Placa porta monitor de acuerdo con standard VESA
1	Bandeja inclinada
1	Panel para Visual Box
1	Cajonera Visual Box con 5 cajones H=164 mm
2	Cajonera Visual Box con 6 cajones H=112 mm
1	Canasta de 30 l de capacidad
2	Porta bombonas inclinado de 2 puestos
1	Bolsillo porta documentos A4
1	Kit porta rollo con papel Ø 130 mm
3	Gancho Unipok para herramientas - paquete de 30 unidades
1	Barra gancho con 4 contenedores Picking Box tamaño 1
1	Barra gancho con 3 contenedores Picking Box tamaño 2

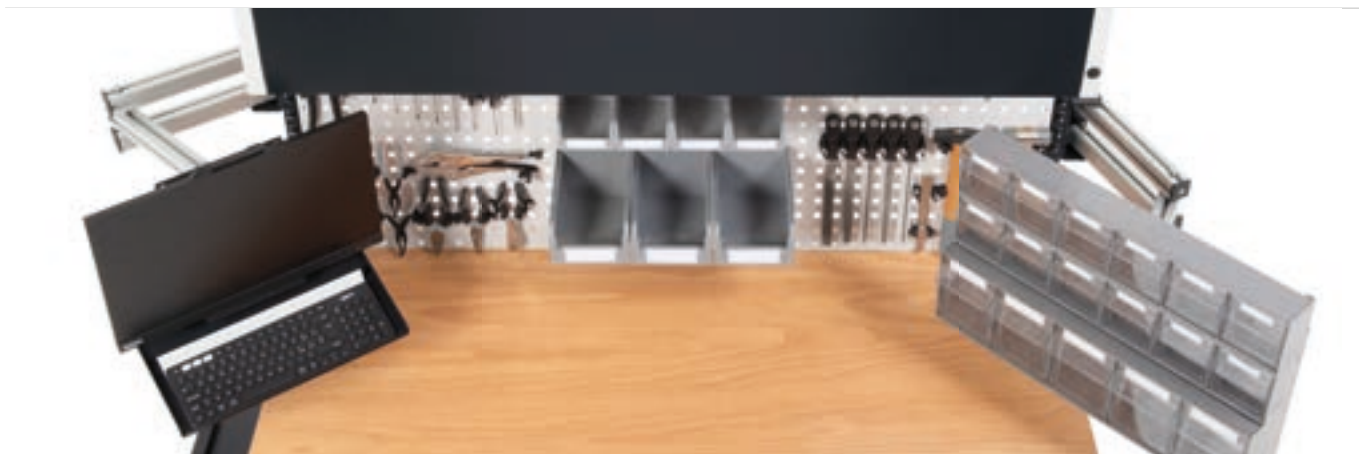



ART.	A mm	P mm	H mm	KG	RAL
DYNAMIC1505	1497/1672	780	1983/2383	400	7035+7016

Compuesto por:

cant.	descripción	cant.	descripción
1	Banco desmontado regulable eléctricamente	1	Magnetotérmico diferencial
1	Armario A=500 mm con 1 cajón H=150 mm	1	Toma múltiple Schuko de 4 compartimentos
1	Tapa para armario A=500 mm	2	Toma múltiple Schuko de 2 compartimentos
1	Par de soportes para armario	1	Cable de conexión Wieland Schuko/FR
1	Bastidor para tomas adicional con tampones y angulares	1	Par de escuadras en L
1	Kit de 2 montantes con dos aletas para bancos	1	Articulación para placa
1	Par de soportes para pared equipada A=1000 mm	1	Placa porta monitor de acuerdo con standard VESA
1	Kit de 2 soportes inclinados con guía	2	Panel perforado/repisa con borde bloquea caja
1	Lámpara doble	2	Kit de bisagras para panel perforado
1	Kit de 3 paneles perforados/repisas con 2 bordes bloquea caja	2	Barra gancho con 4 contenedores Picking Box tamaño 1
1	Panel perforado electric	2	Barra gancho con 3 contenedores Picking Box tamaño 2
4	Kit de 2 contenedores Picking Box tamaño 3A2	2	Porta bombonas inclinado de 2 puestos



CAPACIDAD



RAL 7035+RAL 7016

TOOL ORGANIZER





Gancho Unipok para herramientas - paquete de 30 unidades
Con 1 paquete se pueden enganchar hasta 30 herramientas

ART.	ud. por paquete	color	
FBLIT009007	30	Negro	



Unipok son los nuevos **ganchos universales** de Fami que, gracias al sistema con rosca, pueden aplicarse a tabiques perforados o a paneles de madera. Cada Unipok se puede instalar con distintas inclinaciones para fijar herramientas de diferentes medidas y volúmenes. Da rienda suelta a tu fantasía para organizar de manera óptima tu tabique perforado de pared o de banco y tus paneles de madera, y tener todo siempre al alcance de la mano.

¡Con Unipok el orden es un juego de niños!



Fijación sobre madera



Fijación sobre panel perforado

En 4 posiciones, ¡todas las combinaciones que desees!

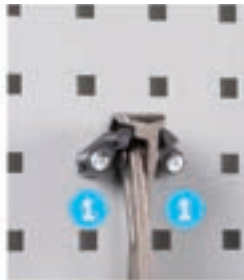
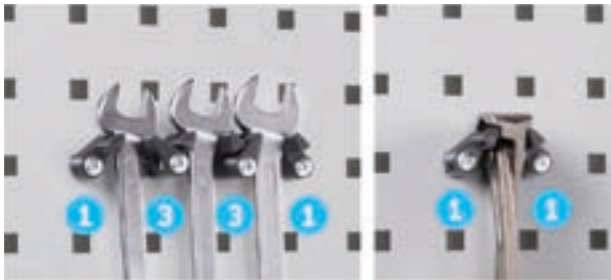



Gancho con puntal

ART.	A mm	P mm	H mm	unidad de venta
FBLIT030000	36	78	42	10
FBLIT031000	36	128	42	10
FBLIT032000	36	178	42	10

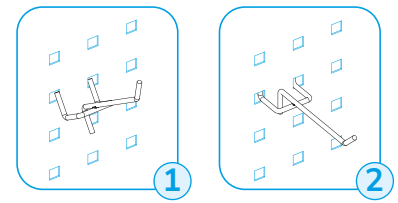
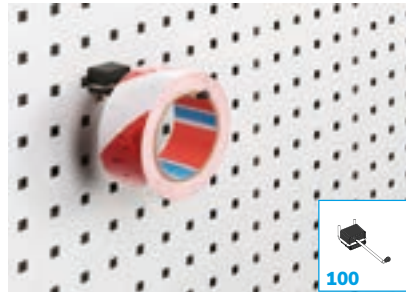

1

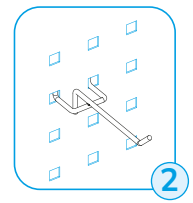

2

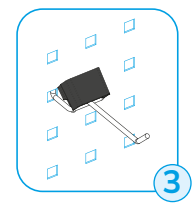

3

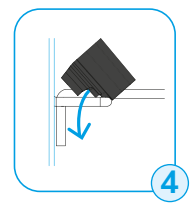

4

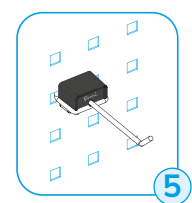

5

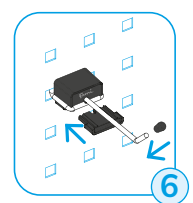

6

El bloqueo de seguridad detiene el gancho en posición horizontal e impide que se mueva durante las operaciones de recogida/depósito de herramientas.





Panel perforados consultar pág. 60 / 61
Fijación de pared de paneles perforados consultar pág. 62
Ganchos Unipok consultar pág. 85
Ganchos The Block consultar pág. 86
Accesorios Iron Team consultar pág. 90



¡CREAR LA PERFECTA 5S SHADOW TOOL BOX CON PIKPAD!

Con **Pikpad** es posible configurar una **5S shadow tool box** organizada hasta el más mínimo detalle. El fondo de orificios cuadrados 10x10 de la bandeja permite la instalación de **Unipok** para crear **kits** a medida para cada trabajo a realizar y, gracias a las prácticas etiquetas **para herramientas**, será posible identificar el tipo de herramienta que cabe en cada espacio creado.

Pikpad se suministra con un juego de 5 hojas adhesivas:

- 4 hojas con más de 250 etiquetas de herramientas (forma + tamaño de la herramienta)
- 1 hoja no precortada para hacer adhesivos personalizados

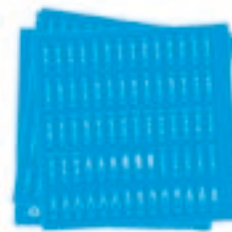

Unipok debe adquirirse por separado

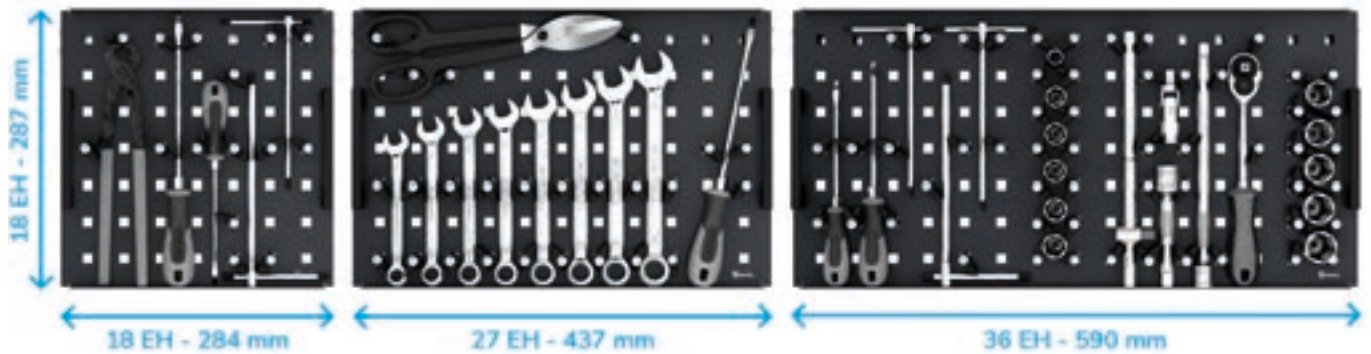

Bandeja Pikpad 5S shadow tool box

ART.	anchura EH	profundidad EH	A mm	P mm	H mm	RAL
FBLIT033039	18	18	284	287	50	7016
FBLIT034039	27	18	437	287	50	7016
FBLIT035039	36	18	590	287	50	7016

Unipok y herramientas exclusivas



Soporte de mesa para bandeja Pikpad 5S shadow tool box

ART.	A mm	P mm	H mm	RAL
PIKPAD001	653	255	198	7016
PIKPAD002	959	255	198	7016
PIKPAD003	1444	255	198	7016



3 POSICIONES DE REGULACIÓN

El **perfil patentado** integrado en la parte posterior de Pikpad permite **regular** la bandeja en **3 diferentes proporciones**. Así, es posible ajustar la inclinación del Pikpad en función de la altura y la postura del usuario, para que todo esté al alcance de la mano y trabajar según los principios de la **ergonomía**.



ORGANIZACIÓN MÓVIL

Las 5S shadow tool box hacen que la organización de los equipos sea móvil, ya que pueden instalarse en diferentes soportes y desplazarse fácilmente mediante asas laterales. Pueden colocarse sobre superficies de mesa utilizando el soporte de mesa especial, en los montantes de las paredes equipadas con barras de aluminio y en el interior de los cajones. En este último caso, es posible aumentar exponencialmente la organización interna de las cajoneras integrando Pikpad con los materiales de separación tradicionales, como las cajas separadoras y los separadores metálicos.



IRONTEAM

ACCESORIOS UNIVERSALES



Fijación sobre madera



Fijación sobre panel perforado



Fijación en pared

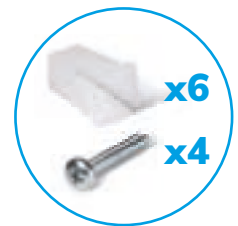

Set de fijación sobre madera y panel perforado incluido



Porta silicona inclinado de 2 puestos

ART.	A mm	P mm	H mm	Ø orificio mm	RAL
FBLIT008039	150	71	96	61	7016



Porta bombonas inclinado de 2 puestos

ART.	A mm	P mm	H mm	Ø orificio mm	RAL
FBLIT007039	188	111	172	70	7016



Porta bombonas de 6 puestos

ART.	A mm	P mm	H mm	RAL
FBLIT010039	455	75	167	7016



Kit porta contenedor con contenedor de toallitas lavamanos

ART.	RAL
FBLIT006039	7016



Kit porta rollo con papel Ø=240 mm

ART.	A mm	P mm	H mm	RAL
FBLIT004039	297	275	270	7016



Kit porta rollo con papel Ø 130 mm

ART.	A mm	P mm	H mm	RAL
FBLIT003039	257	135	168	7016



Porta frasco higienizante reversible

ART.	A mm	P mm	H mm	RAL
FBLIT002039	113	100	62	7016



Dispensador para guantes

ART.	A mm	P mm	H mm	RAL
FBLIT005039	247	81	132	7016



Imán con clip y tornillo - paquete de 10 unidades



ART.	ud. por paquete	Ø mm	Acabado
FBL95410000	10	20	Galvanizado



Armario colgante con puerta

ART.	A mm	P mm	H mm	KG	RAL
FBL8015C000PD	460	250	456	25	7035+7016
FBL8015C00004	460	250	456	25	5012





Barra gancho con 4 contenedores Picking Box tamaño 1

ART.	A mm	P mm	H mm	color de los contenedores	
FBLIT011000	445	168	85	Gris oscuro	
FBLIT012000	445	168	85	Negro	



Barra gancho con 3 contenedores Picking Box tamaño 2

ART.	A mm	P mm	H mm	color de los contenedores	
FBLIT013000	447	233	123	Gris oscuro	
FBLIT014000	447	233	123	Negro	



Barra gancho contenedores Picking Box tamaño 1/2

ART.	A mm	P mm	H mm	Acabado	
FBLIT020099	445	9	85	Galvanizado	



Kit porta contenedor

ART.	Long. correa mm	RAL	
FBLIT018039	910	7016	

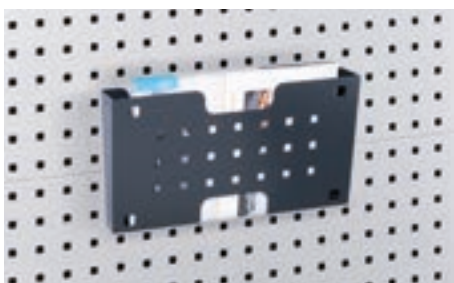

Bolsillo porta documentos A4

ART.	A mm	P mm	H mm	RAL	
FBLIT001039	365	68	187	7016	



Kit de primeros auxilios

ART.	A mm	P mm	H mm	
FBLIT024000	256	90	190	



Porta extintor con extintor de 2 kg

ART.	A mm	P mm	H mm	
FBLIT023000	115	115	400	



Asiento sujetacables

ART.	A mm	P mm	H mm	RAL	
FBLIT019039	220	95	101	7016	

GALVANIZADO
 RAL 5012
 RAL 7035 + RAL 7016
 RAL 7016



Placa porta monitor con escuadras

ART.	A mm	P mm	H mm	RAL	
ERGOWORK014	225/129	119/225	225	7016	

Compuesto por:

cant.	descripción
1	Par de escuadras en L
1	Articulación para placa
1	Placa porta monitor de acuerdo con standard VESA



Canasta de 30 l de capacidad

ART.	A mm	P mm	H mm	L	RAL	
FBLIT025039	387	277	394	30	7016	



Maletín con contenedores

ART.	A mm	P mm	H mm	
FBLIT022001	440	350	80	

Kit porta maletín

ART.	RAL	
FBLIT021039	7016	



Repisa pequeña reversible

ART.	A mm	P mm	H mm	RAL
FBLIT017039	303	317	144	7016



Repisa grande reversible

ART.	A mm	P mm	H mm	RAL
FBLIT016039	455	317	144	7016

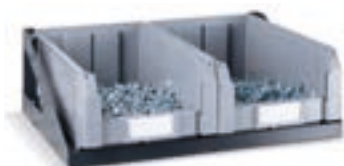

Kit de 2 contenedores Picking Box tamaño 3A2

ART.	A mm	P mm	H mm	color
FBLIT027001	200	350	145	Gris oscuro



Kit de 10 contenedores

ART.
FBLIT028000



Repisa porta objetos reversible

ART.	A mm	P mm	H mm	RAL
FBLIT015039	455	160	40	7016



Porta brocas

ART.	A mm	P mm	H mm	Acabado
FBLIT0260ZZ	155	84	39	Inox

El porta brocas se puede utilizar en la repisa porta objetos reversible



CAPACIDAD



INOX



RAL 7016



Soporte para interruptor magnetotérmico diferencial

ART.	A mm	P mm	H mm	RAL
FBLET003039	159	32	92	7016



Magnetotérmico diferencial 2P+T 16A, 30mA TYPE A

ART.	A mm	P mm	H mm	color
FBLET012007	159	59	90	Negro



Soporte toma múltiple de 2 compartimentos

ART.	A mm	P mm	H mm	RAL
FBLET001039	148	32	92	7016



Soporte toma múltiple de 4 compartimentos

ART.	A mm	P mm	H mm	RAL
FBLET002039	249	32	92	7016



Toma múltiple de 2 puestos

ART.	A mm	P mm	H mm	Tipo de toma	color
FBLET004007	148	59	46	Schuko	Negro
FBLET006007	148	59	46	CH	Negro
FBLET008007	148	59	46	GB	Negro
FBLET010007	148	59	46	FR	Negro



Toma múltiple de 4 puestos

ART.	A mm	P mm	H mm	Tipo de toma	color
FBLET005007	248	59	46	Schuko	Negro
FBLET007007	248	59	46	CH	Negro
FBLET009007	248	59	46	GB	Negro
FBLET011007	248	59	46	FR	Negro



Cable de conexión Wieland con clavijas in/out

ART.	A mm	P mm	H mm	color	
FBLET013007	200	28	13	Negro	



Conector en H Wieland con 2 salidas

ART.	A mm	P mm	H mm	color	
FBLET015007	60	35	35	Negro	



Cable de conexión Wieland

ART.	A mm	P mm	H mm	Tipo de clavija	color	
FBLET016007	3000	50	50	Schuko/Francesa	Negro	
FBLET017007	3000	50	50	GB	Negro	
FBLET018007	3000	50	50	CH	Negro	



Cable de conexión Wieland con clavijas in/out

ART.	A mm	P mm	H mm	color	
FBLET014007	1500	28	13	Negro	





Toma USB de datos

ART.	Ø mm	A mm	H mm	color	
FBLET019007	59	70	54	Negro	



Toma USB de recarga

ART.	Ø mm	A mm	H mm	color	
FBLET020007	59	70	54	Negro	



Lámpara A=988 mm con soportes de fijación

ART.	A mm	Temperatura color K	Watt	Hz	Lumen	RAL	
IRONTEAM001	988	4000	27	50	5058	7016	



Lámpara A=1473 mm con soportes de fijación

ART.	A mm	Temperatura color K	Watt	Hz	Lumen	RAL	
IRONTEAM002	1473	4000	41	50	7588	7016	



Lámpara simple

Sin tecla on/off

ART.	A mm	Temperatura color K	Watt	Hz	Lumen	RAL	
FBL99400008	955	4000	15	50/60	1500	7035	
FBL99450008	1440	4000	20	50/60	2000	7035	



Lámpara doble

Sin tecla on/off

ART.	A mm	Temperatura color K	Watt	Hz	Lumen	RAL	
FBL99400108	955	4000	15	50/60	3000	7035	
FBL99450108	1440	4000	20	50/60	4000	7035	



Ejemplo de fijación guía aérea



Ejemplo de fijación a panel perforado mediante soportes



Ejemplo de fijación con imán



FLEXA

ARMARIOS CON CAJONES SERIE START



Capacidad de los
cajones de 50 a 70 kg

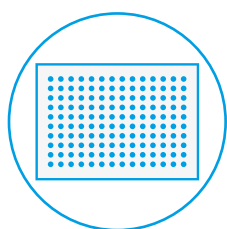

Cajones perforados



Cojinetes de bolas



Cierre con llave

FLEXA

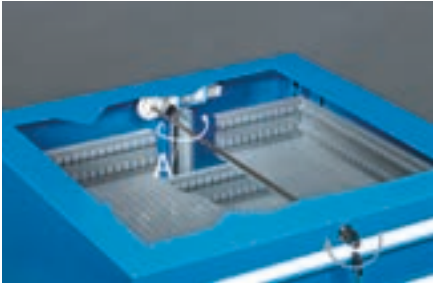

CERRADURA

La cerradura a cilindro se conecta mediante una varilla cuadrada al grupo de cierre trasero compuesto de un elemento giratorio plástico y una varilla de cierre en chapa de acero. Girando la llave se acciona el sistema de levas del grupo de cierre que hace girar la varilla trasera (A).



ENCIMERA DE 3 BORDES REVESTIDA DE PVC

El top de 3 bordes revestido en PVC protege la parte superior del armario y, gracias a los bordes elevados, evita la caída del material en él colocado.



DE ORGANIZACIÓN LIBRE

El cajón puede subdividirse internamente mediante **cajas divisorias portadoras de piezas pequeñas y divisores longitudinales y transversales de metal**. Estos últimos se fijan con tornillos al fondo perforado del cajón para evitar la salida del material almacenado.



CAJONES PERFORADOS



ORGANIZACIÓN AL MILÍMETRO
Los orificios y acanalados en los cajones facilitan la subdivisión interna del cajón, para una perfecta organización de herramientas y materiales.



EXTRACCIÓN TOTAL
100%



CAPACIDAD
50 / 70 kg

COLORES

El armario Flexa está disponible en 3 combinaciones de colores.

ARMARIO



7016
7035



7035



5012

NOTA

EH		36X27 EH	54X27 EH
	Dimensiones armario	A= 717	1023
		P= 600	600
	Dimensiones internas cajón	A= 602	908
		P= 449	449

Cajonera A=717 mm - Cajones de extracción total



ART.	A mm	P mm	H mm	cajones							RAL
				n.º	h 75 mm	h 100 mm	h 150 mm	h 200 mm	KG	🔽	
FD F109054PD	717	600	1002	7	2	1	3	1	70	100%	7035+7016
FD F10905408	717	600	1002	7	2	1	3	1	70	100%	7035
FD F10905404	717	600	1002	7	2	1	3	1	70	100%	5012
FD F109056PD	717	600	1002	9	-	9	-	-	70	100%	7035+7016
FD F10905608	717	600	1002	9	-	9	-	-	70	100%	7035
FD F10905604	717	600	1002	9	-	9	-	-	70	100%	5012



ART.	A mm	P mm	H mm	KG	cajones					Ruedas					RAL	
					n.º	h 100 mm	h 200 mm	KG	🔽	Ø mm	H mm	material	🔽	🔽		🔽
FDGD56001PD	794	600	853	225	5	4	1	70	100%	100	128	Goma standard	1	1	2	7035+7016
FDGD5600108	794	600	853	225	5	4	1	70	100%	100	128	Goma standard	1	1	2	7035
FDGD5600104	794	600	853	225	5	4	1	70	100%	100	128	Goma standard	1	1	2	5012

🔽 RUEDA GIRATORIA

🔽 RUEDA GIRATORIA CON FRENO

🔽 RUEDA FIJA



Encimera de 4 bordes revestida de PVC

ART.	A mm	P mm	H mm	color
FDf99400107	717	602	22	Negro

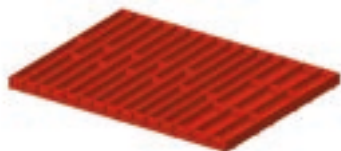

ART.	apto para cajón H mm	componentes	
FFH10051000	50/300	3 x Divisor de 3 canales 9 x Divisor de 4 canales 12 x Divisor transversal A=47 mm 36 x Divisor transversal A=36 mm	

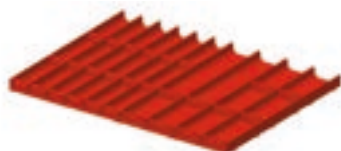

ART.	apto para cajón H mm	componentes	
FFH10051300	50/300	18 x Divisor transversal A=47 mm 12 x Divisor transversal A=73 mm 6 x Divisor de 2 canales 6 x Divisor de 3 canales	

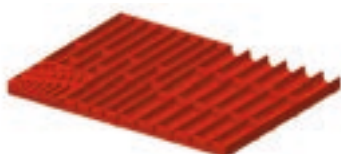

ART.	apto para cajón H mm	componentes	
FFH10051500	50/300	20 x Divisor transversal A=36 mm 20 x Divisor transversal A=47 mm 6 x Divisor de 3 canales 5 x Divisor de 4 canales 1 x Porta llaves Allen	

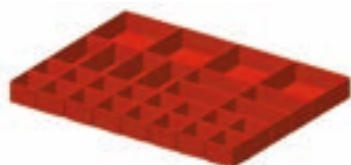

ART.	apto para cajón H mm	componentes	
FFH10071800	75	16 x Caja divisor 75x75 mm 8 x Caja divisor 150x75 mm 4 x Caja divisor 150x150 mm	

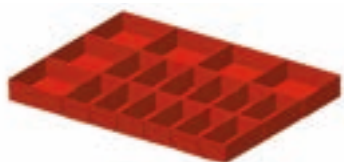

ART.	apto para cajón H mm	componentes	
FFH10071600	75	12 x Caja divisor 150x75 mm	
FFH10101600	100/125	6 x Caja divisor 150x150 mm	

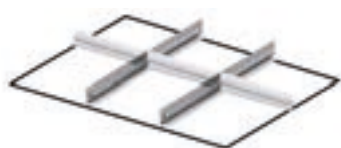

ART.	apto para cajón H mm	componentes	
FFH10070500	75	2 x Separador longitudinal ranurado A=457 mm 3 x Divisor transversal A=202 mm	
FFH10100500	100/125		
FFH10150500	150/175		
FFH10200500	200/250		



EXTRACCIÓN



CAPACIDAD



RAL 7035 + RAL 7016



RAL 5012



RAL 7035

Cajonera A=1023 mm - Cajones de extracción total



ART.	A mm	P mm	H mm	cajones					🏋️	🔧	RAL	
				n.º	h 75 mm	h 100 mm	h 150 mm	h 200 mm				
FDL109054PD	1023	600	1002	7	2	1	3	1	50	100%	7035+7016	
FDL10905408	1023	600	1002	7	2	1	3	1	50	100%	7035	
FDL10905404	1023	600	1002	7	2	1	3	1	50	100%	5012	
FDL109056PD	1023	600	1002	9	-	9	-	-	50	100%	7035+7016	
FDL10905608	1023	600	1002	9	-	9	-	-	50	100%	7035	
FDL10905604	1023	600	1002	9	-	9	-	-	50	100%	5012	





Encimera de 3 bordes revestida de PVC

ART.	A mm	P mm	H mm	color
FDL91500107	1024	601	30	Negro



ART.	apto para cajón H mm	componentes
FFH40051200	50/300	15 x Divisor transversal A=36 mm 10 x Divisor transversal A=47 mm 6 x Divisor transversal A=73 mm 6 x Divisor de 2 canales 6 x Divisor de 3 canales 6 x Divisor de 4 canales

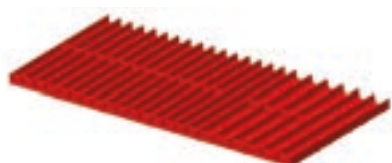

ART.	apto para cajón H mm	componentes
FFH40051500	50/300	30 x Divisor transversal A=36 mm 10 x Divisor transversal A=47 mm 6 x Divisor de 3 canales 12 x Divisor de 4 canales

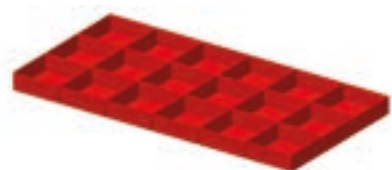

ART.	apto para cajón H mm	componentes
FFH40071100	75	18 x Caja divisor 150x150 mm
FFH40101100	100/125	

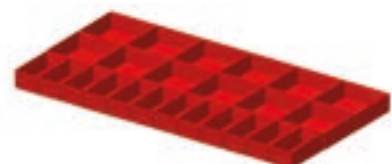

ART.	apto para cajón H mm	componentes
FFH40071300	75	12 x Caja divisor 150x75 mm 12 x Caja divisor 150x150 mm
FFH40101300	100/125	



ART.	apto para cajón H mm	componentes
FFH40071600	75	20 x Caja divisor 75x75 mm 14 x Caja divisor 150x75 mm 6 x Caja divisor 150x150 mm

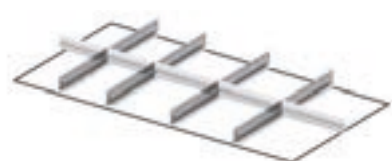

ART.	apto para cajón H mm	componentes
FFH40070500	75	4 x Separador longitudinal ranurado A=457 mm 2 x Divisor transversal A=151 mm 3 x Divisor transversal A=202 mm
FFH40100500	100/125	
FFH40150500	150/175	
FFH40200500	200/250	



EXTRACCIÓN



CAPACIDAD



RAL 7035 + RAL 7016



RAL 5012



RAL 7035

MASTER DE

ARMARIOS CON CAJONES SERIE PRO



Capacidad de los
cajones de 50 a 100 kg

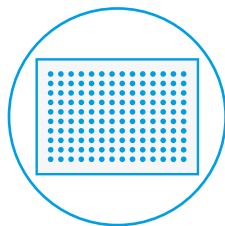

Cajones perforados

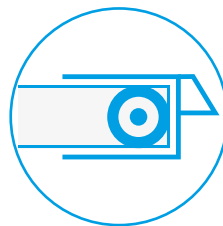

Cojinetes de bolas



Cierre con llave

MASTER DE



TOP DE ACERO INOX SATINADO

El top de acero inoxidable satinado permite realizar trabajos e intervenciones sin dañar el armario. Presenta un elevado nivel de resistencia a la corrosión y al calor.



TOP DE MULTIPLEX

El top en multiplex transforma la parte superior del armario en una superficie de trabajo sólida y robusto. Resiste a golpes y rasguños y se adapta a operaciones pesadas.



TOP DE ACERO DE GOMA

El top está hecho en acero galvanizado y está revestido con goma antiaceite. Está indicado particularmente en caso de uso de aceites o para intervenciones que impliquen el uso de instrumentos de corte.



ENCIMERA DE 3 BORDES REVESTIDA DE PVC

El top de 3 bordes revestido en PVC protege la parte superior del armario y, gracias a los bordes elevados, evita la caída del material en él colocado.



ZÓCALOS

Los zócalos tienen una doble función: elevan el armario a cajones desde el suelo y permiten su movimiento mediante carros elevadores o transpaleta.

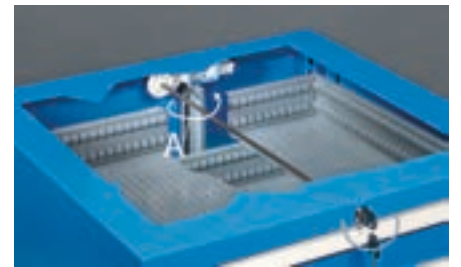

CERRADURA

La cerradura a cilindro se conecta mediante una varilla cuadrada al grupo de cierre trasero compuesto de un elemento giratorio plástico y una varilla de cierre en chapa de acero. Girando la llave se acciona el sistema de levas del grupo de cierre que hace girar la varilla trasera (A).



EXTRACCIÓN TOTAL



LIBERTAD DE CONFIGURACIÓN
Modifica rápida y fácilmente la extracción del cajón para aumentar la capacidad hasta 100 kg.



GUÍAS DE ALTAS PRESTACIONES



CORRER SIN PROBLEMAS
Las guías de la misma longitud de los cajones permiten desplazar el cojinete en la parte frontal del armario aumentando la visibilidad, la capacidad y la extracción.



CAJONES PERFORADOS



ORGANIZACIÓN AL MILÍMETRO
Los orificios y acanalados en los cajones facilitan la subdivisión interna del cajón, para una perfecta organización de herramientas y materiales.

MASTER DE

EXTRACCIÓN Y GESTIÓN DEL CAJÓN

El cajón Master DE representa una revolución en el mundo del mobiliario industrial en cuanto a que fue ideado y desarrollado para ser personalizado de forma autónoma en términos de extracción/capacidad y subdivisión interna.

DE CONFIGURACIÓN LIBRE

La nueva guía de **extracción flexible** permite la regulación mecánica del retén trasero del cajón/estante extraíble, en **3 distintas posiciones** obteniendo así **3 capacidades diferentes: 50, 75, 100 kg**. Una etiqueta indica la capacidad máxima del cajón según su extracción y tipo de guía.

GUÍA FLEXIBLE CONFIGURADA PARA EXTRACCIÓN TOTAL DE 50 KG



GUÍA FLEXIBLE CONFIGURADA PARA EXTRACCIÓN TOTAL DE 75 KG



GUÍA FLEXIBLE CONFIGURADA PARA EXTRACCIÓN PARCIAL DE 100 KG



DE ORGANIZACIÓN LIBRE

El cajón puede subdividirse internamente mediante **cajas divisorias portadoras de piezas pequeñas y divisores longitudinales y transversales de metal**.

Estos últimos se fijan con tornillos al fondo perforado del cajón para evitar la salida del material almacenado.



MASTER DE



Las innovaciones que simplifican la identificación de los contenidos en el interior de los cajones.

Con la tecnología Syfront de Sylogik® el frontal del cajón ya no es más solo un elemento de cierre, se transforma también en una verdadera interfaz visual.

- Personalización con los elementos estéticos y decorativos
- Input usuario: etiquetas para la descripción y catalogación del contenido
- Output usuario: posibilidad de introducir mensajes visuales o descriptivos en la manija

ASAS PERSONALIZABLES

UNA MINA DE INFORMACIÓN
Añade al asa códigos de barras, etiquetas o imágenes para poder conocer rápidamente el contenido de cada cajón.



COLORES

El armario Master DE está disponible en 3 combinaciones de colores para el cuerpo del armario, mientras que la manija está disponible solo en Dark Grey.

ARMARIO



7016
7035



7035



5012

ASA FRONTAL



Dark Grey

NOTA

EH

36X36EH 54X36EH

PR

Estante regulable



Dimensiones armario A= 714 1020
P= 726 726



Dimensiones internas cajón A= 602 908
P= 602 602



MASTER DE 36X36 EH

Cajonera A=714 mm - Cajones de extracción total



ART.	A mm	P mm	H mm	cajones									RAL	
				n.º	h 50 mm	h 75 mm	h 100 mm	h 150 mm	h 200 mm	h 300 mm	KG			
D33A100C0100104	714	726	1000	6	-	-	-	6	-	-	100-75-50	92-96-100%	5012	
D33A100C0100108	714	726	1000	6	-	-	-	6	-	-	100-75-50	92-96-100%	7035	
D33A100C01001PD	714	726	1000	6	-	-	-	6	-	-	100-75-50	92-96-100%	7035+7016	
D33A100C0100204	714	726	1000	7	1	2	2	-	1	1	100-75-50	92-96-100%	5012	
D33A100C0100208	714	726	1000	7	1	2	2	-	1	1	100-75-50	92-96-100%	7035	
D33A100C01002PD	714	726	1000	7	1	2	2	-	1	1	100-75-50	92-96-100%	7035+7016	



ART.	A mm	P mm	H mm	cajones									RAL	
				n.º	h 50 mm	h 75 mm	h 100 mm	h 150 mm	h 200 mm	KG				
D33A100C0100304	714	726	1000	8	1	2	2	2	1	100-75-50	92-96-100%	5012		
D33A100C0100308	714	726	1000	8	1	2	2	2	1	100-75-50	92-96-100%	7035		
D33A100C01003PD	714	726	1000	8	1	2	2	2	1	100-75-50	92-96-100%	7035+7016		
D33A100C0100404	714	726	1000	9	-	-	9	-	-	100-75-50	92-96-100%	5012		
D33A100C0100408	714	726	1000	9	-	-	9	-	-	100-75-50	92-96-100%	7035		
D33A100C01004PD	714	726	1000	9	-	-	9	-	-	100-75-50	92-96-100%	7035+7016		

MASTER DE MATERIAL DE SEPARACIÓN

A= 714 MM

36X36 EH

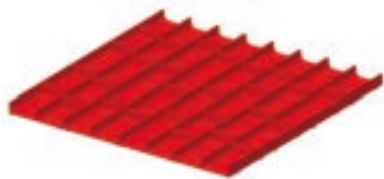

ART.	apto para cajón H mm	componentes	
FFH20051500	50/300	35 x Divisor transversal A=73 mm 16 x Divisor de 2 canales	

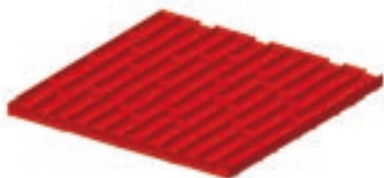

ART.	apto para cajón H mm	componentes	
FFH20051600	50/300	50 x Divisor transversal A=47 mm 16 x Divisor de 3 canales	

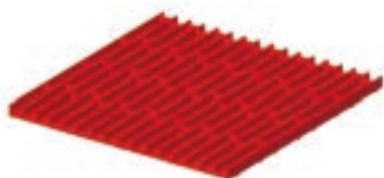

ART.	apto para cajón H mm	componentes	
FFH20051700	50/300	65 x Divisor transversal A=36 mm 16 x Divisor de 4 canales	

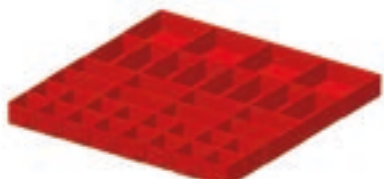

ART.	apto para cajón H mm	componentes	
FFH20051200	50	16 x Caja divisor 75x75 mm 16 x Caja divisor 150x75 mm 4 x Caja divisor 150x150 mm	
FFH20071200	75		

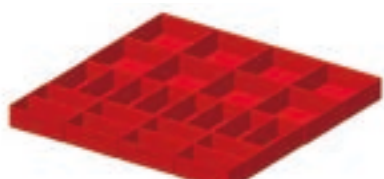

ART.	apto para cajón H mm	componentes	
FFH20051300	50	16 x Caja divisor 150x75 mm 8 x Caja divisor 150x150 mm	
FFH20071300	75		
FFH20101300	100/125		

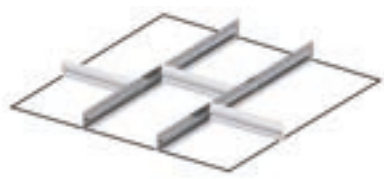

ART.	apto para cajón H mm	componentes	
FFH20050600	50	2 x Separador longitudinal ranurado A=610 mm 3 x Divisor transversal A=202 mm	
FFH20070600	75		
FFH20100600	100/125		
FFH20150600	150/175		
FFH20200600	200/250		
FFH20300600	300		



EXTRACCIÓN



CAPACIDAD



RAL 7035 + RAL 7016



RAL 5012



RAL 7035

MASTER DE 54X36 EH

Cajonera A=1020 mm - Cajones de extracción total



ART.	A mm	P mm	H mm	cajones				RAL	
				n.º	h 150 mm	KG			
D53A100C0100104	1020	726	1000	6	6	100-75-50	92-96-100%	5012	
D53A100C0100108	1020	726	1000	6	6	100-75-50	92-96-100%	7035	
D53A100C01001PD	1020	726	1000	6	6	100-75-50	92-96-100%	7035+7016	



ART.	A mm	P mm	H mm	cajones									RAL	
				n.º	h 50 mm	h 75 mm	h 100 mm	h 150 mm	h 200 mm	h 300 mm	KG			
D53A100C0100204	1020	726	1000	7	1	2	2	-	1	1	100-75-50	92-96-100%	5012	
D53A100C0100208	1020	726	1000	7	1	2	2	-	1	1	100-75-50	92-96-100%	7035	
D53A100C01002PD	1020	726	1000	7	1	2	2	-	1	1	100-75-50	92-96-100%	7035+7016	
D53A100C0100304	1020	726	1000	8	1	2	2	2	1	-	100-75-50	92-96-100%	5012	
D53A100C0100308	1020	726	1000	8	1	2	2	2	1	-	100-75-50	92-96-100%	7035	
D53A100C01003PD	1020	726	1000	8	1	2	2	2	1	-	100-75-50	92-96-100%	7035+7016	

MASTER DE MATERIAL DE SEPARACIÓN

A= 1020 MM 54X36 EH

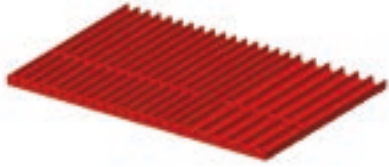

ART.	apto para cajón H mm	componentes	
FFH50051900	50/300	30 x Divisor transversal A=36 mm 10 x Divisor transversal A=47 mm 8 x Divisor de 3 canales 16 x Divisor de 4 canales	

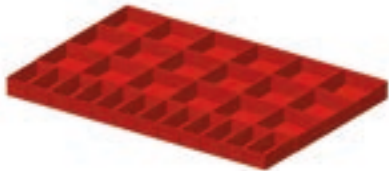

ART.	apto para cajón H mm	componentes	
FFH50050800	50	12 x Caja divisor 150x75 mm 18 x Caja divisor 150x150 mm	
FFH50070800	75		
FFH50100800	100/125		

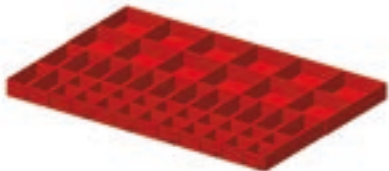

ART.	apto para cajón H mm	componentes	
FFH50051700	50	20 x Caja divisor 75x75 mm 14 x Caja divisor 150x75 mm 12 x Caja divisor 150x150 mm	
FFH50071700	75		

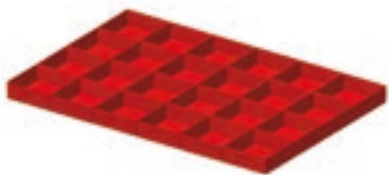

ART.	apto para cajón H mm	componentes	
FFH50051800	50	24 x Caja divisor 150x150 mm	
FFH50071800	75		
FFH50101800	100/125		

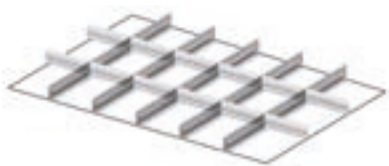

ART.	apto para cajón H mm	componentes	
FFH50051300	50	5 x Separador longitudinal ranurado A=610 mm 12 x Divisor transversal A=151 mm	
FFH50071300	75		
FFH50101300	100/125		
FFH50151300	150/175		
FFH50201300	200/250		
FFH50301300	300		

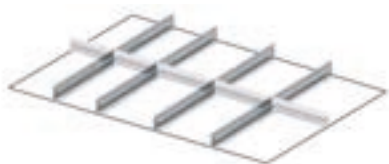

ART.	apto para cajón H mm	componentes	
FFH50050700	50	4 x Separador longitudinal ranurado A=610 mm 2 x Divisor transversal A=151 mm 3 x Divisor transversal A=202 mm	
FFH50070700	75		
FFH50100700	100/125		
FFH50150700	150/175		
FFH50200700	200/250		
FFH50300700	300		



EXTRACCIÓN



CAPACIDAD



RAL 7035 + RAL 7016



RAL 5012



RAL 7035

MASTER DE 54X36 EH

Armario A=1020 mm



ART.	A mm	P mm	H mm	N. par de puertas	N. estante regulable	RAL	
D53A100C0100504	1020	726	1000	1	1	5012	
D53A100C0100508	1020	726	1000	1	1	7035	
D53A100C01005PD	1020	726	1000	1	1	7035+7016	



ART.	A mm	P mm	H mm	N. par de puertas	Material de las puertas	N. estante regulable	RAL	
D53A100C0100604	1020	726	1000	1	Policarbonato	1	5012	
D53A100C0100608	1020	726	1000	1	Policarbonato	1	7035	
D53A100C01006PD	1020	726	1000	1	Policarbonato	1	7035+7016	

MASTER DE ACCESORIOS



Encimera de 3 bordes revestida de PVC

ART.	adaptado para el armario EH	A mm	P mm	H mm	color	
M33T023AG003107	36x36	715	729	23	Negro	
M53T023AG003107	54x36	1021	729	23	Negro	



Top de acero inoxidable

ART.	adaptado para el armario EH	A mm	P mm	H mm		
M33T030MDNX710A	36x36	714	726	31		
M53T030MDNX710A	54x36	1020	726	31		



Top de acero de goma

ART.	adaptado para el armario EH	A mm	P mm	H mm	color	
M33T030MDGM7107	36x36	714	726	32	Negro	
M53T030MDGM7107	54x36	1020	726	32	Negro	



Top de multiplex

ART.	adaptado para el armario EH	A mm	P mm	H mm		
M33T030MU000100	36x36	714	726	30		
M53T030MU000100	54x36	1020	726	30		



Zócalo para carro elevador y transpallet

ART.	adaptado para el armario EH	A mm	P mm	H mm	RAL	
M33Z10010000007	36x36	712	722	100	9005	



Cierre para zócalo

ART.	adaptado para el armario A EH	A mm	P mm	H mm	RAL	
M30Z10011000007	36	708	46	95	9005	



Par de zócalos para carro elevador y transpallet

ART.	adaptado para el armario EH	A mm	P mm	H mm	RAL	
M03Z10020000007	54x36	200	722	100	9005	



Cierre para zócalo

ART.	adaptado para el armario A EH	A mm	P mm	H mm	RAL	
M50Z10021000007	54	1014	46	95	9005	



RAL 7035 + RAL 7016



RAL 5012



RAL 7035



RAL 9005

MASTER

ARMARIOS CON CAJONES SERIE PRO+

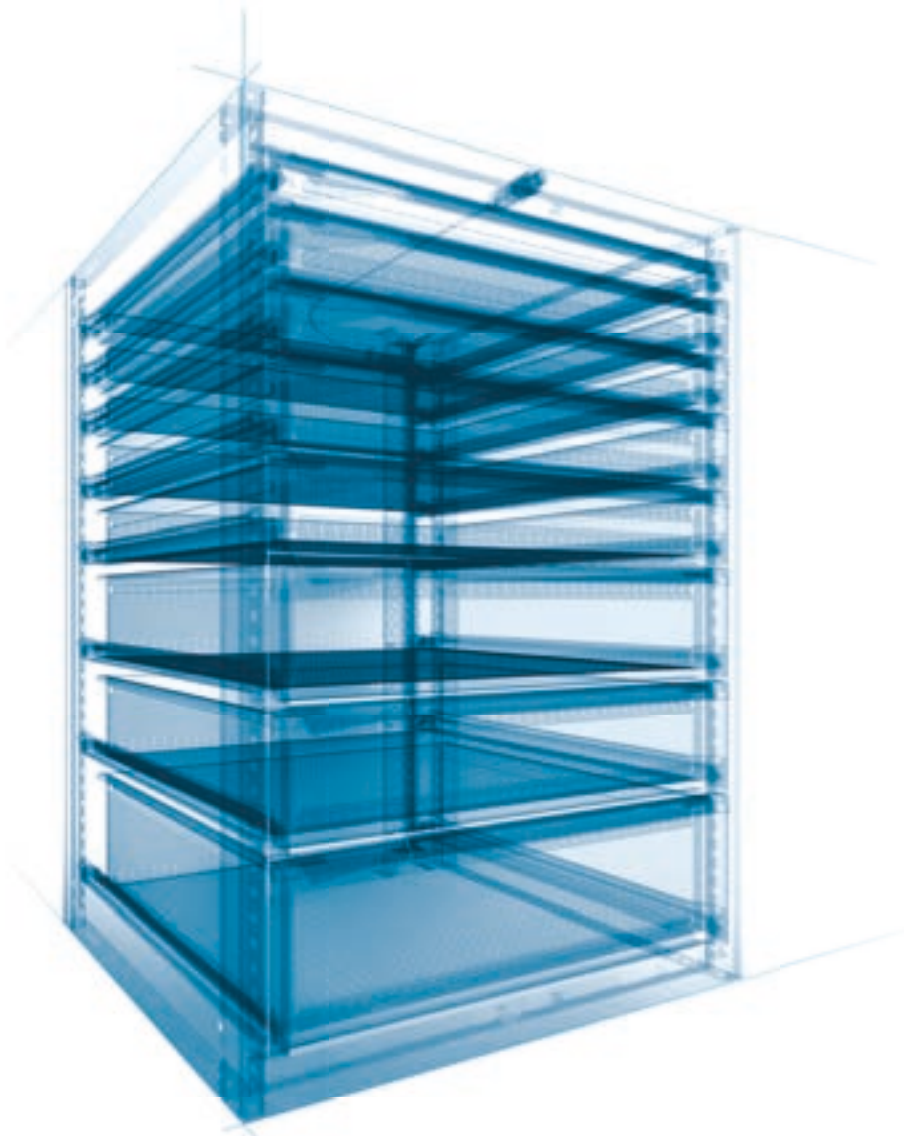

Capacidad de los
cajones de 50 a 200 kg

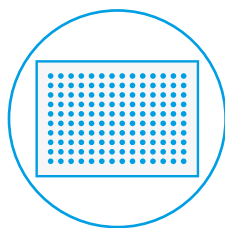

Cajones perforados

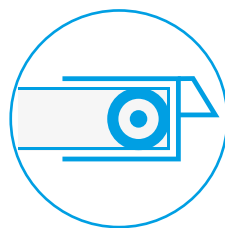

Cojinetes de bolas

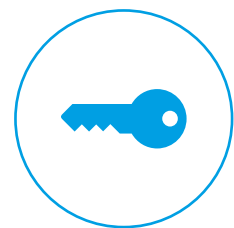

Cierre con llave



VARILLA VERTEBRADA ANTIVUELCO

La varilla es de un perfil de aluminio y se mantiene siempre fija, sin girar.

El movimiento de cierre se obtiene por **cuñas que se desplazan verticalmente** aprovechando una de las fuerzas elementales de la física: **la gravedad. Cuanto más simple es el movimiento, existen menos posibilidades de roturas.**

La varilla está perforada de paso 25 mm y permite la aplicación de más cabezas de cierre. Esto permite dividir el acceso a los cajones en más grupos. La división de los grupos se puede configurar en altura.

SISTEMA MECÁNICO

El sistema de mando mecánico del grupo de cierre utiliza tecnología Sylogik®. **Las diferencias son decisivas.**

El sistema de transmisión desde el cilindro de la cerradura a la cabeza de la varilla se constituye por hilos de acero con funda elástica y movimiento lineal. A diferencia de los sistemas fijos comunes de varilla cuadrada con movimiento giratorio, permite liberar el paralelismo de la posición del cilindro de la cerradura respecto a la cabeza de la varilla. Esto permite al diseñador aplicar el cilindro en el punto más adecuado del armario.

El cilindro de la cerradura se apoya a un tambor de retorno para que pueda elegir distintas casas fabricantes de cilindros*. De este modo el armario puede estar integrado con otros preexistentes manteniendo el mismo tipo de llave.

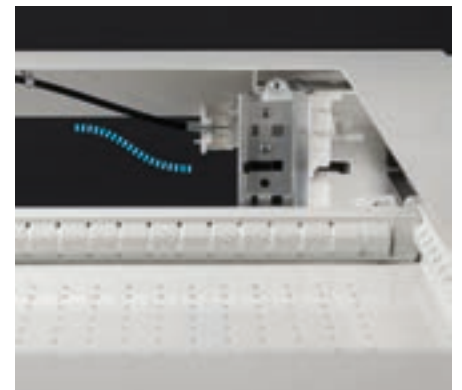

* Opciones por pedido con recargo



EXTRACCIÓN TOTAL



LIBERTAD DE CONFIGURACIÓN
Modifica rápida y fácilmente la extracción del cajón para aumentar la capacidad hasta 100 kg.

GUÍAS DE ALTAS PRESTACIONES



CORRER SIN PROBLEMAS
Las guías de la misma longitud de los cajones permiten desplazar el cojinete en la parte frontal del armario aumentando la visibilidad, la capacidad y la extracción.

CAJONES PERFORADOS



ORGANIZACIÓN AL MILÍMETRO
Los orificios y acanalados en los cajones facilitan la subdivisión interna del cajón, para una perfecta organización de herramientas y materiales.

MASTER

EXTRACCIÓN Y GESTIÓN DEL CAJÓN

El cajón Master representa una revolución en el mundo del mobiliario industrial en cuanto a que fue ideado y desarrollado para ser personalizado de forma autónoma en términos de extracción/capacidad y subdivisión interna.

DE CONFIGURACIÓN LIBRE

La nueva guía de **extracción flexible** permite la regulación mecánica del retén trasero del cajón/estante extraíble, en **3 distintas posiciones** obteniendo así **3 capacidades diferentes: 50, 75, 100 kg**. La instalación de la novedosa **guía telescópica** aumenta la capacidad del **cajón/bandeja extraíble hasta 200 kg**. Una etiqueta indica la capacidad máxima del cajón según su extracción y tipo de guía.

GUÍA FLEXIBLE CONFIGURADA PARA EXTRACCIÓN TOTAL DE 50 KG

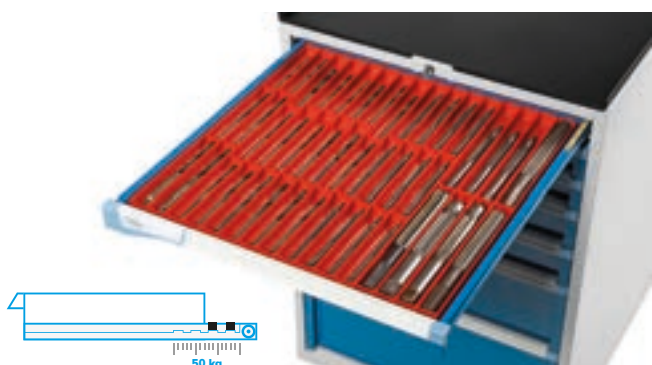

GUÍA FLEXIBLE CONFIGURADA PARA EXTRACCIÓN TOTAL DE 75 KG



GUÍA FLEXIBLE CONFIGURADA PARA EXTRACCIÓN PARCIAL DE 100 KG



GUÍA TELESCÓPICA CONFIGURADA PARA EXTRACCIÓN TOTAL DE 200 KG

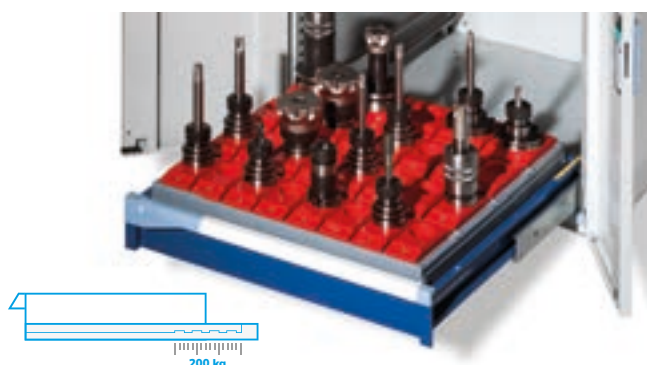

DE ORGANIZACIÓN LIBRE

El cajón puede subdividirse internamente mediante **cajas divisorias portadoras de piezas pequeñas y divisores longitudinales y transversales de metal**.

Estos últimos se fijan con tornillos al fondo perforado del cajón para evitar la salida del material almacenado.



MASTER



Las innovaciones que simplifican la identificación de los contenidos en el interior de los cajones.

Con la tecnología Syfront de Sylogik® el frontal del cajón ya no es más solo un elemento de cierre, se transforma también en una verdadera interfaz visual.

- Personalización con los elementos estéticos y decorativos
- Input usuario: etiquetas para la descripción y catalogación del contenido
- Output usuario: posibilidad de introducir mensajes visuales o descriptivos en la manija

ASAS PERSONALIZABLES

UNA MINA DE INFORMACIÓN
Añade al asa códigos de barras, etiquetas o imágenes para poder conocer rápidamente el contenido de cada cajón.



MODULARIDAD

Los distintos elementos que componen la serie Master pueden ser integrados **fácilmente entre ellos para crear composiciones mobiliarias completas y dispuestas a todo**. De este modo es posible crear, por ejemplo, barras con cajones y puertas de placas de 4 bordes para efectuar mantenimientos y trabajos o para ser utilizados como puestos para el recibimiento de clientes en negocios o depósitos.

Courtesy of Fridle Group



MASTER



TOP DE ACERO INOX SATINADO

El top de acero inoxidable satinado permite realizar trabajos e intervenciones sin dañar el armario. Presenta un elevado nivel de resistencia a la corrosión y al calor.



TOP DE MULTIPLEX

El top en multiplex transforma la parte superior del armario en una superficie de trabajo sólida y robusta. Resiste a golpes y rasguños y se adapta a operaciones pesadas.



TOP DE ACERO DE GOMA

El top está hecho en acero galvanizado y está revestido con goma antiaceite. Está indicado particularmente en caso de uso de aceites o para intervenciones que impliquen el uso de instrumentos de corte.



ENCIMERA DE 3 BORDES REVESTIDA DE PVC

El top de 3 bordes revestido en PVC protege la parte superior del armario y, gracias a los bordes elevados, evita la caída del material en él colocado.

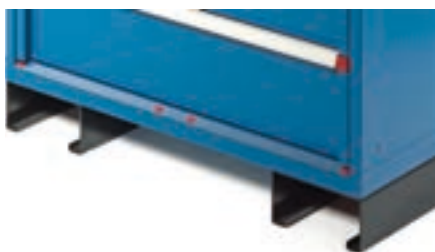

ZÓCALOS

Los zócalos tienen una doble función: elevan el armario a cajones desde el suelo y permiten su movimiento mediante carros elevadores o transpaleta.



RUEDAS

Los armarios pueden estar equipados con ruedas para transformarlos en prácticos carros porta herramientas. De serie están equipados con 2 ruedas giratorias con freno y 2 ruedas fijas.



SISTEMA ANTI-ELUSIÓN

LA SEGURIDAD ES LO PRIMERO
A diferencia de otros armarios existentes en el mercado, el sistema de cierre patentado no permite al ladrón eludir el cierre. En caso de apertura forzada, la violación siempre resulta visible.



MANIJA ERGONÓMICA REGULABLE

Los armarios con ruedas están equipados con una manija ergonómica regulable práctica que puede instalarse en dos posiciones distintas. Por lo tanto, la altura de la manija se podrá ajustar según la altura misma del usuario y para permitir un desplazamiento ágil y fácil del armario, además del mantenimiento de una postura ergonómica con el fin de reducir los esfuerzos durante el trabajo que podría llevar a eventuales accidentes.



MASTER

COLORES

El armario Master está disponible en 12 combinaciones de color al cual es posible asociar 8 colores distintos para las manijas y crear soluciones personalizadas en el mínimo detalles. Por lo tanto, es posible asignar a áreas particulares de trabajo o proyectos colores específicos, o bien implementar el color empresarial incluso en el mobiliario instalado en la empresa.

10 colores RAL para la parte metálica
8 colores para los accesorios de plástico
Infinitas combinaciones

ASA FRONTAL



Dark Grey



Mediterranean Blue



Sky Blue



Glamour Red



Red Carpet



Juicy Orange



Sunny Yellow



Forest Green

ARMARIO



7016
7035



7035



5012



9002



7016



7000



5019



9010



6011



3003



5010



5012
7035

NOTA

EH		18X27 EH	27X27 EH	36X27 EH	54X27 EH	27X36 EH	36X36 EH	45X36 EH	54X36 EH	64X36 EH	78X36 EH	
	Dimensiones armario	A=	408	561	714	1020	561	714	867	1020	1190	1428
		P=	573	573	573	573	726	726	726	726	726	726
	Dimensiones internas cajón	A=	296	449	602	908	449	602	755	908	1078	1316
		P=	449	449	449	449	602	602	602	602	602	602

PE
Estante de extracción flexible



PE
Estante de extracción telescópica



PR
Estante regulable



PF
Estante regulable ranurado





Armario con 3 cajones 1x50 1x100 1x150

ART.	cajones		RAL
M12A040C01001PD	100-75-50	92-96-100%	7035+7016
M12A040C0100108	100-75-50	92-96-100%	7035
M12A040C0100104	100-75-50	92-96-100%	5012

H=400 mm



Armario con 3 cajones 2x75 1x150

ART.	cajones		RAL
M12A040C01002PD	100-75-50	92-96-100%	7035+7016
M12A040C0100208	100-75-50	92-96-100%	7035
M12A040C0100204	100-75-50	92-96-100%	5012

H=400 mm



Armario con 4 cajones 1x50 2x75 1x100

ART.	cajones		RAL
M12A040C01003PD	100-75-50	92-96-100%	7035+7016
M12A040C0100308	100-75-50	92-96-100%	7035
M12A040C0100304	100-75-50	92-96-100%	5012

H=400 mm



Armario con 4 cajones 2x75 1x150 1x200

ART.	cajones		RAL
M12A060C01020PD	100-75-50	92-96-100%	7035+7016
M12A060C0102008	100-75-50	92-96-100%	7035
M12A060C0102004	100-75-50	92-96-100%	5012

H=600 mm



Armario con 3 cajones 1x100 1x200 1x300

ART.	cajones		RAL
M12A070C01029PD	100-75-50	92-96-100%	7035+7016
M12A070C0102908	100-75-50	92-96-100%	7035
M12A070C0102904	100-75-50	92-96-100%	5012

H=700 mm



Armario con 5 cajones 2x75 3x150

ART.	cajones		RAL
M12A070C01035PD	100-75-50	92-96-100%	7035+7016
M12A070C0103508	100-75-50	92-96-100%	7035
M12A070C0103504	100-75-50	92-96-100%	5012

H=700 mm



Armario con ruedas con 4 cajones 2x75 1x150 1x200

ART.	cajones		RAL
M12R060C01020PD	100-75-50	92-96-100%	7035+7016
M12R060C0102008	100-75-50	92-96-100%	7035
M12R060C0102004	100-75-50	92-96-100%	5012

H=822 mm

Ruedas: Goma standard Ø 125 mm
Capacidad del armario: 300 kg



Armario con ruedas con 5 cajones 1x50 2x75 1x100 1x200

ART.	cajones		RAL
M12R060C01021PD	100-75-50	92-96-100%	7035+7016
M12R060C0102108	100-75-50	92-96-100%	7035
M12R060C0102104	100-75-50	92-96-100%	5012

H=822 mm

Ruedas: Goma standard Ø 125 mm
Capacidad del armario: 300 kg



Armario con ruedas con 6 cajones 2x50 2x75 1x150 1x200

ART.	cajones		RAL
M12R070C010SSPD	100-75-50	92-96-100%	7035+7016
M12R070C010SS08	100-75-50	92-96-100%	7035
M12R070C010SS04	100-75-50	92-96-100%	5012

H=922 mm

Ruedas: Goma standard Ø 125 mm
Capacidad del armario: 300 kg



DIM. INTERNAS A x P



EXTRACCIÓN



CAPACIDAD



RAL 7035 + RAL 7016



RAL 5012



RAL 7035



Armario con 2 cajones 1x100 1x200

ART.	cajones		RAL
M22A040C01004PD	100-75-50	92-96-100%	7035+7016
M22A040C0100408	100-75-50	92-96-100%	7035
M22A040C0100404	100-75-50	92-96-100%	5012

H=400 mm



Armario con 3 cajones 1x50 1x100 1x150

ART.	cajones		RAL
M22A040C01001PD	100-75-50	92-96-100%	7035+7016
M22A040C0100108	100-75-50	92-96-100%	7035
M22A040C0100104	100-75-50	92-96-100%	5012

H=400 mm



Armario con 4 cajones 1x50 2x75 1x100

ART.	cajones		RAL
M22A040C01003PD	100-75-50	92-96-100%	7035+7016
M22A040C0100308	100-75-50	92-96-100%	7035
M22A040C0100304	100-75-50	92-96-100%	5012

H=400 mm



Armario con 6 cajones 1x50 2x75 2x100 1x200

ART.	cajones		RAL
M22A070C01032PD	100-75-50	92-96-100%	7035+7016
M22A070C0103208	100-75-50	92-96-100%	7035
M22A070C0103204	100-75-50	92-96-100%	5012

H=700 mm



Armario con 4 cajones 2x100 1x200 1x300

ART.	cajones		RAL
M22A080C01055PD	100-75-50	92-96-100%	7035+7016
M22A080C0105508	100-75-50	92-96-100%	7035
M22A080C0105504	100-75-50	92-96-100%	5012

H=800 mm



Armario con 5 cajones 1x50 2x100 1x150 1x300

ART.	cajones		RAL
M22A080C01054PD	100-75-50	92-96-100%	7035+7016
M22A080C0105408	100-75-50	92-96-100%	7035
M22A080C0105404	100-75-50	92-96-100%	5012

H=800 mm



Armario con 4 cajones 1x100 1x150 1x200 1x300

ART.	cajones		RAL
M22A085C01092PD	100-75-50	92-96-100%	7035+7016
M22A085C0109208	100-75-50	92-96-100%	7035
M22A085C0109204	100-75-50	92-96-100%	5012

H=850 mm



Armario con 5 cajones 1x100 3x150 1x200

ART.	cajones		RAL
M22A085C01088PD	100-75-50	92-96-100%	7035+7016
M22A085C0108808	100-75-50	92-96-100%	7035
M22A085C0108804	100-75-50	92-96-100%	5012

H=850 mm



Armario con 6 cajones 2x75 2x100 2x200

ART.	cajones		RAL
M22A085C01089PD	100-75-50	92-96-100%	7035+7016
M22A085C0108908	100-75-50	92-96-100%	7035
M22A085C0108904	100-75-50	92-96-100%	5012

H=850 mm



Armario con 6 cajones 1x50 2x100 2x150 1x200

ART.	cajones		RAL
M22A085C01091PD	100-75-50	92-96-100%	7035+7016
M22A085C0109108	100-75-50	92-96-100%	7035
M22A085C0109104	100-75-50	92-96-100%	5012

H=850 mm



DIM. INTERNAS A x P



EXTRACCIÓN



CAPACIDAD



RAL 7035 + RAL 7016



RAL 5012



RAL 7035



Armario con 7 cajones 2x75 3x100 2x150

ART.	cajones		RAL
M22A085C01095PD	100-75-50	92-96-100%	7035+7016
M22A085C0109508	100-75-50	92-96-100%	7035
M22A085C0109504	100-75-50	92-96-100%	5012

H=850 mm



Armario con 8 cajones 1x50 2x75 4x100 1x150

ART.	cajones		RAL
M22A085C01087PD	100-75-50	92-96-100%	7035+7016
M22A085C0108708	100-75-50	92-96-100%	7035
M22A085C0108704	100-75-50	92-96-100%	5012

H=850 mm



Armario con ruedas con 4 cajones 2x75 1x150 1x200

ART.	cajones		RAL
M22R060C01020PD	100-75-50	92-96-100%	7035+7016
M22R060C0102008	100-75-50	92-96-100%	7035
M22R060C0102004	100-75-50	92-96-100%	5012

H=822 mm

Ruedas: Goma standard Ø 125 mm
Capacidad del armario: 300 kg



Armario con ruedas con 5 cajones 1x50 2x75 1x100 1x200

ART.	cajones		RAL
M22R060C01021PD	100-75-50	92-96-100%	7035+7016
M22R060C0102108	100-75-50	92-96-100%	7035
M22R060C0102104	100-75-50	92-96-100%	5012

H=822 mm

Ruedas: Goma standard Ø 125 mm
Capacidad del armario: 300 kg



Armario con ruedas con 6 cajones 2x50 2x75 1x150 1x200

ART.	cajones		RAL
M22R070C010SSPD	100-75-50	92-96-100%	7035+7016
M22R070C010SS08	100-75-50	92-96-100%	7035
M22R070C010SS04	100-75-50	92-96-100%	5012

H=922 mm

Ruedas: Goma standard Ø 125 mm
Capacidad del armario: 300 kg



Armario con ruedas con 5 cajones 4x100 1x200

ART.	cajones		RAL
M22R070C010GFDP	100-75-50	92-96-100%	7035+7016
M22R070C010GF08	100-75-50	92-96-100%	7035
M22R070C010GF04	100-75-50	92-96-100%	5012

H=922 mm

Ruedas: Goma standard Ø 125 mm
Capacidad del armario: 300 kg



Armario con ruedas con 6 cajones 1x50 2x75 2x100 1x200

ART.	cajones		RAL
M22R070C01032PD	100-75-50	92-96-100%	7035+7016
M22R070C0103208	100-75-50	92-96-100%	7035
M22R070C0103204	100-75-50	92-96-100%	5012

H=922 mm

Ruedas: Goma standard Ø 125 mm
Capacidad del armario: 300 kg



Armario con ruedas con 6 cajones 2x75 3x100 1x150

ART.	cajones		RAL
M22R070C01044PD	100-75-50	92-96-100%	7035+7016
M22R070C0104408	100-75-50	92-96-100%	7035
M22R070C0104404	100-75-50	92-96-100%	5012

H=922 mm

Ruedas: Goma standard Ø 125 mm
Capacidad del armario: 300 kg



DIM. INTERNAS A x P



EXTRACCIÓN



CAPACIDAD



RAL 7035 + RAL 7016



RAL 5012



RAL 7035



Armario con 5 cajones 1x50 2x100 1x150 1x200

ART.	cajones		RAL
M32A070C01040PD	100-75-50	92-96-100%	7035+7016
M32A070C0104008	100-75-50	92-96-100%	7035
M32A070C0104004	100-75-50	92-96-100%	5012

H=700 mm



Armario con 5 cajones 2x75 2x100 1x250

ART.	cajones		RAL
M32A070C01042PD	100-75-50	92-96-100%	7035+7016
M32A070C0104208	100-75-50	92-96-100%	7035
M32A070C0104204	100-75-50	92-96-100%	5012

H=700 mm



Armario con 6 cajones 2x75 3x100 1x150

ART.	cajones		RAL
M32A070C01044PD	100-75-50	92-96-100%	7035+7016
M32A070C0104408	100-75-50	92-96-100%	7035
M32A070C0104404	100-75-50	92-96-100%	5012

H=700 mm



Armario con 7 cajones 1x50 2x75 2x100 1x150 1x200

ART.	cajones		RAL
M32A085C010AEPD	100-75-50	92-96-100%	7035+7016
M32A085C010AE08	100-75-50	92-96-100%	7035
M32A085C010AE04	100-75-50	92-96-100%	5012

H=850 mm



Armario con 7 cajones 2x75 2x100 2x125 1x150

ART.	cajones		RAL
M32A085C010ACPD	100-75-50	92-96-100%	7035+7016
M32A085C010AC08	100-75-50	92-96-100%	7035
M32A085C010AC04	100-75-50	92-96-100%	5012

H=850 mm



Armario con 8 cajones 4x75 3x100 1x150

ART.	cajones		RAL	
M32A085C010AGPD	100-75-50	92-96-100%	7035+7016	
M32A085C010AG08	100-75-50	92-96-100%	7035	
M32A085C010AG04	100-75-50	92-96-100%	5012	

H=850 mm



Armario con 7 cajones 1x50 2x75 2x100 1x200 1x300

ART.	cajones		RAL	
M32A100C010BNPD	100-75-50	92-96-100%	7035+7016	
M32A100C010BN08	100-75-50	92-96-100%	7035	
M32A100C010BN04	100-75-50	92-96-100%	5012	

H=1000 mm



Armario con 7 cajones 2x75 1x100 3x150 1x200

ART.	cajones		RAL	
M32A100C010AWPD	100-75-50	92-96-100%	7035+7016	
M32A100C010AW08	100-75-50	92-96-100%	7035	
M32A100C010AW04	100-75-50	92-96-100%	5012	

H=1000 mm



Armario con 8 cajones 1x50 2x75 3x100 1x150 1x250

ART.	cajones		RAL	
M32A100C010BQPD	100-75-50	92-96-100%	7035+7016	
M32A100C010BQ08	100-75-50	92-96-100%	7035	
M32A100C010BQ04	100-75-50	92-96-100%	5012	

H=1000 mm



DIM. INTERNAS A x P



EXTRACCIÓN



CAPACIDAD



RAL 7035 + RAL 7016



RAL 5012



RAL 7035



Armario con puertas con 1 cajón 1x75 2xPE

ART.	cajones / estantes extraíbles		RAL	
M32A100C010BUPD	100-75-50	92-96-100%	7035+7016	
M32A100C010BU08	100-75-50	92-96-100%	7035	
M32A100C010BU04	100-75-50	92-96-100%	5012	
M32A100C010BVPD	200	100%	7035+7016	
M32A100C010BV08	200	100%	7035	
M32A100C010BV04	200	100%	5012	

H=1022 mm



Armario con puertas con 2 cajones 2x75 1xPE

ART.	cajones / estantes extraíbles		RAL	
M32A100C010BWPD	100-75-50	92-96-100%	7035+7016	
M32A100C010BW08	100-75-50	92-96-100%	7035	
M32A100C010BW04	100-75-50	92-96-100%	5012	
M32A100C010BXPD	200	100%	7035+7016	
M32A100C010BX08	200	100%	7035	
M32A100C010BX04	200	100%	5012	

H=1022 mm



Armario con puertas con 3 cajones 3x75 1xPE

ART.	cajones / estantes extraíbles		RAL	
M32A100C010BYPD	100-75-50	92-96-100%	7035+7016	
M32A100C010BY08	100-75-50	92-96-100%	7035	
M32A100C010BY04	100-75-50	92-96-100%	5012	
M32A100C010BZPD	200	100%	7035+7016	
M32A100C010BZ08	200	100%	7035	
M32A100C010BZ04	200	100%	5012	

H=1022 mm



Armario con puertas con 3 cajones 3x75 2xPE

ART.	cajones / estantes extraíbles		RAL	
M32A100C010CAPD	100-75-50	92-96-100%	7035+7016	
M32A100C010CA08	100-75-50	92-96-100%	7035	
M32A100C010CA04	100-75-50	92-96-100%	5012	
M32A100C010CBPD	200	100%	7035+7016	
M32A100C010CB08	200	100%	7035	
M32A100C010CB04	200	100%	5012	

H=1022 mm



Armario con puertas con 4 cajones 4x75

ART.	cajones		RAL
M32A100C010CCPD	100-75-50	92-96-100%	7035+7016
M32A100C010CC08	100-75-50	92-96-100%	7035
M32A100C010CC04	100-75-50	92-96-100%	5012
M32A100C010CDPD	200	100%	7035+7016
M32A100C010CD08	200	100%	7035
M32A100C010CD04	200	100%	5012

H=1022 mm



Armario con puertas con 5 cajones 5x75

ART.	cajones		RAL
M32A100C010CEPD	100-75-50	92-96-100%	7035+7016
M32A100C010CE08	100-75-50	92-96-100%	7035
M32A100C010CE04	100-75-50	92-96-100%	5012
M32A100C010CFPD	200	100%	7035+7016
M32A100C010CF08	200	100%	7035
M32A100C010CF04	200	100%	5012

H=1022 mm



Armario con puertas correderas con 2 cajones 2x75 6xPE

ART.	cajones / estantes extraíbles		RAL
M32D100C010GWPD	100-75-50	92-96-100%	7035+7016
M32D100C010GW08	100-75-50	92-96-100%	7035
M32D100C010GW04	100-75-50	92-96-100%	5012
M32D100C010GXPD	200	100%	7035+7016
M32D100C010GX08	200	100%	7035
M32D100C010GX04	200	100%	5012

H=1022 mm



Armario con puertas correderas con 4 cajones 4x75 2xPE

ART.	cajones / estantes extraíbles		RAL
M32D100C010GYPD	100-75-50	92-96-100%	7035+7016
M32D100C010GY08	100-75-50	92-96-100%	7035
M32D100C010GY04	100-75-50	92-96-100%	5012
M32D100C010GZPD	200	100%	7035+7016
M32D100C010GZ08	200	100%	7035
M32D100C010GZ04	200	100%	5012

H=1022 mm





Armario con puertas correderas con 6 cajones 6x75 2xPE



ART.	cajones / estantes extraíbles		RAL
M32D100C010HAPD	100-75-50	92-96-100%	7035+7016
M32D100C010HA08	100-75-50	92-96-100%	7035
M32D100C010HA04	100-75-50	92-96-100%	5012
M32D100C010HBPD	200	100%	7035+7016
M32D100C010HB08	200	100%	7035
M32D100C010HB04	200	100%	5012

H=1022 mm

Armario con puertas correderas con 8 cajones 8x75



ART.	cajones		RAL
M32D100C010HNPD	100-75-50	92-96-100%	7035+7016
M32D100C010HN08	100-75-50	92-96-100%	7035
M32D100C010HN04	100-75-50	92-96-100%	5012
M32D100C010HPPD	200	100%	7035+7016
M32D100C010HP08	200	100%	7035
M32D100C010HP04	200	100%	5012

H=1022 mm

Armario con puertas correderas con 4 cajones 4x75 4xPE



ART.	cajones / estantes extraíbles		RAL
M32D100C010HEPD	100-75-50	92-96-100%	7035+7016
M32D100C010HE08	100-75-50	92-96-100%	7035
M32D100C010HE04	100-75-50	92-96-100%	5012
M32D100C010HFDP	200	100%	7035+7016
M32D100C010HF08	200	100%	7035
M32D100C010HF04	200	100%	5012

H=1022 mm

Armario con puertas correderas con 10 cajones 10x75



ART.	cajones		RAL
M32D100C010HJPD	100-75-50	92-96-100%	7035+7016
M32D100C010HJ08	100-75-50	92-96-100%	7035
M32D100C010HJ04	100-75-50	92-96-100%	5012
M32D100C010HKPD	200	100%	7035+7016
M32D100C010HK08	200	100%	7035
M32D100C010HK04	200	100%	5012

H=1022 mm



Armario con 7 cajones 2xPR 2x75 1x100 3x150 1x200

ART.	cajones		RAL	
M32A200C010FSPD	100-75-50	92-96-100%	7035+7016	
M32A200C010FS08	100-75-50	92-96-100%	7035	
M32A200C010FS04	100-75-50	92-96-100%	5012	
M32A200C010FTPD	200	100%	7035+7016	
M32A200C010FT08	200	100%	7035	
M32A200C010FT04	200	100%	5012	

H=2000 mm



Armario con puertas con 3 cajones 2xPR 2x100 1x150 2xPE

ART.	cajones / estantes extraíbles		RAL	
M32A200C010FWPD	100-75-50	92-96-100%	7035+7016	
M32A200C010FW08	100-75-50	92-96-100%	7035	
M32A200C010FW04	100-75-50	92-96-100%	5012	
M32A200C010FXPD	200	100%	7035+7016	
M32A200C010FX08	200	100%	7035	
M32A200C010FX04	200	100%	5012	

H=2000 mm



Armario con puertas con 7 cajones 3xPR 2x75 1x100 3x150 1x200

ART.	cajones		RAL	
M32A200C010FYPD	100-75-50	92-96-100%	7035+7016	
M32A200C010FY08	100-75-50	92-96-100%	7035	
M32A200C010FY04	100-75-50	92-96-100%	5012	
M32A200C010FZPD	200	100%	7035+7016	
M32A200C010FZ08	200	100%	7035	
M32A200C010FZ04	200	100%	5012	

H=2000 mm





Armario con ruedas con 5 cajones 1x50 2x100 1x150 1x200

ART.	cajones		RAL
M32R070C01040PD	100-75-50	92-96-100%	7035+7016
M32R070C0104008	100-75-50	92-96-100%	7035
M32R070C0104004	100-75-50	92-96-100%	5012

H=922 mm

Ruedas: Goma standard Ø 125 mm
Capacidad del armario: 300 kg



Armario con ruedas con 5 cajones 2x75 2x100 1x250

ART.	cajones		RAL
M32R070C01042PD	100-75-50	92-96-100%	7035+7016
M32R070C0104208	100-75-50	92-96-100%	7035
M32R070C0104204	100-75-50	92-96-100%	5012

H=922 mm

Ruedas: Goma standard Ø 125 mm
Capacidad del armario: 300 kg



Armario con ruedas con 6 cajones 2x75 3x100 1x150

ART.	cajones		RAL
M32R070C01044PD	100-75-50	92-96-100%	7035+7016
M32R070C0104408	100-75-50	92-96-100%	7035
M32R070C0104404	100-75-50	92-96-100%	5012

H=922 mm

Ruedas: Goma standard Ø 125 mm
Capacidad del armario: 300 kg



Cajón H 50 mm

Set compuesto por 12 divisores de 4 canales y 65 divisores transversales de 36 mm



Cajón H 75 mm

Set de predisposición para termoformados



Cajón H 200 mm

Set compuesto por 2 separadores longitudinales ranurados de 455 mm y 3 divisores transversales de 200 mm



Cajón H 300 mm

Set compuesto por 1 separador longitudinal ranurado de 455 mm

Herramientas y termoformados no incluidos



DIM. INTERNAS x P



EXTRACCIÓN



CAPACIDAD



RAL 7035 + RAL 7016



RAL 5012



RAL 7035



Armario con 5 cajones 3x100 1x150 1x300



ART.	cajones		RAL	
M52A085C010AKPD	100-75-50	92-96-100%	7035+7016	
M52A085C010AK08	100-75-50	92-96-100%	7035	
M52A085C010AK04	100-75-50	92-96-100%	5012	
M52A085C010ALPD	200	100%	7035+7016	
M52A085C010AL08	200	100%	7035	
M52A085C010AL04	200	100%	5012	

H=850 mm

Armario con 6 cajones 2x75 2x100 1x150 1x250



ART.	cajones		RAL	
M52A085C010AMPD	100-75-50	92-96-100%	7035+7016	
M52A085C010AM08	100-75-50	92-96-100%	7035	
M52A085C010AM04	100-75-50	92-96-100%	5012	
M52A085C010ANPD	200	100%	7035+7016	
M52A085C010AN08	200	100%	7035	
M52A085C010AN04	200	100%	5012	

H=850 mm

Armario con 7 cajones 1x50 2x75 2x100 1x150 1x200



ART.	cajones		RAL	
M52A085C010AEPD	100-75-50	92-96-100%	7035+7016	
M52A085C010AE08	100-75-50	92-96-100%	7035	
M52A085C010AE04	100-75-50	92-96-100%	5012	
M52A085C010AFPDP	200	100%	7035+7016	
M52A085C010AF08	200	100%	7035	
M52A085C010AF04	200	100%	5012	

H=850 mm Los cajones H=50 mm siempre tienen extracción flexible

Armario con 6 cajones 3x100 2x150 1x300



ART.	cajones		RAL	
M52A100C010CQPD	100-75-50	92-96-100%	7035+7016	
M52A100C010CQ08	100-75-50	92-96-100%	7035	
M52A100C010CQ04	100-75-50	92-96-100%	5012	
M52A100C010CRPD	200	100%	7035+7016	
M52A100C010CR08	200	100%	7035	
M52A100C010CR04	200	100%	5012	

H=1000 mm



Armario con 7 cajones 2x75 1x100 3x150 1x200

ART.	cajones		RAL
M52A100C010AWPD	100-75-50	92-96-100%	7035+7016
M52A100C010AW08	100-75-50	92-96-100%	7035
M52A100C010AW04	100-75-50	92-96-100%	5012
M52A100C010BHPD	200	100%	7035+7016
M52A100C010BH08	200	100%	7035
M52A100C010BH04	200	100%	5012

H=1000 mm



Armario con 8 cajones 2x75 4x100 1x150 1x200

ART.	cajones		RAL
M52A100C010CNPD	100-75-50	92-96-100%	7035+7016
M52A100C010CN08	100-75-50	92-96-100%	7035
M52A100C010CN04	100-75-50	92-96-100%	5012
M52A100C010CPPD	200	100%	7035+7016
M52A100C010CP08	200	100%	7035
M52A100C010CP04	200	100%	5012

H=1000 mm



Armario con 9 cajones 2x75 2x100 1x150 3x200 1x300

ART.	cajones		RAL
M52A150C010FLPD	100-75-50	92-96-100%	7035+7016
M52A150C010FL08	100-75-50	92-96-100%	7035
M52A150C010FL04	100-75-50	92-96-100%	5012
M52A150C010FMPD	200	100%	7035+7016
M52A150C010FM08	200	100%	7035
M52A150C010FM04	200	100%	5012

H=1500 mm



Armario con 10 cajones 2x75 3x100 1x150 4x200

ART.	cajones		RAL
M52A150C010FNPD	100-75-50	92-96-100%	7035+7016
M52A150C010FN08	100-75-50	92-96-100%	7035
M52A150C010FN04	100-75-50	92-96-100%	5012
M52A150C010FPPD	200	100%	7035+7016
M52A150C010FP08	200	100%	7035
M52A150C010FP04	200	100%	5012

H=1500 mm





Armario con 11 cajones 2x75 4x100 3x150 2x200

ART.	cajones		RAL
M52A150C010FQPD	100-75-50	92-96-100%	7035+7016
M52A150C010FQ08	100-75-50	92-96-100%	7035
M52A150C010FQ04	100-75-50	92-96-100%	5012
M52A150C010FRPD	200	100%	7035+7016
M52A150C010FR08	200	100%	7035
M52A150C010FR04	200	100%	5012

H=1500 mm



Armario con 7 cajones 2xPR 2x75 1x100 3x150 1x200

ART.	cajones		RAL
M52A200C010FSPD	100-75-50	92-96-100%	7035+7016
M52A200C010FS08	100-75-50	92-96-100%	7035
M52A200C010FS04	100-75-50	92-96-100%	5012
M52A200C010FTPD	200	100%	7035+7016
M52A200C010FT08	200	100%	7035
M52A200C010FT04	200	100%	5012

H=2000 mm



Armario con puertas con 3 cajones 2xPR 2x100 1x150 2xPE

ART.	cajones / estantes extraíbles		RAL
M52A200C010FWPD	100-75-50	92-96-100%	7035+7016
M52A200C010FW08	100-75-50	92-96-100%	7035
M52A200C010FW04	100-75-50	92-96-100%	5012
M52A200C010FXPD	200	100%	7035+7016
M52A200C010FX08	200	100%	7035
M52A200C010FX04	200	100%	5012

H=2000 mm



Armario con puertas con 7 cajones 3xPR 2x75 1x100 3x150 1x200

ART.	cajones		RAL
M52A200C010FYPD	100-75-50	92-96-100%	7035+7016
M52A200C010FY08	100-75-50	92-96-100%	7035
M52A200C010FY04	100-75-50	92-96-100%	5012
M52A200C010FZPD	200	100%	7035+7016
M52A200C010FZ08	200	100%	7035
M52A200C010FZ04	200	100%	5012

H=2000 mm



Armario con ruedas con 4 cajones 1x100 2x150 1x200

ART.	cajones		RAL
M52R070C01049PD	100-75-50	92-96-100%	7035+7016
M52R070C0104908	100-75-50	92-96-100%	7035
M52R070C0104904	100-75-50	92-96-100%	5012

H=922 mm

Ruedas: Goma elástica Ø 125 mm
Capacidad del armario: 750 kg



Armario con ruedas con 5 cajones 2x75 1x100 1x150 1x200

ART.	cajones		RAL
M52R070C01031PD	100-75-50	92-96-100%	7035+7016
M52R070C0103108	100-75-50	92-96-100%	7035
M52R070C0103104	100-75-50	92-96-100%	5012

H=922 mm

Ruedas: Goma elástica Ø 125 mm
Capacidad del armario: 750 kg



Armario con ruedas con 6 cajones 2x75 3x100 1x150

ART.	cajones		RAL
M52R070C01044PD	100-75-50	92-96-100%	7035+7016
M52R070C0104408	100-75-50	92-96-100%	7035
M52R070C0104404	100-75-50	92-96-100%	5012

H=922 mm

Ruedas: Goma elástica Ø 125 mm
Capacidad del armario: 750 kg





Armario con 1 cajón 1x100

ART.	cajones		RAL
M23A020C01005PD	100-75-50	92-96-100%	7035+7016
M23A020C0100508	100-75-50	92-96-100%	7035
M23A020C0100504	100-75-50	92-96-100%	5012

H=200 mm



Armario con 1 cajón 1x200

ART.	cajones		RAL
M23A030C01006PD	100-75-50	92-96-100%	7035+7016
M23A030C0100608	100-75-50	92-96-100%	7035
M23A030C0100604	100-75-50	92-96-100%	5012

H=300 mm



Armario con 3 cajones 1x50 1x100 1x150

ART.	cajones		RAL
M23A040C01001PD	100-75-50	92-96-100%	7035+7016
M23A040C0100108	100-75-50	92-96-100%	7035
M23A040C0100104	100-75-50	92-96-100%	5012

H=400 mm



Armario con 3 cajones 2x75 1x150

ART.	cajones		RAL
M23A040C01002PD	100-75-50	92-96-100%	7035+7016
M23A040C0100208	100-75-50	92-96-100%	7035
M23A040C0100204	100-75-50	92-96-100%	5012

H=400 mm



Armario con 4 cajones 2x75 1x150 1x200

ART.	cajones		RAL
M23A060C01020PD	100-75-50	92-96-100%	7035+7016
M23A060C0102008	100-75-50	92-96-100%	7035
M23A060C0102004	100-75-50	92-96-100%	5012

H=600 mm



Armario con 5 cajones 1x50 2x75 1x100 1x200

ART.	cajones		RAL	
M23A060C01021PD	100-75-50	92-96-100%	7035+7016	
M23A060C0102108	100-75-50	92-96-100%	7035	
M23A060C0102104	100-75-50	92-96-100%	5012	

H=600 mm



Armario con 5 cajones 2x75 1x100 1x150 1x200

ART.	cajones		RAL	
M23A070C01031PD	100-75-50	92-96-100%	7035+7016	
M23A070C0103108	100-75-50	92-96-100%	7035	
M23A070C0103104	100-75-50	92-96-100%	5012	

H=700 mm



Armario con 4 cajones 1x100 2x150 1x200

ART.	cajones		RAL	
M23A070C01049PD	100-75-50	92-96-100%	7035+7016	
M23A070C0104908	100-75-50	92-96-100%	7035	
M23A070C0104904	100-75-50	92-96-100%	5012	

H=700 mm



Armario con 6 cajones 1x50 2x75 2x100 1x200

ART.	cajones		RAL	
M23A070C01032PD	100-75-50	92-96-100%	7035+7016	
M23A070C0103208	100-75-50	92-96-100%	7035	
M23A070C0103204	100-75-50	92-96-100%	5012	

H=700 mm



Armario con 4 cajones 2x100 1x200 1x300

ART.	cajones		RAL	
M23A080C01055PD	100-75-50	92-96-100%	7035+7016	
M23A080C0105508	100-75-50	92-96-100%	7035	
M23A080C0105504	100-75-50	92-96-100%	5012	

H=800 mm



DIM. INTERNAS A x P



EXTRACCIÓN



CAPACIDAD



RAL 7035 + RAL 7016



RAL 5012



RAL 7035



Armario con 5 cajones 1x50 2x100 1x150 1x300

ART.	cajones		RAL
M23A080C01054PD	100-75-50	92-96-100%	7035+7016
M23A080C0105408	100-75-50	92-96-100%	7035
M23A080C0105404	100-75-50	92-96-100%	5012

H=800 mm



Armario con 6 cajones 2x75 2x100 1x150 1x200

ART.	cajones		RAL
M23A080C01056PD	100-75-50	92-96-100%	7035+7016
M23A080C0105608	100-75-50	92-96-100%	7035
M23A080C0105604	100-75-50	92-96-100%	5012

H=800 mm



Armario con 7 cajones 1x50 2x75 2x100 2x150

ART.	cajones		RAL
M23A080C01066PD	100-75-50	92-96-100%	7035+7016
M23A080C0106608	100-75-50	92-96-100%	7035
M23A080C0106604	100-75-50	92-96-100%	5012

H=800 mm



Armario con 7 cajones 2x75 4x100 1x150

ART.	cajones		RAL
M23A080C01065PD	100-75-50	92-96-100%	7035+7016
M23A080C0106508	100-75-50	92-96-100%	7035
M23A080C0106504	100-75-50	92-96-100%	5012

H=800 mm



Armario con puerta con 1 cajón 1x75 1xPR 1xPE

ART.	cajones / estantes extraíbles		RAL
M23A080C01069PD	100-75-50	92-96-100%	7035+7016
M23A080C0106908	100-75-50	92-96-100%	7035
M23A080C0106904	100-75-50	92-96-100%	5012

H=800 mm



Armario con 4 cajones 3x150 1x300

ART.	cajones		RAL	
M23A085C010AQPDP	100-75-50	92-96-100%	7035+7016	
M23A085C010AQ08	100-75-50	92-96-100%	7035	
M23A085C010AQ04	100-75-50	92-96-100%	5012	

H=850 mm



Armario con 5 cajones 1x50 2x100 1x200 1x300

ART.	cajones		RAL	
M23A085C01093PD	100-75-50	92-96-100%	7035+7016	
M23A085C0109308	100-75-50	92-96-100%	7035	
M23A085C0109304	100-75-50	92-96-100%	5012	

H=850 mm



Armario con 5 cajones 2x100 1x150 2x200

ART.	cajones		RAL	
M23A085C01090PD	100-75-50	92-96-100%	7035+7016	
M23A085C0109008	100-75-50	92-96-100%	7035	
M23A085C0109004	100-75-50	92-96-100%	5012	

H=850 mm



Armario con 6 cajones 1x75 3x100 1x125 1x250

ART.	cajones		RAL	
M23A085C01094PD	100-75-50	92-96-100%	7035+7016	
M23A085C0109408	100-75-50	92-96-100%	7035	
M23A085C0109404	100-75-50	92-96-100%	5012	

H=850 mm



Armario con 6 cajones 1x50 2x100 2x150 1x200

ART.	cajones		RAL	
M23A085C01091PD	100-75-50	92-96-100%	7035+7016	
M23A085C0109108	100-75-50	92-96-100%	7035	
M23A085C0109104	100-75-50	92-96-100%	5012	

H=850 mm





Armario con 7 cajones 1x50 2x75 2x100 1x150 1x200

ART.	cajones		RAL
M23A085C010AEPD	100-75-50	92-96-100%	7035+7016
M23A085C010AE08	100-75-50	92-96-100%	7035
M23A085C010AE04	100-75-50	92-96-100%	5012

H=850 mm



Armario con 7 cajones 2x75 3x100 2x150

ART.	cajones		RAL
M23A085C01095PD	100-75-50	92-96-100%	7035+7016
M23A085C0109508	100-75-50	92-96-100%	7035
M23A085C0109504	100-75-50	92-96-100%	5012

H=850 mm



Armario con 8 cajones 1x50 2x75 4x100 1x150

ART.	cajones		RAL
M23A085C01087PD	100-75-50	92-96-100%	7035+7016
M23A085C0108708	100-75-50	92-96-100%	7035
M23A085C0108704	100-75-50	92-96-100%	5012

H=850 mm



Armario con ruedas con 4 cajones 2x75 1x150 1x200

ART.	cajones		RAL
M23R060C01020PD	100-75-50	92-96-100%	7035+7016
M23R060C0102008	100-75-50	92-96-100%	7035
M23R060C0102004	100-75-50	92-96-100%	5012

H=822 mm

Ruedas: Goma standard Ø 125 mm
Capacidad del armario: 300 kg



Armario con ruedas con 5 cajones 1x50 2x75 1x100 1x200

ART.	cajones		RAL
M23R060C01021PD	100-75-50	92-96-100%	7035+7016
M23R060C0102108	100-75-50	92-96-100%	7035
M23R060C0102104	100-75-50	92-96-100%	5012

H=822 mm

Ruedas: Goma standard Ø 125 mm
Capacidad del armario: 300 kg



Armario con ruedas con 6 cajones 4x75 2x100

ART.	cajones		RAL
M23R060C01022PD	100-75-50	92-96-100%	7035+7016
M23R060C0102208	100-75-50	92-96-100%	7035
M23R060C0102204	100-75-50	92-96-100%	5012

H=822 mm

Ruedas: Goma standard Ø 125 mm
Capacidad del armario: 300 kg



Armario con ruedas con 5 cajones 2x75 1x100 1x150 1x200

ART.	cajones		RAL
M23R070C01031PD	100-75-50	92-96-100%	7035+7016
M23R070C0103108	100-75-50	92-96-100%	7035
M23R070C0103104	100-75-50	92-96-100%	5012

H=922 mm

Ruedas: Goma standard Ø 125 mm
Capacidad del armario: 300 kg



Armario con ruedas con 6 cajones 1x50 2x75 2x100 1x200

ART.	cajones		RAL
M23R070C01032PD	100-75-50	92-96-100%	7035+7016
M23R070C0103208	100-75-50	92-96-100%	7035
M23R070C0103204	100-75-50	92-96-100%	5012

H=922 mm

Ruedas: Goma standard Ø 125 mm
Capacidad del armario: 300 kg



Armario con ruedas con 5 cajones 1x50 2x100 1x150 1x300

ART.	cajones		RAL
M23R080C01054PD	100-75-50	92-96-100%	7035+7016
M23R080C0105408	100-75-50	92-96-100%	7035
M23R080C0105404	100-75-50	92-96-100%	5012

H=1022 mm

Ruedas: Goma standard Ø 125 mm
Capacidad del armario: 300 kg



Armario con ruedas con 5 cajones 3x100 2x200

ART.	cajones		RAL
M23R080C01063PD	100-75-50	92-96-100%	7035+7016
M23R080C0106308	100-75-50	92-96-100%	7035
M23R080C0106304	100-75-50	92-96-100%	5012

H=1022 mm

Ruedas: Goma standard Ø 125 mm
Capacidad del armario: 300 kg



DIM. INTERNAS A x P



EXTRACCIÓN



CAPACIDAD



RAL 7035 + RAL 7016



RAL 5012



RAL 7035



Armario con ruedas con 7 cajones 2x75 4x100 1x150

ART.	cajones		RAL
M23R080C01065PD	100-75-50	92-96-100%	7035+7016
M23R080C0106508	100-75-50	92-96-100%	7035
M23R080C0106504	100-75-50	92-96-100%	5012

H=1022 mm

Ruedas: Goma standard Ø 125 mm
Capacidad del armario: 300 kg



Armario con ruedas con 7 cajones 1x50 2x75 2x100 2x150

ART.	cajones		RAL
M23R080C01066PD	100-75-50	92-96-100%	7035+7016
M23R080C0106608	100-75-50	92-96-100%	7035
M23R080C0106604	100-75-50	92-96-100%	5012

H=1022 mm

Ruedas: Goma standard Ø 125 mm
Capacidad del armario: 300 kg





Herramientas y termoformados no incluidos



Cajón H 50 mm
Set compuesto por 12 divisores de 4 canales y 65 divisores transversales de 36 mm



Cajón H 75 mm
Set de predisposición para termoformados



Cajón H 150 mm
Set compuesto por 2 separadores longitudinales ranurados de 610 mm y 3 divisores transversales de 149 mm



DIM. INTERNAS A x P



EXTRACCIÓN



CAPACIDAD



RAL 7035 + RAL 7016



RAL 5012



RAL 7035



Armario con 4 cajones 1x100 2x150 1x300



ART.	cajones		RAL
M33A080C01072PD	100-75-50	92-96-100%	7035+7016
M33A080C0107208	100-75-50	92-96-100%	7035
M33A080C0107204	100-75-50	92-96-100%	5012

H=800 mm

Armario con 6 cajones 2x75 2x100 1x150 1x200



ART.	cajones		RAL
M33A080C01056PD	100-75-50	92-96-100%	7035+7016
M33A080C0105608	100-75-50	92-96-100%	7035
M33A080C0105604	100-75-50	92-96-100%	5012

H=800 mm

Armario con 4 cajones 1x100 1x150 1x200 1x300



ART.	cajones		RAL
M33A085C01092PD	100-75-50	92-96-100%	7035+7016
M33A085C0109208	100-75-50	92-96-100%	7035
M33A085C0109204	100-75-50	92-96-100%	5012
M33A085C010ASPD	200	100%	7035+7016
M33A085C010AS08	200	100%	7035
M33A085C010AS04	200	100%	5012

H=850 mm

Armario con 5 cajones 1x50 2x100 1x200 1x300



ART.	cajones		RAL
M33A085C01093PD	100-75-50	92-96-100%	7035+7016
M33A085C0109308	100-75-50	92-96-100%	7035
M33A085C0109304	100-75-50	92-96-100%	5012
M33A085C010ATPD	200	100%	7035+7016
M33A085C010AT08	200	100%	7035
M33A085C010AT04	200	100%	5012

H=850 mm Los cajones H=50 mm siempre tienen extracción flexible



Armario con 5 cajones 1x100 3x150 1x200

ART.	cajones		RAL
M33A085C01088PD	100-75-50	92-96-100%	7035+7016
M33A085C0108808	100-75-50	92-96-100%	7035
M33A085C0108804	100-75-50	92-96-100%	5012
M33A085C010APPD	200	100%	7035+7016
M33A085C010AP08	200	100%	7035
M33A085C010AP04	200	100%	5012

H=850 mm



Armario con 7 cajones 1x50 2x75 2x100 1x150 1x200

ART.	cajones		RAL
M33A085C010AEPD	100-75-50	92-96-100%	7035+7016
M33A085C010AE08	100-75-50	92-96-100%	7035
M33A085C010AE04	100-75-50	92-96-100%	5012
M33A085C010AFPD	200	100%	7035+7016
M33A085C010AF08	200	100%	7035
M33A085C010AF04	200	100%	5012

H=850 mm Los cajones H=50 mm siempre tienen extracción flexible



Armario con 7 cajones 2x75 3x100 2x150

ART.	cajones		RAL
M33A085C01095PD	100-75-50	92-96-100%	7035+7016
M33A085C0109508	100-75-50	92-96-100%	7035
M33A085C0109504	100-75-50	92-96-100%	5012
M33A085C010AUPD	200	100%	7035+7016
M33A085C010AU08	200	100%	7035
M33A085C010AU04	200	100%	5012

H=850 mm



Armario con 8 cajones 1x50 2x75 4x100 1x150

ART.	cajones		RAL
M33A085C01087PD	100-75-50	92-96-100%	7035+7016
M33A085C0108708	100-75-50	92-96-100%	7035
M33A085C0108704	100-75-50	92-96-100%	5012
M33A085C010AVPD	200	100%	7035+7016
M33A085C010AV08	200	100%	7035
M33A085C010AV04	200	100%	5012

H=850 mm Los cajones H=50 mm siempre tienen extracción flexible





Armario con 6 cajones 1x50 3x150 2x200



ART.	cajones		RAL
M33A100C010CZPD	100-75-50	92-96-100%	7035+7016
M33A100C010CZ08	100-75-50	92-96-100%	7035
M33A100C010CZ04	100-75-50	92-96-100%	5012
M33A100C010DAPD	200	100%	7035+7016
M33A100C010DA08	200	100%	7035
M33A100C010DA04	200	100%	5012

H=1000 mm Los cajones H=50 mm siempre tienen extracción flexible

Armario con 6 cajones 1x100 4x150 1x200



ART.	cajones		RAL
M33A100C010DBPD	100-75-50	92-96-100%	7035+7016
M33A100C010DB08	100-75-50	92-96-100%	7035
M33A100C010DB04	100-75-50	92-96-100%	5012
M33A100C010DCPD	200	100%	7035+7016
M33A100C010DC08	200	100%	7035
M33A100C010DC04	200	100%	5012

H=1000 mm

Armario con 7 cajones 1x50 2x75 2x100 1x200 1x300



ART.	cajones		RAL
M33A100C010BNPD	100-75-50	92-96-100%	7035+7016
M33A100C010BN08	100-75-50	92-96-100%	7035
M33A100C010BN04	100-75-50	92-96-100%	5012
M33A100C010BPPD	200	100%	7035+7016
M33A100C010BP08	200	100%	7035
M33A100C010BP04	200	100%	5012

H=1000 mm Los cajones H=50 mm siempre tienen extracción flexible

Armario con 7 cajones 2x75 1x100 3x150 1x200



ART.	cajones		RAL
M33A100C010AWPD	100-75-50	92-96-100%	7035+7016
M33A100C010AW08	100-75-50	92-96-100%	7035
M33A100C010AW04	100-75-50	92-96-100%	5012
M33A100C010BHPD	200	100%	7035+7016
M33A100C010BH08	200	100%	7035
M33A100C010BH04	200	100%	5012

H=1000 mm



Armario con 8 cajones 1x50 2x75 2x100 2x150 1x200

ART.	cajones		RAL
M33A100C010CUPD	100-75-50	92-96-100%	7035+7016
M33A100C010CU08	100-75-50	92-96-100%	7035
M33A100C010CU04	100-75-50	92-96-100%	5012
M33A100C010CVPD	200	100%	7035+7016
M33A100C010CV08	200	100%	7035
M33A100C010CV04	200	100%	5012

H=1000 mm Los cajones H=50 mm siempre tienen extracción flexible



Armario con 8 cajones 2x75 3x100 3x150

ART.	cajones		RAL
M33A100C010DDPD	100-75-50	92-96-100%	7035+7016
M33A100C010DD08	100-75-50	92-96-100%	7035
M33A100C010DD04	100-75-50	92-96-100%	5012
M33A100C010DEPD	200	100%	7035+7016
M33A100C010DE08	200	100%	7035
M33A100C010DE04	200	100%	5012

H=1000 mm



Armario con 9 cajones 9x100

ART.	cajones		RAL
M33A100C010BLPD	100-75-50	92-96-100%	7035+7016
M33A100C010BL08	100-75-50	92-96-100%	7035
M33A100C010BL04	100-75-50	92-96-100%	5012
M33A100C010BMPD	200	100%	7035+7016
M33A100C010BM08	200	100%	7035
M33A100C010BM04	200	100%	5012

H=1000 mm



Armario con 10 cajones 1x50 2x75 7x100

ART.	cajones		RAL
M33A100C010DFPD	100-75-50	92-96-100%	7035+7016
M33A100C010DF08	100-75-50	92-96-100%	7035
M33A100C010DF04	100-75-50	92-96-100%	5012
M33A100C010DGPD	200	100%	7035+7016
M33A100C010DG08	200	100%	7035
M33A100C010DG04	200	100%	5012

H=1000 mm Los cajones H=50 mm siempre tienen extracción flexible





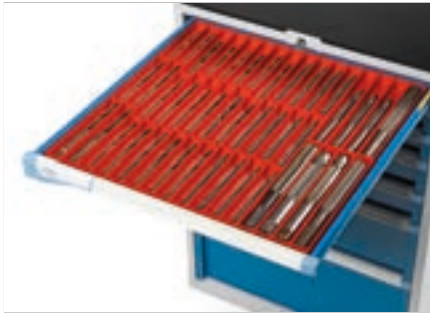

Cajón H 50 mm
Set compuesto por 16 divisores de 4 canales y 65 divisores transversales de 36 mm



Cajón H 75 mm
Set de predisposición para termoformados



Cajón H 75 mm
Set de predisposición para termoformados



Cajón H 100 mm
Set de predisposición para termoformados



Cajón H 100 mm
Set compuesto por 3 separadores longitudinales ranurados de 610 mm y 15 divisores transversales de 149 mm



Cajón H 200 mm
Set compuesto por 2 separadores longitudinales ranurados de 610 mm y 3 divisores transversales de 200 mm



Cajón H 300 mm
Set compuesto por 1 separador longitudinal ranurado de 610 mm



Disponible en varias dimensiones

Herramientas y termoformados no incluidos



Armario con puertas con 2 cajones 2x75 2xPE



ART.	cajones / estantes extraíbles		RAL
M33A100C010LJPD	100-75-50	92-96-100%	7035+7016
M33A100C010LJ08	100-75-50	92-96-100%	7035
M33A100C010LJ04	100-75-50	92-96-100%	5012
M33A100C010LKPDP	200	100%	7035+7016
M33A100C010LK08	200	100%	7035
M33A100C010LK04	200	100%	5012

H=1022 mm

Armario con puertas 2xPR 2xPE



ART.	estantes extraíbles		RAL
M33A100C010LMPD	100-75-50	92-96-100%	7035+7016
M33A100C010LM08	100-75-50	92-96-100%	7035
M33A100C010LM04	100-75-50	92-96-100%	5012
M33A100C010LNPD	200	100%	7035+7016
M33A100C010LN08	200	100%	7035
M33A100C010LN04	200	100%	5012

H=1022 mm

Armario con puertas con 4 cajones 4x75



ART.	cajones		RAL
M33A100C010CCPD	100-75-50	92-96-100%	7035+7016
M33A100C010CC08	100-75-50	92-96-100%	7035
M33A100C010CC04	100-75-50	92-96-100%	5012
M33A100C010CDPD	200	100%	7035+7016
M33A100C010CD08	200	100%	7035
M33A100C010CD04	200	100%	5012

H=1022 mm

Armario con puertas con 3 cajones 1x125 2x75 2xPE



ART.	cajones / estantes extraíbles		RAL
M33A100C010LRPD	100-75-50	92-96-100%	7035+7016
M33A100C010LR08	100-75-50	92-96-100%	7035
M33A100C010LR04	100-75-50	92-96-100%	5012
M33A100C010LSPD	200	100%	7035+7016
M33A100C010LS08	200	100%	7035
M33A100C010LS04	200	100%	5012

H=1022 mm



Armario con puertas con 5 cajones 1x50 2x75 2x100 1xPE

ART.	cajones / estantes extraíbles		RAL
M33A100C010LTPD	100-75-50	92-96-100%	7035+7016
M33A100C010LT08	100-75-50	92-96-100%	7035
M33A100C010LT04	100-75-50	92-96-100%	5012
M33A100C010LUPD	200	100%	7035+7016
M33A100C010LU08	200	100%	7035
M33A100C010LU04	200	100%	5012

H=1022 mm Los cajones H=50 mm siempre tienen extracción flexible



Armario con puertas con 5 cajones 1x50 4x75 1xPE

ART.	cajones / estantes extraíbles		RAL
M33A100C010LVPD	100-75-50	92-96-100%	7035+7016
M33A100C010LV08	100-75-50	92-96-100%	7035
M33A100C010LV04	100-75-50	92-96-100%	5012
M33A100C010LWPD	200	100%	7035+7016
M33A100C010LW08	200	100%	7035
M33A100C010LW04	200	100%	5012

H=1022 mm Los cajones H=50 mm siempre tienen extracción flexible



Armario con puertas correderas con 4 cajones 4x75 2xPE

ART.	cajones / estantes extraíbles		RAL
M33D100C010GYPD	100-75-50	92-96-100%	7035+7016
M33D100C010GY08	100-75-50	92-96-100%	7035
M33D100C010GY04	100-75-50	92-96-100%	5012
M33D100C010GZPD	200	100%	7035+7016
M33D100C010GZ08	200	100%	7035
M33D100C010GZ04	200	100%	5012

H=1022 mm



Armario con puertas correderas 4xPR 2xPE

ART.	estantes extraíbles		RAL
M33D100C010JAPD	100-75-50	92-96-100%	7035+7016
M33D100C010JA08	100-75-50	92-96-100%	7035
M33D100C010JA04	100-75-50	92-96-100%	5012
M33D100C010JBPD	200	100%	7035+7016
M33D100C010JB08	200	100%	7035
M33D100C010JB04	200	100%	5012

H=1022 mm





Armario con puertas correderas con 4 cajones 4x75 4xPE

ART.	cajones / estantes extraíbles		RAL
M33D100C010HEPD	100-75-50	92-96-100%	7035+7016
M33D100C010HE08	100-75-50	92-96-100%	7035
M33D100C010HE04	100-75-50	92-96-100%	5012
M33D100C010HFPD	200	100%	7035+7016
M33D100C010HF08	200	100%	7035
M33D100C010HF04	200	100%	5012

H=1022 mm



Armario con 9 cajones 2x75 2x100 1x150 3x200 1x300

ART.	cajones		RAL
M33A150C010LXPD	100-75-50	92-96-100%	7035+7016
M33A150C010LX08	100-75-50	92-96-100%	7035
M33A150C010LX04	100-75-50	92-96-100%	5012
M33A150C010LYPD	200	100%	7035+7016
M33A150C010LY08	200	100%	7035
M33A150C010LY04	200	100%	5012

H=1500 mm



Armario con 9 cajones 2x100 6x150 1x300

ART.	cajones		RAL
M33A150C010FJPD	100-75-50	92-96-100%	7035+7016
M33A150C010FJ08	100-75-50	92-96-100%	7035
M33A150C010FJ04	100-75-50	92-96-100%	5012
M33A150C010FKPD	200	100%	7035+7016
M33A150C010FK08	200	100%	7035
M33A150C010FK04	200	100%	5012

H=1500 mm



Armario con 10 cajones 1x50 4x100 1x150 4x200

ART.	cajones		RAL
M33A150C010LZPD	100-75-50	92-96-100%	7035+7016
M33A150C010LZ08	100-75-50	92-96-100%	7035
M33A150C010LZ04	100-75-50	92-96-100%	5012
M33A150C010MAPD	200	100%	7035+7016
M33A150C010MA08	200	100%	7035
M33A150C010MA04	200	100%	5012

H=1500 mm Los cajones H=50 mm siempre tienen extracción flexible



Armario con puertas con 3 cajones 2x75 1x150 2xPE

ART.	cajones / estantes extraíbles		RAL
M33A150C010LAPD	100-75-50	92-96-100%	7035+7016
M33A150C010LA08	100-75-50	92-96-100%	7035
M33A150C010LA04	100-75-50	92-96-100%	5012
M33A150C010LBDP	200	100%	7035+7016
M33A150C010LB08	200	100%	7035
M33A150C010LB04	200	100%	5012

H=1500 mm



Armario con puertas 3xPR 2xPE

ART.	estantes extraíbles		RAL
M33A150C010LCPD	100-75-50	92-96-100%	7035+7016
M33A150C010LC08	100-75-50	92-96-100%	7035
M33A150C010LC04	100-75-50	92-96-100%	5012
M33A150C010LDPD	200	100%	7035+7016
M33A150C010LD08	200	100%	7035
M33A150C010LD04	200	100%	5012

H=1500 mm



Armario con puertas con 5 cajones 2x75 3x150

ART.	cajones		RAL
M33A150C010LEPD	100-75-50	92-96-100%	7035+7016
M33A150C010LE08	100-75-50	92-96-100%	7035
M33A150C010LE04	100-75-50	92-96-100%	5012
M33A150C010LFPD	200	100%	7035+7016
M33A150C010LF08	200	100%	7035
M33A150C010LF04	200	100%	5012

H=1500 mm



PE: ESTANTE EXTRAÍBLE
PR: ESTANTE REGULABLE



DIM. INTERNAS A x P



EXTRACCIÓN



CAPACIDAD



RAL 7035 + RAL 7016



RAL 5012



RAL 7035



Armario con 7 cajones 2xPR 2x75 1x100 3x150 1x200

ART.	cajones		RAL
M33A200C010FSPD	100-75-50	92-96-100%	7035+7016
M33A200C010FS08	100-75-50	92-96-100%	7035
M33A200C010FS04	100-75-50	92-96-100%	5012
M33A200C010FTPD	200	100%	7035+7016
M33A200C010FT08	200	100%	7035
M33A200C010FT04	200	100%	5012

H=2000 mm



Armario con puertas con 3 cajones 2xPR 2x100 1x150 2xPE

ART.	cajones / estantes extraíbles		RAL
M33A200C010FWPD	100-75-50	92-96-100%	7035+7016
M33A200C010FW08	100-75-50	92-96-100%	7035
M33A200C010FW04	100-75-50	92-96-100%	5012
M33A200C010FXPD	200	100%	7035+7016
M33A200C010FX08	200	100%	7035
M33A200C010FX04	200	100%	5012

H=2000 mm



Armario con puertas con 7 cajones 3xPR 2x75 1x100 3x150 1x200

ART.	cajones		RAL
M33A200C010FYPD	100-75-50	92-96-100%	7035+7016
M33A200C010FY08	100-75-50	92-96-100%	7035
M33A200C010FY04	100-75-50	92-96-100%	5012
M33A200C010FZPD	200	100%	7035+7016
M33A200C010FZ08	200	100%	7035
M33A200C010FZ04	200	100%	5012

H=2000 mm



Armario con ruedas con 3 cajones 1x100 1x200 1x300

ART.	cajones		RAL
M33R070C01029PD	100-75-50	92-96-100%	7035+7016
M33R070C0102908	100-75-50	92-96-100%	7035
M33R070C0102904	100-75-50	92-96-100%	5012

H=922 mm Ruedas: Goma elástica Ø 125 mm
Capacidad del armario: 750 kg



Armario con ruedas con 5 cajones 1x50 2x100 1x150 1x200

ART.	cajones		RAL
M33R070C01040PD	100-75-50	92-96-100%	7035+7016
M33R070C0104008	100-75-50	92-96-100%	7035
M33R070C0104004	100-75-50	92-96-100%	5012

H=922 mm Ruedas: Goma elástica Ø 125 mm
Capacidad del armario: 750 kg



Armario con ruedas con 6 cajones 2x75 3x100 1x150

ART.	cajones		RAL
M33R070C01044PD	100-75-50	92-96-100%	7035+7016
M33R070C0104408	100-75-50	92-96-100%	7035
M33R070C0104404	100-75-50	92-96-100%	5012

H=922 mm Ruedas: Goma elástica Ø 125 mm
Capacidad del armario: 750 kg



Armario con ruedas con 7 cajones 2x75 2x100 2x125 1x150

ART.	cajones		RAL
M33R085C010ACPD	100-75-50	92-96-100%	7035+7016
M33R085C010AC08	100-75-50	92-96-100%	7035
M33R085C010AC04	100-75-50	92-96-100%	5012

H=1072 mm Ruedas: Goma elástica Ø 125 mm
Capacidad del armario: 750 kg



Armario con ruedas con 8 cajones 4x75 3x100 1x150

ART.	cajones		RAL
M33R085C010AGPD	100-75-50	92-96-100%	7035+7016
M33R085C010AG08	100-75-50	92-96-100%	7035
M33R085C010AG04	100-75-50	92-96-100%	5012

H=1072 mm Ruedas: Goma elástica Ø 125 mm
Capacidad del armario: 750 kg



Armario con 7 cajones 1x50 2x75 2x100 1x150 1x200



ART.	cajones		RAL
M43A085C010AEPD	100-75-50	92-96-100%	7035+7016
M43A085C010AE08	100-75-50	92-96-100%	7035
M43A085C010AE04	100-75-50	92-96-100%	5012
M43A085C010AFPD	200	100%	7035+7016
M43A085C010AF08	200	100%	7035
M43A085C010AF04	200	100%	5012

H=850 mm Los cajones H=50 mm siempre tienen extracción flexible

Armario con 7 cajones 2x75 2x100 2x125 1x150



ART.	cajones		RAL
M43A085C010ACPD	100-75-50	92-96-100%	7035+7016
M43A085C010AC08	100-75-50	92-96-100%	7035
M43A085C010AC04	100-75-50	92-96-100%	5012
M43A085C010ADPD	200	100%	7035+7016
M43A085C010AD08	200	100%	7035
M43A085C010AD04	200	100%	5012

H=850 mm

Armario con 8 cajones 4x75 3x100 1x150



ART.	cajones		RAL
M43A085C010AGPD	100-75-50	92-96-100%	7035+7016
M43A085C010AG08	100-75-50	92-96-100%	7035
M43A085C010AG04	100-75-50	92-96-100%	5012
M43A085C010AHPD	200	100%	7035+7016
M43A085C010AH08	200	100%	7035
M43A085C010AH04	200	100%	5012

H=850 mm

Armario con 7 cajones 1x50 2x75 2x100 1x200 1x300



ART.	cajones		RAL
M43A100C010BNPD	100-75-50	92-96-100%	7035+7016
M43A100C010BN08	100-75-50	92-96-100%	7035
M43A100C010BN04	100-75-50	92-96-100%	5012
M43A100C010BPPD	200	100%	7035+7016
M43A100C010BP08	200	100%	7035
M43A100C010BP04	200	100%	5012

H=1000 mm Los cajones H=50 mm siempre tienen extracción flexible



Armario con 8 cajones 1x50 2x75 3x100 1x150 1x250

ART.	cajones		RAL	
M43A100C010BQPD	100-75-50	92-96-100%	7035+7016	
M43A100C010BQ08	100-75-50	92-96-100%	7035	
M43A100C010BQ04	100-75-50	92-96-100%	5012	
M43A100C010BRPD	200	100%	7035+7016	
M43A100C010BR08	200	100%	7035	
M43A100C010BR04	200	100%	5012	

H=1000 mm Los cajones H=50 mm siempre tienen extracción flexible



Armario con 9 cajones 3x50 2x75 2x100 1x150 1x250

ART.	cajones		RAL	
M43A100C010CSPD	100-75-50	92-96-100%	7035+7016	
M43A100C010CS08	100-75-50	92-96-100%	7035	
M43A100C010CS04	100-75-50	92-96-100%	5012	
M43A100C010CTPD	200	100%	7035+7016	
M43A100C010CT08	200	100%	7035	
M43A100C010CT04	200	100%	5012	

H=1000 mm Los cajones H=50 mm siempre tienen extracción flexible



Armario con 9 cajones 3x100 4x150 1x200 1x300

ART.	cajones		RAL	
M43A150C010FAPD	100-75-50	92-96-100%	7035+7016	
M43A150C010FA08	100-75-50	92-96-100%	7035	
M43A150C010FA04	100-75-50	92-96-100%	5012	
M43A150C010FBPD	200	100%	7035+7016	
M43A150C010FB08	200	100%	7035	
M43A150C010FB04	200	100%	5012	

H=1500 mm



Armario con 9 cajones 8x150 1x200

ART.	cajones		RAL	
M43A150C010EYPD	100-75-50	92-96-100%	7035+7016	
M43A150C010EY08	100-75-50	92-96-100%	7035	
M43A150C010EY04	100-75-50	92-96-100%	5012	
M43A150C010EZPD	200	100%	7035+7016	
M43A150C010EZ08	200	100%	7035	
M43A150C010EZ04	200	100%	5012	

H=1500 mm



DIM. INTERNAS A x P



EXTRACCIÓN



CAPACIDAD



RAL 7035 + RAL 7016



RAL 5012



RAL 7035



Armario con 5 cajones 3x100 1x150 1x300



ART.	cajones		RAL
M53A085C010AKPD	100-75-50	92-96-100%	7035+7016
M53A085C010AK08	100-75-50	92-96-100%	7035
M53A085C010AK04	100-75-50	92-96-100%	5012
M53A085C010ALPD	200	100%	7035+7016
M53A085C010AL08	200	100%	7035
M53A085C010AL04	200	100%	5012

H=850 mm

Armario con 6 cajones 2x75 2x100 1x150 1x250



ART.	cajones		RAL
M53A085C010AMPD	100-75-50	92-96-100%	7035+7016
M53A085C010AM08	100-75-50	92-96-100%	7035
M53A085C010AM04	100-75-50	92-96-100%	5012
M53A085C010ANPD	200	100%	7035+7016
M53A085C010AN08	200	100%	7035
M53A085C010AN04	200	100%	5012

H=850 mm

Armario con 7 cajones 1x50 2x75 2x100 1x150 1x200



ART.	cajones		RAL
M53A085C010AEPD	100-75-50	92-96-100%	7035+7016
M53A085C010AE08	100-75-50	92-96-100%	7035
M53A085C010AE04	100-75-50	92-96-100%	5012
M53A085C010AFPDP	200	100%	7035+7016
M53A085C010AF08	200	100%	7035
M53A085C010AF04	200	100%	5012

H=850 mm Los cajones H=50 mm siempre tienen extracción flexible

Armario con 5 cajones 2x100 2x200 1x300



ART.	cajones		RAL
M53A100C010EAPD	100-75-50	92-96-100%	7035+7016
M53A100C010EA08	100-75-50	92-96-100%	7035
M53A100C010EA04	100-75-50	92-96-100%	5012
M53A100C010EBPD	200	100%	7035+7016
M53A100C010EB08	200	100%	7035
M53A100C010EB04	200	100%	5012

H=1000 mm



Armario con 6 cajones 1x100 4x150 1x200



ART.	cajones		RAL	
	KG			
M53A100C010DBPD	100-75-50	92-96-100%	7035+7016	
M53A100C010DB08	100-75-50	92-96-100%	7035	
M53A100C010DB04	100-75-50	92-96-100%	5012	
M53A100C010DCPD	200	100%	7035+7016	
M53A100C010DC08	200	100%	7035	
M53A100C010DC04	200	100%	5012	

H=1000 mm

Armario con 7 cajones 1x50 2x75 2x100 1x200 1x300



ART.	cajones		RAL	
	KG			
M53A100C010BNPD	100-75-50	92-96-100%	7035+7016	
M53A100C010BN08	100-75-50	92-96-100%	7035	
M53A100C010BN04	100-75-50	92-96-100%	5012	
M53A100C010BPPD	200	100%	7035+7016	
M53A100C010BP08	200	100%	7035	
M53A100C010BP04	200	100%	5012	

H=1000 mm Los cajones H=50 mm siempre tienen extracción flexible

Armario con 7 cajones 2x75 1x100 3x150 1x200



ART.	cajones		RAL	
	KG			
M53A100C010AWPD	100-75-50	92-96-100%	7035+7016	
M53A100C010AW08	100-75-50	92-96-100%	7035	
M53A100C010AW04	100-75-50	92-96-100%	5012	
M53A100C010BHPD	200	100%	7035+7016	
M53A100C010BH08	200	100%	7035	
M53A100C010BH04	200	100%	5012	

H=1000 mm

Armario con 8 cajones 1x50 2x75 2x100 2x150 1x200



ART.	cajones		RAL	
	KG			
M53A100C010CUPD	100-75-50	92-96-100%	7035+7016	
M53A100C010CU08	100-75-50	92-96-100%	7035	
M53A100C010CU04	100-75-50	92-96-100%	5012	
M53A100C010CVPD	200	100%	7035+7016	
M53A100C010CV08	200	100%	7035	
M53A100C010CV04	200	100%	5012	

H=1000 mm Los cajones H=50 mm siempre tienen extracción flexible



DIM. INTERNAS A x P



EXTRACCIÓN



CAPACIDAD



RAL 7035 + RAL 7016



RAL 5012



RAL 7035



Armario con 8 cajones 2x75 3x100 3x150



ART.	cajones		RAL
M53A100C010DDPD	100-75-50	92-96-100%	7035+7016
M53A100C010DD08	100-75-50	92-96-100%	7035
M53A100C010DD04	100-75-50	92-96-100%	5012
M53A100C010DEPD	200	100%	7035+7016
M53A100C010DE08	200	100%	7035
M53A100C010DE04	200	100%	5012

H=1000 mm

Armario con 10 cajones 1x50 2x75 7x100



ART.	cajones		RAL
M53A100C010DFPD	100-75-50	92-96-100%	7035+7016
M53A100C010DF08	100-75-50	92-96-100%	7035
M53A100C010DF04	100-75-50	92-96-100%	5012
M53A100C010DGPD	200	100%	7035+7016
M53A100C010DG08	200	100%	7035
M53A100C010DG04	200	100%	5012

H=1000 mm Los cajones H=50 mm siempre tienen extracción flexible

Armario con 9 cajones 2x75 2x100 1x150 3x200 1x300



ART.	cajones		RAL
M53A150C010LXPD	100-75-50	92-96-100%	7035+7016
M53A150C010LX08	100-75-50	92-96-100%	7035
M53A150C010LX04	100-75-50	92-96-100%	5012
M53A150C010LYPD	200	100%	7035+7016
M53A150C010LY08	200	100%	7035
M53A150C010LY04	200	100%	5012

H=1500 mm

Armario con 9 cajones 2x100 6x150 1x300



ART.	cajones		RAL
M53A150C010FJPD	100-75-50	92-96-100%	7035+7016
M53A150C010FJ08	100-75-50	92-96-100%	7035
M53A150C010FJ04	100-75-50	92-96-100%	5012
M53A150C010FKPD	200	100%	7035+7016
M53A150C010FK08	200	100%	7035
M53A150C010FK04	200	100%	5012

H=1500 mm



Armario con 10 cajones 1x50 4x100 1x150 4x200

ART.	cajones		RAL
M53A150C010LZPD	100-75-50	92-96-100%	7035+7016
M53A150C010LZ08	100-75-50	92-96-100%	7035
M53A150C010LZ04	100-75-50	92-96-100%	5012
M53A150C010MAPD	200	100%	7035+7016
M53A150C010MA08	200	100%	7035
M53A150C010MA04	200	100%	5012

H=1500 mm Los cajones H=50 mm siempre tienen extracción flexible



Armario 2xPF 2xPE

ART.	estantes extraíbles		RAL
M53A200C010SVPD	200	100%	7035+7016
M53A200C010SV08	200	100%	7035
M53A200C010SV04	200	100%	5012

H=2000 mm



Armario con 4 cajones 2xPF 1x150 1x200 1x250 1x300

ART.	cajones		RAL
M53A200C010SXPD	200	100%	7035+7016
M53A200C010SX08	200	100%	7035
M53A200C010SX04	200	100%	5012

H=2000 mm





Armario con 7 cajones 2xPF 1x50 1x75 1x100 1x125 1x150 2x200



ART.	cajones		RAL	
M53A200C010SWPD	200	100%	7035+7016	
M53A200C010SW08	200	100%	7035	
M53A200C010SW04	200	100%	5012	

H=2000 mm Los cajones H=50 mm siempre tienen extracción flexible



Armario con puertas 2xPF 2xPE

ART.	estantes extraíbles		RAL	
M53A200C010SUPD	100-75-50	92-96-100%	7035+7016	
M53A200C010SU08	100-75-50	92-96-100%	7035	
M53A200C010SU04	100-75-50	92-96-100%	5012	

H=2000 mm



Armario con puertas con 7 cajones 3xPR 2x75 1x100 3x150 1x200

ART.	cajones		RAL	
M53A200C010FYPD	100-75-50	92-96-100%	7035+7016	
M53A200C010FY08	100-75-50	92-96-100%	7035	
M53A200C010FY04	100-75-50	92-96-100%	5012	
M53A200C010FZPD	200	100%	7035+7016	
M53A200C010FZ08	200	100%	7035	
M53A200C010FZ04	200	100%	5012	

H=2000 mm



Armario con puertas con 3 cajones 2xPR 2x100 1x150 2xPE

ART.	cajones / estantes extraíbles		RAL	
	KG			
M53A200C010FWPD	100-75-50	92-96-100%	7035+7016	
M53A200C010FW08	100-75-50	92-96-100%	7035	
M53A200C010FW04	100-75-50	92-96-100%	5012	
M53A200C010FXPD	200	100%	7035+7016	
M53A200C010FX08	200	100%	7035	
M53A200C010FX04	200	100%	5012	

H=2000 mm



Armario con ruedas con 7 cajones 2x75 3x100 2x150

ART.	cajones		RAL	
	KG			
M53R085C01095PD	100-75-50	92-96-100%	7035+7016	
M53R085C0109508	100-75-50	92-96-100%	7035	
M53R085C0109504	100-75-50	92-96-100%	5012	

H=1072 mm

Ruedas: Goma elástica Ø 160 mm
Capacidad del armario: 900 kg



PE: ESTANTE EXTRAÍBLE
PR: ESTANTE REGULABLE
PF: ESTANTERANURADO



DIM. INTERNAS A x P



EXTRACCIÓN



CAPACIDAD



RAL 7035 + RAL 7016



RAL 5012



RAL 7035



Armario con 7 cajones 2x75 2x100 1x150 2x200



ART.	cajones		RAL
M63A100C010DYPD	100-75-50	92-96-100%	7035+7016
M63A100C010DY08	100-75-50	92-96-100%	7035
M63A100C010DY04	100-75-50	92-96-100%	5012
M63A100C010DZPD	200	100%	7035+7016
M63A100C010DZ08	200	100%	7035
M63A100C010DZ04	200	100%	5012

H=1000 mm

Armario con 8 cajones 2x75 4x100 1x150 1x200



ART.	cajones		RAL
M63A100C010CNP	100-75-50	92-96-100%	7035+7016
M63A100C010CN08	100-75-50	92-96-100%	7035
M63A100C010CN04	100-75-50	92-96-100%	5012
M63A100C010CPPD	200	100%	7035+7016
M63A100C010CP08	200	100%	7035
M63A100C010CP04	200	100%	5012

H=1000 mm

Armario con 8 cajones 2x75 3x100 3x150



ART.	cajones		RAL
M63A100C010DDPD	100-75-50	92-96-100%	7035+7016
M63A100C010DD08	100-75-50	92-96-100%	7035
M63A100C010DD04	100-75-50	92-96-100%	5012
M63A100C010DEPD	200	100%	7035+7016
M63A100C010DE08	200	100%	7035
M63A100C010DE04	200	100%	5012

H=1000 mm

Armario con 10 cajones 2x150 1x125 1x75 2x100 2x150 2x200



ART.	cajones		RAL
M63A150C010MCPD	200	100%	7035+7016
M63A150C010MC08	200	100%	7035
M63A150C010MC04	200	100%	5012

H=1500 mm



Armario con 11 cajones 1x150 1x125 1x75 4x100 3x150 1x200

ART.	cajones		RAL	
	KG			
M63A150C010MEPD	200	100%	7035+7016	
M63A150C010ME08	200	100%	7035	
M63A150C010ME04	200	100%	5012	

H=1500 mm



Armario con 7 cajones 2xPR 2x75 1x100 3x150 1x200

ART.	cajones		RAL	
	KG			
M63A200C010FTPD	200	100%	7035+7016	
M63A200C010FT08	200	100%	7035	
M63A200C010FT04	200	100%	5012	

H=2000 mm



Armario con puertas con 7 cajones 3xPR 2x75 1x100 3x150 1x200

ART.	cajones		RAL	
	KG			
M63A200C010FZPD	200	100%	7035+7016	
M63A200C010FZ08	200	100%	7035	
M63A200C010FZ04	200	100%	5012	

H=2000 mm



Armario con 5 cajones 2x100 2x200 1x300



ART.	cajones		RAL
M73A100C010EAPD	100-75-50	92-96-100%	7035+7016
M73A100C010EA08	100-75-50	92-96-100%	7035
M73A100C010EA04	100-75-50	92-96-100%	5012
M73A100C010EBPD	200	100%	7035+7016
M73A100C010EB08	200	100%	7035
M73A100C010EB04	200	100%	5012

H=1000 mm

Armario con 7 cajones 2x75 2x100 1x150 2x200



ART.	cajones		RAL
M73A100C010DYPD	100-75-50	92-96-100%	7035+7016
M73A100C010DY08	100-75-50	92-96-100%	7035
M73A100C010DY04	100-75-50	92-96-100%	5012
M73A100C010DZPD	200	100%	7035+7016
M73A100C010DZ08	200	100%	7035
M73A100C010DZ04	200	100%	5012

H=1000 mm

Armario con 8 cajones 2x75 4x100 1x150 1x200



ART.	cajones		RAL
M73A100C010CNP	100-75-50	92-96-100%	7035+7016
M73A100C010CN08	100-75-50	92-96-100%	7035
M73A100C010CN04	100-75-50	92-96-100%	5012
M73A100C010CPPD	200	100%	7035+7016
M73A100C010CP08	200	100%	7035
M73A100C010CP04	200	100%	5012

H=1000 mm



Armario con 10 cajones 2x150 1x125 1x75 2x100 2x150 2x200

ART.	cajones		RAL
M73A150C010MCPD	200	100%	7035+7016
M73A150C010MC08	200	100%	7035
M73A150C010MC04	200	100%	5012

H=1500 mm



Armario con 11 cajones 1x150 1x125 1x75 4x100 3x150 1x200

ART.	cajones		RAL	
	KG			
M73A150C010MEPD	200	100%	7035+7016	
M73A150C010ME08	200	100%	7035	
M73A150C010ME04	200	100%	5012	

H=1500 mm



Armario con 7 cajones 2xPR 2x75 1x100 3x150 1x200

ART.	cajones		RAL	
	KG			
M73A200C010FTPD	200	100%	7035+7016	
M73A200C010FT08	200	100%	7035	
M73A200C010FT04	200	100%	5012	

H=2000 mm



Armario con puertas con 7 cajones 3xPR 2x75 1x100 3x150 1x200

ART.	cajones		RAL	
	KG			
M73A200C010FZPD	200	100%	7035+7016	
M73A200C010FZ08	200	100%	7035	
M73A200C010FZ04	200	100%	5012	

H=2000 mm



Accesorios



Top de acero inoxidable

ART.	adaptado para el armario EH	A mm	P mm	H mm	
M12T030MDNX710A	18x27	408	573	31	
M22T030MDNX710A	27x27	561	573	31	
M32T030MDNX710A	36x27	714	573	31	
M52T030MDNX710A	54x27	1020	573	31	
M23T030MDNX710A	27x36	561	726	31	
M33T030MDNX710A	36x36	714	726	31	
M43T030MDNX710A	45x36	867	726	31	
M53T030MDNX710A	54x36	1020	726	31	
M63T030MDNX710A	64x36	1190	726	31	
M73T030MDNX710A	78x36	1428	726	31	



Top de acero de goma

ART.	adaptado para el armario EH	A mm	P mm	H mm	color	
M12T030MDGM7107	18x27	408	573	32	Negro	
M22T030MDGM7107	27x27	561	573	32	Negro	
M32T030MDGM7107	36x27	714	573	32	Negro	
M52T030MDGM7107	54x27	1020	573	32	Negro	
M23T030MDGM7107	27x36	561	726	32	Negro	
M33T030MDGM7107	36x36	714	726	32	Negro	
M43T030MDGM7107	45x36	867	726	32	Negro	
M53T030MDGM7107	54x36	1020	726	32	Negro	
M63T030MDGM7107	64x36	1190	726	32	Negro	
M73T030MDGM7107	78x36	1428	726	32	Negro	



Top de multiplex

ART.	adaptado para el armario EH	A mm	P mm	H mm	
M12T030MU000100	18x27	408	573	30	
M22T030MU000100	27x27	561	573	30	
M32T030MU000100	36x27	714	573	30	
M52T030MU000100	54x27	1020	573	30	
M23T030MU000100	27x36	561	726	30	
M33T030MU000100	36x36	714	726	30	
M43T030MU000100	45x36	867	726	30	
M53T030MU000100	54x36	1020	726	30	
M63T030MU000100	64x36	1190	726	30	
M73T030MU000100	78x36	1428	726	30	



Accesorios



Encimera de 3 bordes revestida de PVC

ART.	adaptado para el armario EH	A mm	P mm	H mm	color	
M12T023AG003107	18x27	409	576	23	Negro	
M22T023AG003107	27x27	562	576	23	Negro	
M32T023AG003107	36x27	715	576	23	Negro	
M52T023AG003107	54x27	1021	576	23	Negro	
M23T023AG003107	27x36	562	729	23	Negro	
M33T023AG003107	36x36	715	729	23	Negro	
M43T023AG003107	45x36	868	729	23	Negro	
M53T023AG003107	54x36	1021	729	23	Negro	
M63T023AG003107	64x36	1191	729	23	Negro	
M73T023AG003107	78x36	1429	729	23	Negro	

Zócalo de elevación H=50 mm



ART.	adaptado para el armario EH	A mm	P mm	H mm	RAL	
M12Z05000000008	18x27	406	572	50	7035	
M12Z05000000004	18x27	406	572	50	5012	
M22Z05000000008	27x27	559	572	50	7035	
M22Z05000000004	27x27	559	572	50	5012	
M32Z05000000008	36x27	712	572	50	7035	
M32Z05000000004	36x27	712	572	50	5012	
M52Z05000000008	54x27	1018	572	50	7035	
M52Z05000000004	54x27	1018	572	50	5012	
M23Z05000000008	27x36	559	725	50	7035	
M23Z05000000004	27x36	559	725	50	5012	
M33Z05000000008	36x36	712	725	50	7035	
M33Z05000000004	36x36	712	725	50	5012	
M43Z05000000008	45x36	865	725	50	7035	
M43Z05000000004	45x36	865	725	50	5012	
M53Z05000000008	54x36	1018	725	50	7035	
M53Z05000000004	54x36	1018	725	50	5012	
M63Z05000000008	64x36	1188	725	50	7035	
M63Z05000000004	64x36	1188	725	50	5012	
M73Z05000000008	78x36	1426	725	50	7035	
M73Z05000000004	78x36	1426	725	50	5012	



Accesorios



Zócalo de elevación H=100 mm

ART.	adaptado para el armario EH	A mm	P mm	H mm	RAL	
M12Z10000000008	18x27	406	572	100	7035	
M12Z10000000004	18x27	406	572	100	5012	
M22Z10000000008	27x27	559	572	100	7035	
M22Z10000000004	27x27	559	572	100	5012	
M32Z10000000008	36x27	712	572	100	7035	
M32Z10000000004	36x27	712	572	100	5012	
M52Z10000000008	54x27	1018	572	100	7035	
M52Z10000000004	54x27	1018	572	100	5012	
M23Z10000000008	27x36	559	725	100	7035	
M23Z10000000004	27x36	559	725	100	5012	
M33Z10000000008	36x36	712	725	100	7035	
M33Z10000000004	36x36	712	725	100	5012	
M43Z10000000008	45x36	865	725	100	7035	
M43Z10000000004	45x36	865	725	100	5012	
M53Z10000000008	54x36	1018	725	100	7035	
M53Z10000000004	54x36	1018	725	100	5012	
M63Z10000000008	64x36	1188	725	100	7035	
M63Z10000000004	64x36	1188	725	100	5012	
M73Z10000000008	78x36	1426	725	100	7035	
M73Z10000000004	78x36	1426	725	100	5012	





Accesorios



Zócalo para carro elevador y transpallet

ART.	adaptado para el armario EH	A mm	P mm	H mm	RAL
M32Z10010000007	36x27	712	569	100	9005
M23Z10010000007	27x36	559	722	100	9005
M33Z10010000007	36x36	712	722	100	9005
M43Z10010000007	45x36	865	722	100	9005



Cierre para zócalo

ART.	adaptado para el armario A EH	A mm	P mm	H mm	RAL
M20Z10011000007	27	555	46	95	9005
M30Z10011000007	36	708	46	95	9005
M40Z10011000007	45	861	46	95	9005



Par de zócalos para carro elevador y transpallet

ART.	adaptado para el armario EH	A mm	P mm	H mm	RAL
M02Z10020000007	54x27	200	569	100	9005
M03Z10020000007	54x36 64x36 78x36	200	722	100	9005



Cierre para zócalo

ART.	adaptado para el armario A EH	A mm	P mm	H mm	RAL
M50Z10021000007	54	1014	46	95	9005
M60Z10021000007	64	1184	46	95	9005
M70Z10021000007	78	1422	46	95	9005





Material de separación

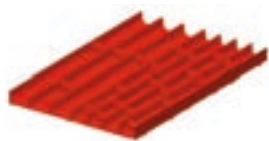

ART.	apto para cajón H mm	componentes	
FFH82050200	50/300	16 x Divisor transversal A=36 mm 7 x Divisor transversal A=47 mm 3 x Divisor de 3 canales 3 x Divisor de 4 canales	

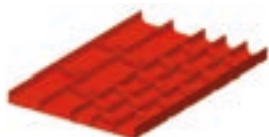

ART.	apto para cajón H mm	componentes	
FFH82050300	50/300	15 x Divisor transversal A=47 mm 8 x Divisor transversal A=73 mm 3 x Divisor de 2 canales 3 x Divisor de 3 canales	

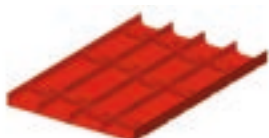

ART.	apto para cajón H mm	componentes	
FFH82050400	50/300	18 x Divisor transversal A=73 mm 6 x Divisor de 2 canales	



ART.	apto para cajón H mm	componentes	
FFH80050800	50	2 x Divisor transversal A=151 mm 1 x Separador longitudinal ranurado A=457 mm	
FFH80070800	75		
FFH80100800	100/125		
FFH80150800	150/175		
FFH80200800	200/250		
FFH80300800	300		



ART.	apto para cajón H mm	componentes	
FFH80050900	50	2 x Separador longitudinal ranurado A=457 mm 6 x Divisor transversal A=100 mm	
FFH80070900	75		
FFH80100900	100/125		
FFH80150900	150/175		

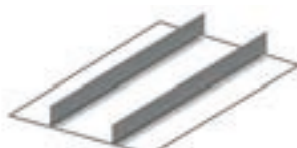

ART.	apto para cajón H mm	componentes	
FFH84051300	50	2 x Separador longitudinal no ranurado A=457 mm	
FFH84071300	75		
FFH84101300	100/125		
FFH84151300	150/175		
FFH84201300	200/250		



Material de separación

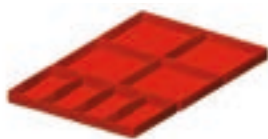

ART.	apto para cajón H mm	componentes	
FFH82051800	50		
FFH82071800	75	4 x Caja divisor 150x75 mm 4 x Caja divisor 150x150 mm	
FFH82101800	100/125		

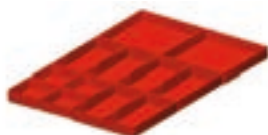

ART.	apto para cajón H mm	componentes	
FFH82051700	50	4 x Caja divisor 75x75 mm 6 x Caja divisor 150x75 mm	
FFH82071700	75	2 x Caja divisor 150x150 mm	

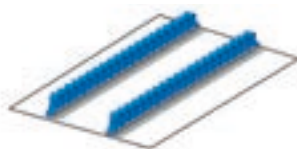

ART.	apto para cajón H mm	componentes	
FFH86051900	50/300	2 x Portaherramientas multiuso	





Material de separación

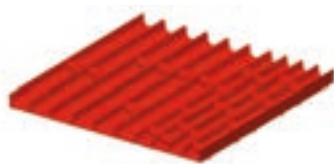

ART.	apto para cajón H mm	componentes	
FFH84050200	50/300	16 x Divisor transversal A=36 mm 7 x Divisor transversal A=47 mm 6 x Divisor de 3 canales 3 x Divisor de 4 canales	

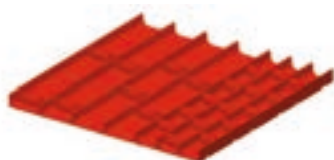

ART.	apto para cajón H mm	componentes	
FFH84050300	50/300	15 x Divisor transversal A=47 mm 8 x Divisor transversal A=73 mm 6 x Divisor de 2 canales 3 x Divisor de 3 canales	

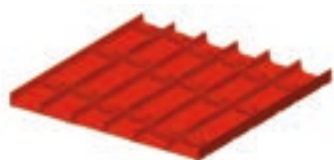

ART.	apto para cajón H mm	componentes	
FFH84050400	50/300	18 x Divisor transversal A=73 mm 9 x Divisor de 2 canales	



ART.	apto para cajón H mm	componentes	
FFH84050800	50	2 x Divisor longitudinal ranurado A=457 mm 3 x Divisor transversal A=151 mm	
FFH84070800	75		
FFH84100800	100/125		
FFH84150800	150/175		
FFH84200800	200/250		
FFH84300800	300		



ART.	apto para cajón H mm	componentes	
FFH84050900	50	2 x Separador longitudinal ranurado A=457 mm 7 x Divisor transversal A=151 mm	
FFH84070900	75		
FFH84100900	100/125		
FFH84150900	150/175		
FFH84200900	200/250		

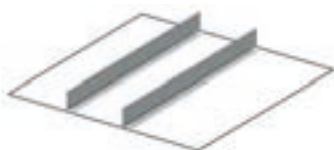

ART.	apto para cajón H mm	componentes	
FFH84051300	50	2 x Separador longitudinal no ranurado A=457 mm	
FFH84071300	75		
FFH84101300	100/125		
FFH84151300	150/175		
FFH84201300	200/250		



Material de separación

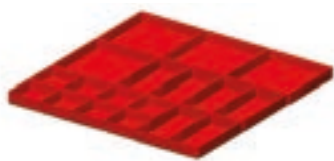

ART.	apto para cajón H mm	componentes	
FFH84051700	50	8 x Caja divisor 75x75 mm 6 x Caja divisor 150x75 mm 4 x Caja divisor 150x150 mm	
FFH84071700	75		

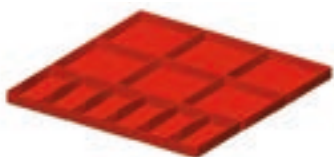

ART.	apto para cajón H mm	componentes	
FFH84051800	50	6 x Caja divisor 150x75 mm 6 x Caja divisor 150x150 mm	
FFH84071800	75		
FFH84101800	100/125		

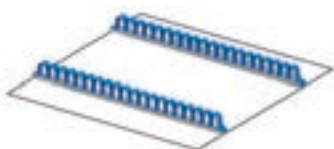

ART.	apto para cajón H mm	componentes	
FFH86051900	50/300	2 x Portaherramientas multiuso	





Material de separación

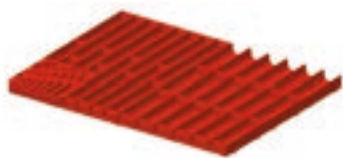

ART.	apto para cajón H mm	componentes	
FFH10051500	50/300	20 x Divisor transversal A=36 mm 20 x Divisor transversal A=47 mm 6 x Divisor de 3 canales 5 x Divisor de 4 canales 1 x Porta llaves Allen	

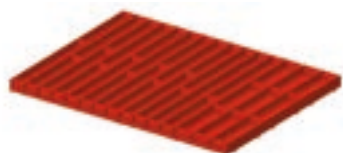

ART.	apto para cajón H mm	componentes	
FFH10051000	50/300	3 x Divisor de 3 canales 9 x Divisor de 4 canales 12 x Divisor transversal A=47 mm 36 x Divisor transversal A=36 mm	

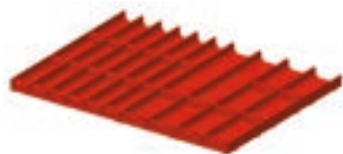

ART.	apto para cajón H mm	componentes	
FFH10051300	50/300	18 x Divisor transversal A=47 mm 12 x Divisor transversal A=73 mm 6 x Divisor de 2 canales 6 x Divisor de 3 canales	

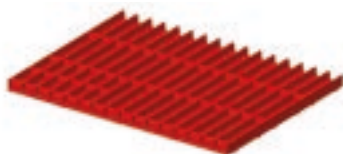

ART.	apto para cajón H mm	componentes	
FFH10052100	50/300	12 x Divisor de 4 canales 65 x Divisor transversal A=36 mm	

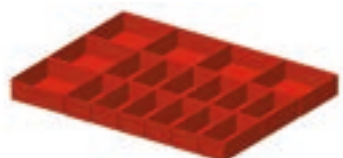

ART.	apto para cajón H mm	componentes	
FFH10051600	50	12 x Caja divisor 150x75 mm 6 x Caja divisor 150x150 mm	
FFH10071600	75		
FFH10101600	100/125		

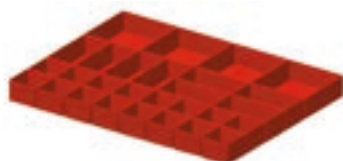

ART.	apto para cajón H mm	componentes	
FFH10051800	50	16 x Caja divisor 75x75 mm 8 x Caja divisor 150x75 mm 4 x Caja divisor 150x150 mm	
FFH10071800	75		



Material de separación



ART.	apto para cajón H mm	componentes	
FFH10050500	50	2 x Separador longitudinal ranurado A=457 mm 3 x Divisor transversal A=202 mm	
FFH10070500	75		
FFH10100500	100/125		
FFH10150500	150/175		
FFH10200500	200/250		
FFH10300500	300		



ART.	apto para cajón H mm	componentes	
FFH10050300	50	3 x Separador longitudinal ranurado A=457 mm 8 x Divisor transversal A=151 mm	
FFH10070300	75		
FFH10100300	100/125		
FFH10150300	150/175		
FFH10200300	200/250		

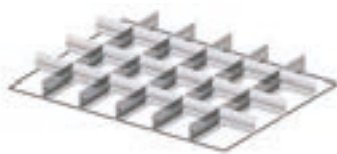

ART.	apto para cajón H mm	componentes	
FFH10052200	50	5 x Separador longitudinal ranurado A=457 mm 18 x Divisor transversal A=100 mm	
FFH10072200	75		
FFH10102200	100/125		
FFH10152200	150/175		



ART.	apto para cajón H mm	componentes	
FFH84051300	50	2 x Separador longitudinal no ranurado A=457 mm	
FFH84071300	75		
FFH84101300	100/125		
FFH84151300	150/175		
FFH84201300	200/250		





Material de separación

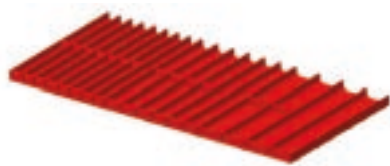

ART.	apto para cajón H mm	componentes	
FFH40051200	50/300	15 x Divisor transversal A=36 mm 10 x Divisor transversal A=47 mm 6 x Divisor transversal A=73 mm 6 x Divisor de 2 canales 6 x Divisor de 3 canales 6 x Divisor de 4 canales	

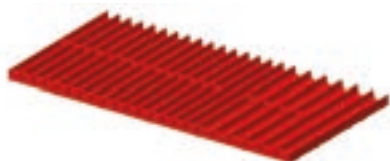

ART.	apto para cajón H mm	componentes	
FFH40051500	50/300	30 x Divisor transversal A=36 mm 10 x Divisor transversal A=47 mm 6 x Divisor de 3 canales 12 x Divisor de 4 canales	

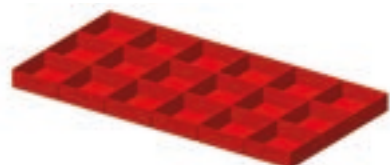

ART.	apto para cajón H mm	componentes	
FFH40051100	50	18 x Caja divisor 150x150 mm	
FFH40071100	75		
FFH40101100	100/125		



ART.	apto para cajón H mm	componentes	
FFH40051300	50	12 x Caja divisor 150x75 mm 12 x Caja divisor 150x150 mm	
FFH40071300	75		
FFH40101300	100/125		

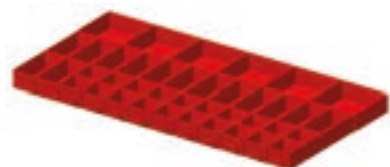

ART.	apto para cajón H mm	componentes	
FFH40051600	50	20 x Caja divisor 75x75 mm 14 x Caja divisor 150x75 mm 6 x Caja divisor 150x150 mm	
FFH40071600	75		



ART.	apto para cajón H mm	componentes	
FFH40050300	50	5 x Separador longitudinal ranurado A=457 mm 12 x Divisor transversal A=151 mm	
FFH40070300	75		
FFH40100300	100/125		
FFH40150300	150/175		
FFH40200300	200/250		



Material de separación

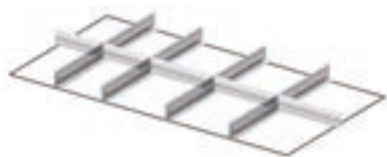

ART.	apto para cajón H mm	componentes	
FFH40050500	50	4 x Separador longitudinal ranurado A=457 mm 2 x Divisor transversal A=151 mm 3 x Divisor transversal A=202 mm	
FFH40070500	75		
FFH40100500	100/125		
FFH40150500	150/175		
FFH40200500	200/250		



ART.	apto para cajón H mm	componentes	
FFH40052000	50	2 x Separador longitudinal ranurado A=457 mm 2 x Divisor transversal A=304 mm	
FFH40072000	75		
FFH40102000	100/125		
FFH40152000	150/175		
FFH40202000	200/250		
FFH40302000	300		



ART.	apto para cajón H mm	componentes	
FFH40050600	50	7 x Separador longitudinal ranurado A=457 mm 12 x Divisor transversal A=100 mm 2 x Divisor transversal A=151 mm	
FFH40070600	75		
FFH40100600	100/125		





Material de separación



ART.	apto para cajón H mm	componentes	
FFH86050100	50/300	50 x Divisor transversal A=36 mm 12 x Divisor de 4 canales	



ART.	apto para cajón H mm	componentes	
FFH86050200	50/300	4 x Divisor de 4 canales 8 x Divisor de 3 canales 20 x Divisor transversal A=36 mm 10 x Divisor transversal A=47 mm	



ART.	apto para cajón H mm	componentes	
FFH86050300	50/300	4 x Divisor de 3 canales 8 x Divisor de 2 canales 20 x Divisor transversal A=47 mm 10 x Divisor transversal A=73 mm	



ART.	apto para cajón H mm	componentes	
FFH86051600	50	16 x Caja divisor con divisor fijo 75x75 mm 16 x Caja divisor 75x75 mm 4 x Caja divisor 150x75 mm 2 x Caja divisor 150x150 mm	
FFH86071600	75		



ART.	apto para cajón H mm	componentes	
FFH86051700	50	16 x Caja divisor 75x75 mm 8 x Caja divisor 150x75 mm 4 x Caja divisor 150x150 mm	
FFH86071700	75		



ART.	apto para cajón H mm	componentes	
FFH86051800	50	12 x Caja divisor 150x75 mm 6 x Caja divisor 150x150 mm	
FFH86071800	75		
FFH86101800	100/125		



Material de separación



ART.	apto para cajón H mm	componentes	
FFH86050700	50	1 x Separador longitudinal ranurado A=610 mm 1 x Divisor transversal A=202 mm 1 x Divisor transversal A=253 mm	
FFH86070700	75		
FFH86100700	100/125		
FFH86150700	150/175		
FFH86200700	200/250		
FFH86300700	300		

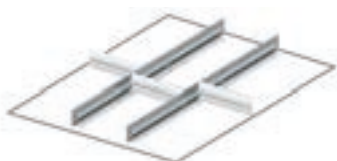

ART.	apto para cajón H mm	componentes	
FFH86050800	50	2 x Separador longitudinal ranurado A=610 mm 3 x Divisor transversal A=151 mm	
FFH86070800	75		
FFH86100800	100/125		
FFH86150800	150/175		
FFH86200800	200/250		
FFH86300800	300		

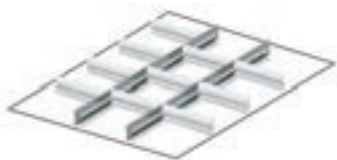

ART.	apto para cajón H mm	componentes	
FFH86050900	50	2 x Separador longitudinal ranurado A=610 mm 10 x Divisor transversal A=151 mm	
FFH86070900	75		
FFH86100900	100/125		
FFH86150900	150/175		
FFH86200900	200/250		



ART.	apto para cajón H mm	componentes	
FFH86051000	50	3 x Separador longitudinal ranurado A=610 mm 6 x Divisor transversal A=100 mm 2 x Divisor transversal A=151 mm	
FFH86071000	75		
FFH86101000	100/125		
FFH86151000	150/175		

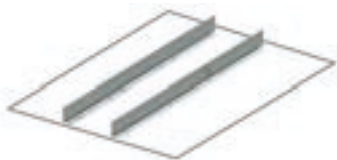

ART.	apto para cajón H mm	componentes	
FFH86051300	50	2 x Separador longitudinal no ranurado A=610 mm	
FFH86071300	75		
FFH86101300	100/125		
FFH86151300	150/175		
FFH86201300	200/250		
FFH86301300	300		

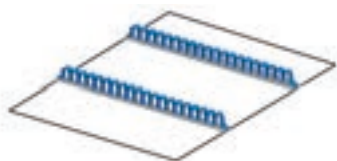

ART.	apto para cajón H mm	componentes	
FFH86051900	50/300	2 x Portaherramientas multiuso	



Material de separación

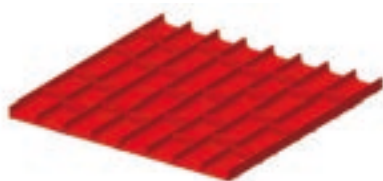

ART.	apto para cajón H mm	componentes	
FFH20051500	50/300	35 x Divisor transversal A=73 mm 16 x Divisor de 2 canales	

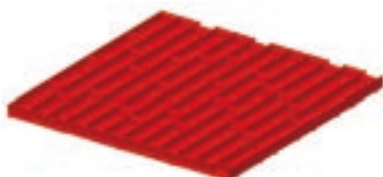

ART.	apto para cajón H mm	componentes	
FFH20051600	50/300	50 x Divisor transversal A=47 mm 16 x Divisor de 3 canales	

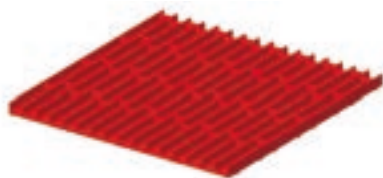

ART.	apto para cajón H mm	componentes	
FFH20051700	50/300	65 x Divisor transversal A=36 mm 16 x Divisor de 4 canales	

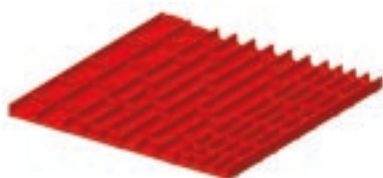

ART.	apto para cajón H mm	componentes	
FFH20052000	50/300	30 x Divisor transversal A=36 mm 20 x Divisor transversal A=47 mm 10 x Divisor transversal A=73 mm 4 x Divisor de 2 canales 8 x Divisor de 3 canales 4 x Divisor de 4 canales	

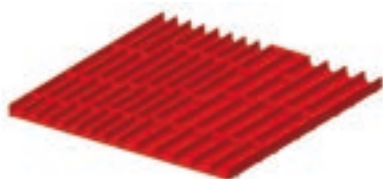

ART.	apto para cajón H mm	componentes	
FFH20052100	50/300	8 x Divisor de 3 canales 8 x Divisor de 4 canales 16 x Divisor transversal A=47 mm 24 x Divisor transversal A=36 mm	

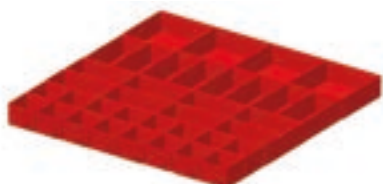

ART.	apto para cajón H mm	componentes	
FFH20051200	50	16 x Caja divisor 75x75 mm 16 x Caja divisor 150x75 mm	
FFH20071200	75	4 x Caja divisor 150x150 mm	



Material de separación

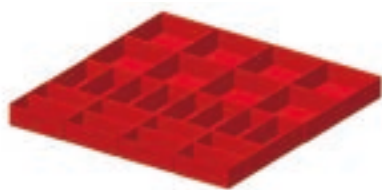

ART.	apto para cajón H mm	componentes	
FFH20051300	50	16 x Caja divisor 150x75 mm 8 x Caja divisor 150x150 mm	
FFH20071300	75		
FFH20101300	100/125		



ART.	apto para cajón H mm	componentes	
FFH20050500	50	1 x Separador longitudinal ranurado A=610 mm 2 x Divisor transversal A=304 mm	
FFH20070500	75		
FFH20100500	100/125		
FFH20150500	150/175		
FFH20200500	200/250		
FFH20300500	300		



ART.	apto para cajón H mm	componentes	
FFH20050600	50	2 x Separador longitudinal ranurado A=610 mm 3 x Divisor transversal A=202 mm	
FFH20070600	75		
FFH20100600	100/125		
FFH20150600	150/175		
FFH20200600	200/250		
FFH20300600	300		



ART.	apto para cajón H mm	componentes	
FFH20050700	50	3 x Separador longitudinal ranurado A=610 mm 15 x Divisor transversal A=151 mm	
FFH20070700	75		
FFH20100700	100/125		
FFH20150700	150/175		
FFH20200700	200/250		



ART.	apto para cajón H mm	componentes	
FFH20050800	50	4 x Separador longitudinal ranurado A=610 mm 9 x Divisor transversal A=151 mm 12 x Divisor transversal A=100 mm	
FFH20070800	75		
FFH20100800	100/125		



ART.	apto para cajón H mm	componentes	
FFH20050900	50	5 x Separador longitudinal ranurado A=610 mm 20 x Divisor transversal A=100 mm	
FFH20070900	75		
FFH20100900	100/125		
FFH20150900	150/175		



Material de separación

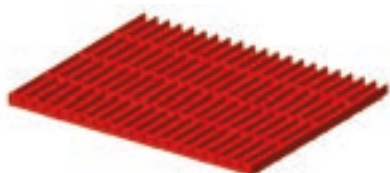

ART.	apto para cajón H mm	componentes	
FFH30051000	50/300	130 x Divisor transversal A=36 mm 20 x Divisor de 4 canales	

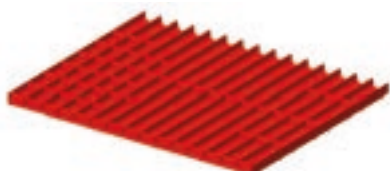

ART.	apto para cajón H mm	componentes	
FFH30051200	50/300	100 x Divisor transversal A=47 mm 20 x Divisor de 3 canales	

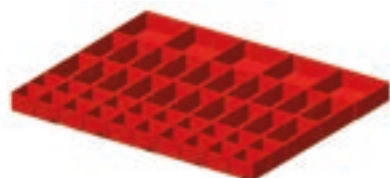

ART.	apto para cajón H mm	componentes	
FFH30050700	50	20 x Caja divisor 75x75 mm	
FFH30070700	75	20 x Caja divisor 150x75 mm 5 x Caja divisor 150x150 mm	

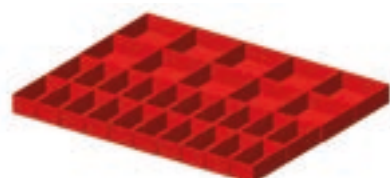

ART.	apto para cajón H mm	componentes	
FFH30050800	50	20 x Caja divisor 150x75 mm 10 x Caja divisor 150x150 mm	
FFH30070800	75		
FFH30100800	100/125		

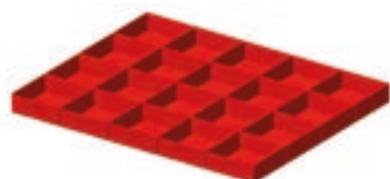

ART.	apto para cajón H mm	componentes	
FFH30050900	50	20 x Caja divisor 150x150 mm	
FFH30070900	75		
FFH30100900	100/125		

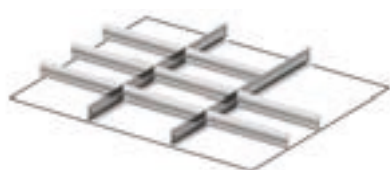

ART.	apto para cajón H mm	componentes	
FFH30100200	100/125	2 x Separador longitudinal ranurado A=610 mm 8 x Divisor transversal A=253 mm	
FFH30150200	150/175		
FFH30200200	200/250		
FFH30300200	300		



Material de separación

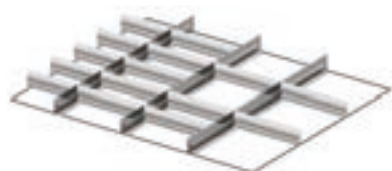
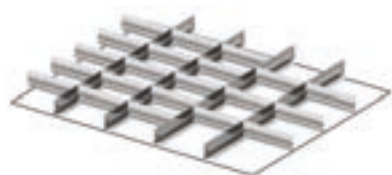

ART.	apto para cajón H mm	componentes	
FFH30070300	75	4 x Separador longitudinal ranurado A=610 mm 21 x Divisor transversal A=151 mm	
FFH30100300	100/125		
FFH30150300	150/175		
FFH30200300	200/250		
FFH30300300	300		

ART.	apto para cajón H mm	componentes	
FFH30070400	75	3 x Separador longitudinal ranurado A=610 mm 5 x Divisor transversal A=151 mm 10 x Divisor transversal A=202 mm	
FFH30100400	100/125		
FFH30150400	150/175		
FFH30200400	200/250		
FFH30300400	300		





Material de separación

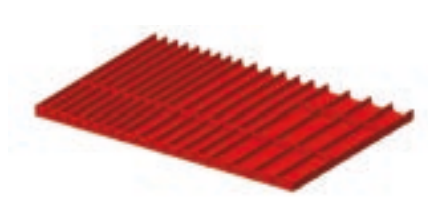

ART.	apto para cajón H mm	componentes	
FFH50050900	50/300	15 x Divisor transversal A=36 mm 10 x Divisor transversal A=47 mm 6 x Divisor transversal A=73 mm 8 x Divisor de 2 canales 8 x Divisor de 3 canales 8 x Divisor de 4 canales	

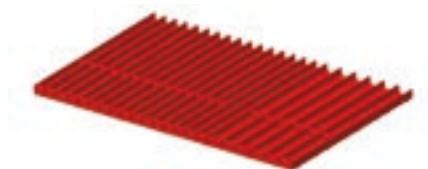

ART.	apto para cajón H mm	componentes	
FFH50051900	50/300	30 x Divisor transversal A=36 mm 10 x Divisor transversal A=47 mm 8 x Divisor de 3 canales 16 x Divisor de 4 canales	

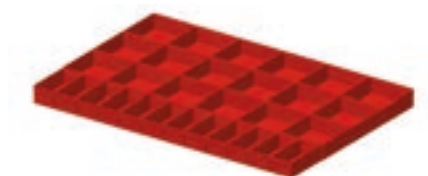

ART.	apto para cajón H mm	componentes	
FFH50050800	50	12 x Caja divisor 150x75 mm 18 x Caja divisor 150x150 mm	
FFH50070800	75		
FFH50100800	100/125		

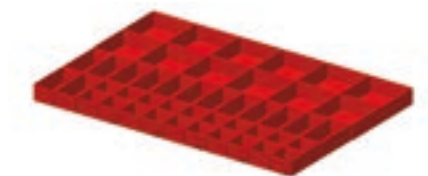

ART.	apto para cajón H mm	componentes	
FFH50051700	50	20 x Caja divisor 75x75 mm 14 x Caja divisor 150x75 mm 12 x Caja divisor 150x150 mm	
FFH50071700	75		

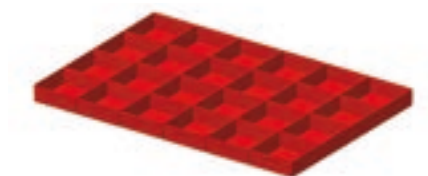

ART.	apto para cajón H mm	componentes	
FFH50051800	50	24 x Caja divisor 150x150 mm	
FFH50071800	75		
FFH50101800	100/125		

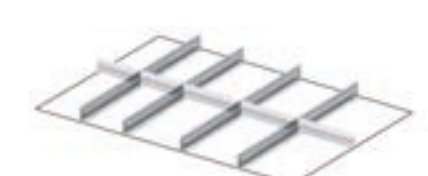

ART.	apto para cajón H mm	componentes	
FFH50050700	50	4 x Separador longitudinal ranurado A=610 mm 2 x Divisor transversal A=151 mm 3 x Divisor transversal A=202 mm	
FFH50070700	75		
FFH50100700	100/125		
FFH50150700	150/175		
FFH50200700	200/250		
FFH50300700	300		



Material de separación

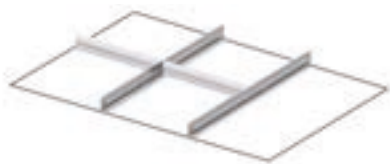

ART.	apto para cajón H mm	componentes	
FFH50051000	50	2 x Separador longitudinal ranurado A=610 mm 2 x Divisor transversal A=304 mm	
FFH50071000	75		
FFH50101000	100/125		
FFH50151000	150/175		
FFH50201000	200/250		
FFH50301000	300		

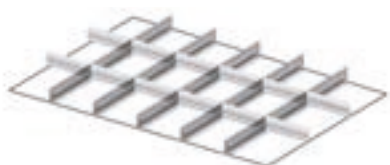

ART.	apto para cajón H mm	componentes	
FFH50051300	50	5 x Separador longitudinal ranurado A=610 mm 12 x Divisor transversal A=151 mm	
FFH50071300	75		
FFH50101300	100/125		
FFH50151300	150/175		
FFH50201300	200/250		
FFH50301300	300		

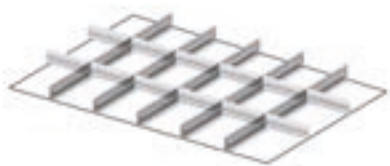

ART.	apto para cajón H mm	componentes	
FFH50051500	50	7 x Separador longitudinal ranurado A=610 mm 12 x Divisor transversal A=100 mm 2 x Divisor transversal A=151 mm	
FFH50071500	75		
FFH50101500	100/125		





Material de separación

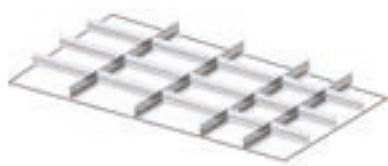

ART.	apto para cajón H mm	componentes	
FFH60070200	75	4 x Separador longitudinal ranurado A=610 mm 3 x Divisor transversal A=151 mm 3 x Divisor transversal A=168 mm 9 x Divisor transversal A=253 mm	
FFH60100200	100/125		
FFH60150200	150/175		
FFH60200200	200/250		

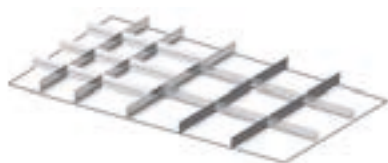

ART.	apto para cajón H mm	componentes	
FFH60070500	75	5 x Separador longitudinal ranurado A=610 mm 6 x Divisor transversal A=134 mm 9 x Divisor transversal A=202 mm	
FFH60100500	100/125		
FFH60150500	150/175		

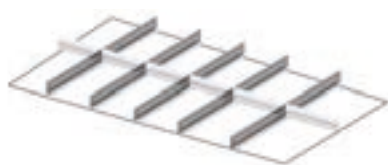

ART.	apto para cajón H mm	componentes	
FFH60070800	75	5 x Separador longitudinal ranurado A=610 mm 2 x Divisor transversal A=151 mm 1 x Divisor transversal A=168 mm 3 x Divisor transversal A=202 mm	
FFH60100800	100/125		
FFH60150800	150/175		
FFH60200800	200/250		
FFH60300800	300		



ART.	apto para cajón H mm	componentes	
FFH60071100	75	6 x Separador longitudinal ranurado A=610 mm 6 x Divisor transversal A=151 mm 1 x Divisor transversal A=168 mm	
FFH60101100	100/125		
FFH60151100	150/175		
FFH60201100	200/250		
FFH60301100	300		





Material de separación

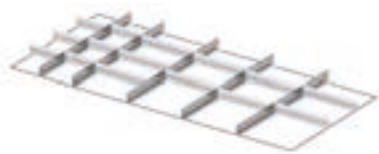

ART.	apto para cajón H mm	componentes	
FFH70070200	75	5 x Separador longitudinal ranurado A=610 mm 6 x Divisor transversal A=151 mm 9 x Divisor transversal A=253 mm	
FFH70100200	100/125		
FFH70150200	150/175		
FFH70200200	200/250		



ART.	apto para cajón H mm	componentes	
FFH70070300	75	6 x Separador longitudinal ranurado A=610 mm 3 x Divisor transversal A=134 mm 3 x Divisor transversal A=168 mm 14 x Divisor transversal A=202 mm	
FFH70100300	100/125		
FFH70150300	150/175		



ART.	apto para cajón H mm	componentes	
FFH70070700	75	6 x Separador longitudinal ranurado A=610 mm 4 x Divisor transversal A=151 mm 2 x Divisor transversal A=202 mm 1 x Divisor transversal A=304 mm	
FFH70100700	100/125		
FFH70150700	150/175		
FFH70200700	200/250		
FFH70300700	300		

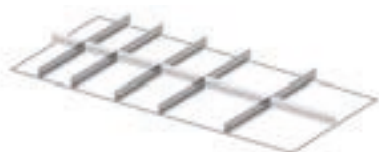

ART.	apto para cajón H mm	componentes	
FFH70070800	75	5 x Separador longitudinal ranurado A=610 mm 2 x Divisor transversal A=151 mm 2 x Divisor transversal A=202 mm 2 x Divisor transversal A=304 mm	
FFH70100800	100/125		
FFH70150800	150/175		
FFH70200800	200/250		
FFH70300800	300		



MASTER CS

ESTACIÓN PC

STANDARD CS

ESTACIÓN PC

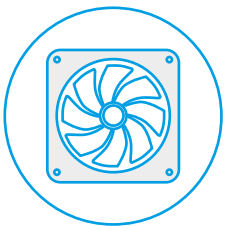

Ventilación forzada

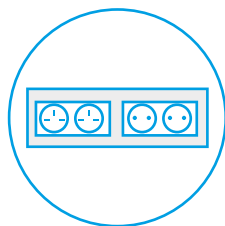

**Sistema eléctrico con
enchufes DE CH GB
FR**

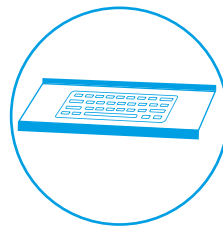

**Superficie para
teclado extraíble**

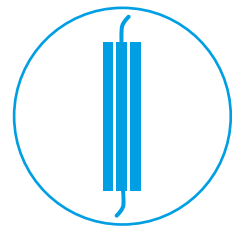

**Conducto para
gestión paso de cables**

ARMARIOS PORTAORDENADOR

MASTER CS

1. Puerta con cerradura de seguridad y cristal de policarbonato. Dimensiones útiles: 655x215x465 mm H.
2. Posibilidad de entrada de vídeo de hasta 21". Dimensiones internas del compartimento superior: 710x215x530 mm H.
3. Cajón extraíble con superficie portateclado y 2 posiciones de bloqueo, en apertura de espacio posterior para contención de objetos. Dimensiones útiles: 655x465 mm H.
4. Compartimento con posibilidad de inserción de estantes extraíbles y superficies regulables en altura para alojar sistemas de hardware e impresoras. Anchura de inserción útil: 663 mm. Altura útil: 754 mm.
5. Orificio para cables de red y orificio de salida del cable para el sistema eléctrico.
6. Orificio de entrada de aire con filtro antipolvo.
7. Sistema eléctrico con 4 tomas Schuko.
8. Conductos portacables de 4 carriles.
9. Ventilación de refrigeración con filtro antipolvo.
10. Estante flexible. Dimensiones: 602x449 mm.
11. Estante regulable. Dimensiones 663x560x52 mm H.



El armario puede adquirirse sin el módulo superior. Ideal para soluciones con ordenadores portátiles y pantallas táctiles.



STANDARD CS

12. Puerta con cerradura de seguridad y cristal de policarbonato. Dimensiones útiles: 661x525 mm H.
13. Posibilidad de entrada de vídeo de hasta 21". Dimensiones internas del compartimento superior: 690x600x580 mm H.
14. Superficie portateclado. Dimensiones útiles: 620x510 mm H.
15. Compartimento inferior con posibilidad de inserción de estantes extraíbles y superficies regulables en altura para alojar sistemas de hardware e impresoras. Dimensiones internas: 690x600x720 mm H.
16. Orificio para cables de red y orificio de salida del cable para el sistema eléctrico.
17. Orificio de entrada de aire con filtro antipolvo.
18. Sistema eléctrico con 4 tomas Schuko.
19. Conductos portacables de 4 carriles.
20. Ventilación de refrigeración con filtro antipolvo.
21. Estante flexible. Dimensiones: 650x582x36 mm H.
22. Estante regulable. Dimensiones 688x591x38 mm H.





Armario para ordenador con ruedas

ART.	A mm	P mm	H mm	set de ruedas	RAL	
MASTERCS01	792	617	1731	450	7035	

Compuesto por:

cant.	descripción
1	Armario inferior con 1 cajón
1	Armario superior con puerta de policarbonato
1	Asa de tubo
1	Estante extraíble de extracción flexible con asa Dark Grey
1	Soporte de toma
1	Toma múltiple Schuko de 4 compartimentos
1	Cable de conexión Wieland Schuko/FR
1	Ventilador 230V sin rejilla con clavija Schuko
1	Kit de ruedas de nailon Ø 100 mm



Armario superior con puerta de policarbonato

ART.	A mm	P mm	H mm	RAL	
FAS1450C01008	714	247	650	7035	



Armario superior con persiana

ART.	A mm	P mm	H mm	RAL	
FAS1450C02008	714	247	650	7035	

Posibilidad de incluir vídeo de hasta 24"

Posibilidad de incluir vídeo de hasta 24"

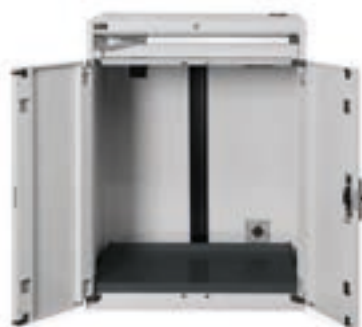

Armario inferior con 1 cajón

ART.	A mm	P mm	H mm		N. cajones	N. estantes porta teclado	N. estantes regulables	RAL	
FAS1400C00508	714	598	950	200	1	1	1	7035	



estante para teclado

Kit de ruedas



ART.	Ø mm	KG	KG	H mm	material			
FKRU1252101	125	100	300	155	Goma antihuella sintética	-	2	2
FKRV1001107	100	150	450	128	Nailon	1	1	2



RUEDA GIRATORIA



RUEDA GIRATORIA CON FRENO



RUEDA FIJA



Estante extraíble de extracción flexible con asa Dark Grey 36x27 EH

ART.	dim. útiles		RAL
	A mm	P mm	
M32C05701101F39	602	449	7016



Estante regulable con soportes 36x27 EH

ART.	A mm	P mm	H mm	RAL
M32PR2500001139	663	560	52	7016



Asa de tubo

ART.	A mm	P mm	H mm	RAL
M02R00000000007	484	80	46	9005



Ventilador 230V sin rejilla con clavija Schuko

ART.	A mm	P mm	H mm	color
FAS32200100	125	44	125	Negro



Encimera de 3 bordes revestida de PVC con orificio pasacables 36x27 EH

ART.	A mm	P mm	H mm	color
M32T023AG007107	715	576	31	Negro



Soporte de toma

ART.	A mm	P mm	H mm	Acabado
FAS30210099	542	10	77	Galvanizado

Ejemplos de esquema de tomas múltiples en Soporte de toma



Con toma múltiple de 4 puestos



Con toma múltiple de 2 puestos + toma múltiple de 4 puestos



Con interruptor magnetotérmico + toma múltiple de 4 puestos



ver página 96



FBLET012007



FBLET004007



FBLET005007



FBLET016007

GALVANIZADO

RAL 7035

RAL 7016

RAL 9005

CAPACIDAD



Armario para ordenador con ruedas

ART.	A mm	P mm	H mm	set de ruedas	RAL	
STANDARDCS01	807	654	1688	450	7035	

Compuesto por:

cant.	descripción
1	Armario para ordenador
1	Asa de tubo
1	Soporte de toma
1	Estante extraíble de extracción simple
1	Toma múltiple Schuko de 4 compartimentos
1	Cable de conexión Wieland Schuko/FR
1	Ventilador 230V sin rejilla con clavija Schuko
1	Kit de ruedas de nailon Ø 100 mm



Armario para ordenador

ART.	A mm	P mm	H mm		N. estantes porta teclado	N. estantes regulables	RAL	
FAS1600C00208	717	635	1560	400	1	2	7035	
FAS1600C00204	717	635	1560	400	1	2	5012	

Kit de ruedas



ART.	Ø mm	KG	KG	H mm	material			
FKRU1252101	125	100	300	155	Goma antihuella sintética	-	2	2
FKRV1001107	100	150	450	128	Nailon	1	1	2



RUEDA GIRATORIA



RUEDA GIRATORIA CON FRENO



RUEDA FIJA

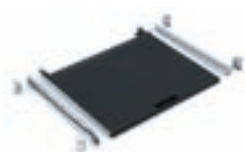

Estante extraíble de extracción simple

ART.	A mm	P mm	H mm	RAL
FAS2360S039	650	582	36	7016

Estante regulable con ganchos

ART.	A mm	P mm	H mm	RAL
FAS2040S139	688	591	38	7016



Asa de tubo

ART.	A mm	P mm	H mm	RAL
FCL09950007	502	80	46	9005

Ventilador 230V sin rejilla con clavija Schuko

ART.	A mm	P mm	H mm	color
FAS32200100	125	44	125	Negro



Par de zócalos

ART.	A mm	P mm	H mm	RAL
FRR16250007	59	608	100	9005

Soporte de toma

ART.	A mm	P mm	H mm	Acabado
FAS30210099	542	10	77	Galvanizado

Ejemplos de esquema de tomas múltiples en Soporte de toma



Con toma múltiple de 4 puestos



Con toma múltiple de 2 puestos + toma múltiple de 4 puestos



Con interruptor magnetotérmico + toma múltiple de 4 puestos

IRON TEAM

ver página 96



FBLET012007



FBLET004007



FBLET005007



FBLET016007

GALVANIZADO

RAL 5012

RAL 7035

RAL 7016

RAL 9005

CAPACIDAD

PERFOM

ARMARIOS DE PUERTAS BATIENTES



Configurable



**Capacidad
800/1200 kg**

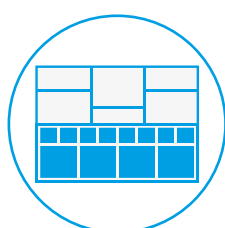

**Material de
separación**



Cierre con llave

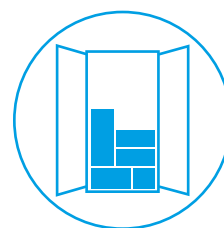

**Armario montado +
accesorios
embalados en el
interior del armario**



ART.	A mm	P mm	H mm	KG	RAL
PERFOM15001	1193	555	1000	800	7035+7016
PERFOM15002	1193	555	1000	800	7035
PERFOM15003	1193	555	1000	800	5012

Compuesto por:

cant.	descripción
1	Armario de puertas batientes
1	Kit de 2 estantes ranurados



ART.	A mm	P mm	H mm	KG	RAL
PERFOM15004	1193	555	1000	800	7035+7016
PERFOM15005	1193	555	1000	800	7035
PERFOM15006	1193	555	1000	800	5012

Compuesto por:

cant.	descripción
1	Armario de puertas batientes
1	Cajón de extracción telescópica H=100 mm
1	Kit de 2 estantes ranurados



ART.	A mm	P mm	H mm	KG	RAL
PERFOM15007	1193	555	1000	800	7035+7016
PERFOM15008	1193	555	1000	800	7035
PERFOM15009	1193	555	1000	800	5012

Compuesto por:

cant.	descripción
1	Armario de puertas batientes
2	Cajón de extracción telescópica H=100 mm
1	Kit de 2 estantes ranurados



ART.	A mm	P mm	H mm	KG	RAL
PERFOM15010	1193	555	1000	800	7035+7016
PERFOM15011	1193	555	1000	800	7035
PERFOM15012	1193	555	1000	800	5012

Compuesto por:

cant.	descripción
1	Armario de puertas batientes
3	Cajón de extracción telescópica H=100 mm
1	Estante ranurado



RAL 5012



RAL 7035



RAL 7035 + RAL 7016



CAPACIDAD



ART.	A mm	P mm	H mm		RAL	
PERFOM17001	1193	555	2000	1200	7035+7016	
PERFOM17002	1193	555	2000	1200	7035	
PERFOM17003	1193	555	2000	1200	5012	

Compuesto por:

cant.	descripción
1	Armario de puertas batientes
2	Kit de 2 estantes ranurados



ART.	A mm	P mm	H mm		RAL	
PERFOM17004	1193	555	2000	1200	7035+7016	
PERFOM17005	1193	555	2000	1200	7035	
PERFOM17006	1193	555	2000	1200	5012	

Compuesto por:

cant.	descripción
1	Armario de puertas batientes
3	Cajón de extracción telescópica H=100 mm
2	Kit de 2 estantes ranurados



ART.	A mm	P mm	H mm		RAL	
PERFOM17007	1193	555	2000	1200	7035+7016	
PERFOM17008	1193	555	2000	1200	7035	
PERFOM17009	1193	555	2000	1200	5012	

Compuesto por:

cant.	descripción
1	Armario de puertas batientes
9	Cajón de extracción telescópica H=100 mm
1	Kit de 2 estantes ranurados



ART.	A mm	P mm	H mm	KG	RAL	
PERFOM11001	512	555	1000	800	7035+7016	
FAA1120C00108	512	555	1000	800	7035	
FAA1120C00104	512	555	1000	800	5012	

Compuesto por:

cant.	descripción
1	Armario de puerta batiente
1	Kit de 2 estantes ranurados



ART.	A mm	P mm	H mm	KG	RAL	
PERFOM11004	512	555	1000	800	7035+7016	
PERFOM11005	512	555	1000	800	7035	
PERFOM11006	512	555	1000	800	5012	

Compuesto por:

cant.	descripción
1	Armario de puerta batiente
1	Cajón de extracción simple H=100 mm
1	Kit de 2 estantes ranurados



ART.	A mm	P mm	H mm	KG	RAL	
PERFOM11010	512	555	1000	800	1004	
PERFOM11011	512	555	1000	800	7035+7016	
PERFOM11012	512	555	1000	800	7035	
PERFOM11013	512	555	1000	800	5012	

Compuesto por:

cant.	descripción
1	Armario de puertas batientes ranuradas
1	Kit de 2 cubas estancas internas colectoras de líquidos capacidad 9 L



ver página 256



ART.	A mm	P mm	H mm	KG	RAL	
PERFOM11017	519	555	1409	225	7035+7016	
PERFOM11018	519	555	1409	225	7035	
PERFOM11019	519	555	1409	225	5012	

Compuesto por:

cant.	descripción
1	Armario de puerta batiente
1	Atril
1	Cajón de extracción simple H=100 mm
1	Kit de 2 estantes ranurados
1	Par placas portaruedas
1	Kit de ruedas de goma standard Ø 100 mm



ART.	A mm	P mm	H mm	KG	RAL
PERFOM12001	1023	555	1000	800	7035+7016
FAA1220C00108	1023	555	1000	800	7035
FAA1220C00104	1023	555	1000	800	5012

Compuesto por:

cant.	descripción
1	Armario de puertas batientes
1	Kit de 2 estantes ranurados



ART.	A mm	P mm	H mm	KG	RAL
PERFOM12004	1023	555	1000	800	7035+7016
PERFOM12005	1023	555	1000	800	7035
PERFOM12006	1023	555	1000	800	5012

Compuesto por:

cant.	descripción
1	Armario de puertas batientes
1	Cajón de extracción simple H=100 mm
1	Kit de 2 estantes ranurados



ART.	A mm	P mm	H mm	KG	RAL
PERFOM12007	1023	555	1000	800	7035+7016
PERFOM12008	1023	555	1000	800	7035
PERFOM12009	1023	555	1000	800	5012

Compuesto por:

cant.	descripción
1	Armario de puertas batientes
3	Cajón de extracción simple H=100 mm
1	Estante ranurado



ART.	A mm	P mm	H mm	KG	RAL
PERFOM12010	1023	555	1000	800	7035+7016
PERFOM12011	1023	555	1000	800	7035
PERFOM12012	1023	555	1000	800	5012

Compuesto por:

cant.	descripción
1	Armario de puertas batientes ranuradas
1	Kit de 2 estantes/paneles perforados
1	Canaleta eléctrica para tomas múltiples
2	Toma múltiple Schuko de 2 compartimentos
1	Toma múltiple Schuko de 4 compartimentos
1	Magnetotérmico diferencial
1	Cable de conexión Wieland Schuko/FR





ART.	A mm	P mm	H mm	KG	RAL	
PERFOM12013	1048	600	1027	800	1004	
PERFOM12014	1048	600	1027	800	7035+7016	
PERFOM12015	1048	600	1027	800	7035	
PERFOM12016	1048	600	1027	800	5012	

Compuesto por:

cant.	descripción
1	Armario de puertas batientes ranuradas
1	Estante ranurado
1	Cuba estanca externa colectora de líquidos capacidad 59 L



ver página 256



ART.	A mm	P mm	H mm	KG	RAL	
PERFOM12017	1023	555	1000	800	1004	
PERFOM12018	1023	555	1000	800	7035+7016	
PERFOM12019	1023	555	1000	800	7035	
PERFOM12020	1023	555	1000	800	5012	

Compuesto por:

cant.	descripción
1	Armario de puertas batientes ranuradas
1	Kit de 2 cubas estancas internas colectoras de líquidos capacidad 19 L



ver página 256



ART.	A mm	P mm	H mm	KG	RAL	
PERFOM12025	1048	600	1027	800	6011	

Compuesto por:

cant.	descripción
1	Armario de puertas batientes ranuradas
1	Estante ranurado
1	Cuba estanca externa colectora de líquidos capacidad 59 L



ver página 256



ART.	A mm	P mm	H mm	KG	RAL	
PERFOM12021	1023	555	1000	800	3020	
PERFOM12022	1023	555	1000	800	7035+7016	
PERFOM12023	1023	555	1000	800	7035	
PERFOM12024	1023	555	1000	800	5012	

Compuesto por:

cant.	descripción
1	Armario de puertas batientes ranuradas
1	Kit de 2 estantes ranurados



RAL 6011



RAL 1004



RAL 3020



RAL 5012



RAL 7035



RAL 7035 + RAL 7016



CAPACIDAD



ART.	A mm	P mm	H mm	KG	RAL
PERFOM14001	1023	555	2000	1200	7035+7016
FAA1420C00108	1023	555	2000	1200	7035
FAA1420C00104	1023	555	2000	1200	5012

Compuesto por:

cant.	descripción
1	Armario de puertas batientes
1	Kit de 4 estantes ranurados



ART.	A mm	P mm	H mm	KG	RAL
PERFOM14004	1023	555	2000	1200	7035+7016
PERFOM14005	1023	555	2000	1200	7035
PERFOM14006	1023	555	2000	1200	5012

Compuesto por:

cant.	descripción
1	Armario de puertas batientes
3	Cajón de extracción simple H=100 mm
1	Kit de 4 estantes ranurados



ART.	A mm	P mm	H mm	KG	RAL
PERFOM14007	1023	555	2000	1200	7035+7016
PERFOM14008	1023	555	2000	1200	7035
PERFOM14009	1023	555	2000	1200	5012

Compuesto por:

cant.	descripción
1	Armario de puertas batientes ranuradas de policarbonato
1	Kit de 4 estantes ranurados



ART.	A mm	P mm	H mm	KG	RAL	
PERFOM14019	1023	555	2000	1200	7035+7016	
PERFOM14020	1023	555	2000	1200	7035	
PERFOM14021	1023	555	2000	1200	5012	

Compuesto por:

cant.	descripción
1	Armario de puertas batientes ranuradas
1	Cuba estanca interna colectora de líquidos, capacidad 19 L
1	Kit de estante ranurado con 2 separadores y 6 bidones con grifo de bola
1	Kit de 2 estantes ranurados



ART.	A mm	P mm	H mm	KG	RAL	
PERFOM14022	1048	600	2027	1200	7035+7016	
PERFOM14023	1048	600	2027	1200	7035	
PERFOM14024	1048	600	2027	1200	5012	

Compuesto por:

cant.	descripción
1	Armario de puertas batientes ranuradas
1	Cuba estanca interna colectora de líquidos, capacidad 19 L
3	Kit de estante ranurado con 2 separadores y 6 bidones con grifo de bola
1	Estante ranurado
1	Cuba estanca externa colectora de líquidos capacidad 59 L





ART.	A mm	P mm	H mm	KG	RAL	
PERFOM14056	1048	600	2027	1200	6011	

Compuesto por:

cant.	descripción
1	Armario de puertas batientes ranuradas
1	Kit de 3 estantes ranurados
1	Cuba estanca externa colectora de líquidos capacidad 59 L



ver página 256



ART.	A mm	P mm	H mm	KG	RAL	
PERFOM14057	1023	555	2000	1200	6011	

Compuesto por:

cant.	descripción
1	Armario de puertas batientes ranuradas
2	Kit de 2 cubas estancas internas colectoras de líquidos capacidad 19 L



ver página 256



ART.	A mm	P mm	H mm	KG	RAL	
PERFOM14058	1023	555	2000	1200	7035	

Compuesto por:

cant.	descripción
1	Armario de puertas batientes ranuradas de policarbonato
2	Kit de 2 cubas estancas internas colectoras de líquidos capacidad 19 L



ver página 256



ART.	A mm	P mm	H mm	KG	RAL	
PERFOM14025	1048	600	2027	1200	1004	
PERFOM14026	1048	600	2027	1200	7035+7016	
PERFOM14027	1048	600	2027	1200	7035	
PERFOM14028	1048	600	2027	1200	5012	

Compuesto por:

cant.	descripción
1	Armario de puertas batientes ranuradas
1	Kit de 3 estantes ranurados
1	Cuba estanca externa colectora de líquidos capacidad 59 L



ver página 256



ART.	A mm	P mm	H mm	KG	RAL	
PERFOM14029	1023	555	2000	1200	1004	
PERFOM14030	1023	555	2000	1200	7035+7016	
PERFOM14031	1023	555	2000	1200	7035	
PERFOM14032	1023	555	2000	1200	5012	

Compuesto por:

cant.	descripción
1	Armario de puertas batientes ranuradas
2	Kit de 2 cubas estancas internas colectoras de líquidos capacidad 19 L



ver página 256



ART.	A mm	P mm	H mm	RAL	
PERFOM14033	1023	555	2000	3020	

Compuesto por:

cant.	descripción
1	Armario de puertas batientes ranuradas safe crash
1	Kit de 3 estantes ranurados
1	Estante-panel perforado
1	Tabique divisor
1	Kit tubo percha



RAL 6011



RAL 1004



RAL 3020



RAL 5012



RAL 7035



RAL 7035 + RAL 7016



CAPACIDAD



ART.	A mm	P mm	H mm	KG	RAL
PERFOM14034	1023	555	2000	1200	7035+7016
PERFOM14035	1023	555	2000	1200	7035
PERFOM14036	1023	555	2000	1200	5012

Compuesto por:

cant.	descripción
1	Armario de puertas batientes ranuradas
2	Kit de 2 estantes/paneles perforados
2	Canaleta eléctrica para tomas múltiples
1	Rejilla para ventiladores
2	Ventilador 230V sin rejilla con clavija Schuko
4	Toma múltiple Schuko de 2 compartimentos
3	Toma múltiple Schuko de 4 compartimentos

cant.	descripción
1	Magnetotérmico diferencial
1	Cable de conexión Wieland con clavijas in/out
2	Cable de conexión Wieland Schuko/FR
1	Kit porta rollo con papel Ø=240 mm
1	Gancho Unipok para herramientas - paquete de 30 unidades
2	Repisa grande reversible



ART.	A mm	P mm	H mm	KG	RAL	
PERFOM14037	1023	555	2000	1200	7035+7016	
PERFOM14038	1023	555	2000	1200	7035	
PERFOM14039	1023	555	2000	1200	5012	

Compuesto por:

cant.	descripción
1	Armario de puertas batientes ranuradas de policarbonato
2	Kit de 2 estantes/paneles perforados
3	Canaleta eléctrica para tomas múltiples
6	Toma múltiple Schuko de 2 compartimentos
3	Toma múltiple Schuko de 4 compartimentos
1	Magnetotérmico diferencial
2	Cable de conexión Wieland con clavijas in/out
1	Cable de conexión Wieland Schuko/FR



ART.	A mm	P mm	H mm	KG	RAL	
PERFOM14040	1023	555	2000	1200	7035+7016	
PERFOM14041	1023	555	2000	1200	7035	
PERFOM14042	1023	555	2000	1200	5012	

Compuesto por:

cant.	descripción
1	Armario de puertas batientes ranuradas
2	Kit de 2 estantes/paneles perforados
2	Canaleta eléctrica para tomas múltiples
2	Barra gancho contenedores Picking Box tamaño 1/2
6	Contenedor de polipropileno Picking Box tamaño 2
4	Toma múltiple Schuko de 2 compartimentos
2	Toma múltiple Schuko de 4 compartimentos
1	Magnetotérmico diferencial
1	Cable de conexión Wieland con clavijas in/out
1	Cable de conexión Wieland Schuko/FR
1	Kit porta rollo con papel Ø=240 mm
2	Gancho Unipok para herramientas - paquete de 30 unidades
2	Repisa grande reversible



ART.	A mm	P mm	H mm	KG	RAL	
PERFOM14043	1023	555	2000	1200	7035+7016	
PERFOM14044	1023	555	2000	1200	7035	
PERFOM14045	1023	555	2000	1200	5012	

Compuesto por:

cant.	descripción
1	Armario de puertas batientes ranuradas
2	Kit de 2 estantes/paneles perforados
2	Canaleta eléctrica para tomas múltiples
2	Toma múltiple Schuko de 2 compartimentos
2	Toma múltiple Schuko de 4 compartimentos
1	Cable de conexión Wieland con clavijas in/out
1	Cable de conexión Wieland Schuko/FR



RAL 5012



RAL 7035



RAL 7035 + RAL 7016



CAPACIDAD



ART.	A mm	P mm	H mm	KG	RAL
PERFOM14046	1023	555	2000	1200	7035+7016
PERFOM14047	1023	555	2000	1200	7035
PERFOM14048	1023	555	2000	1200	5012

Compuesto por:

cant.	descripción
1	Armario de puertas batientes
3	Cajón de extracción simple H=100 mm
2	Par de paneles perforados para puertas batientes
2	Kit de 2 estantes/paneles perforados
14	Barra gancho contenedores Picking Box tamaño 1/2
40	Contenedor de polipropileno Picking Box tamaño 1
12	Contenedor de polipropileno Picking Box tamaño 2
1	Kit porta rollo con papel Ø=240 mm
4	Gancho Unipok para herramientas - paquete de 30 unidades
2	Repisa grande reversible



ART.	A mm	P mm	H mm	KG	RAL
PERFOM14049	1023	555	2000	1200	7035+7016
PERFOM14050	1023	555	2000	1200	7035
PERFOM14051	1023	555	2000	1200	5012

Compuesto por:

cant.	descripción
1	Armario de puertas batientes
3	Cajón de extracción simple H=100 mm
2	Kit de 2 estantes/paneles perforados
4	Barra gancho contenedores Picking Box tamaño 1/2
12	Contenedor de polipropileno Picking Box tamaño 2
4	Gancho Unipok para herramientas - paquete de 30 unidades



ART.	A mm	P mm	H mm	KG	RAL
PERFOM14052	1023	555	2000	1200	7035+7016
PERFOM14053	1023	555	2000	1200	7035
PERFOM14054	1023	555	2000	1200	5012

Compuesto por:

cant.	descripción
1	Armario de puertas batientes
3	Cajón de extracción simple H=100 mm
4	Cajón de extracción telescópica H=150 mm
1	Kit de 2 estantes ranurados



ART.	A mm	P mm	H mm	KG	RAL	
PERFOM14010	1023	555	2000	1200	7035+7016	
PERFOM14011	1023	555	2000	1200	7035	
PERFOM14012	1023	555	2000	1200	5012	

Compuesto por:

cant.	descripción
1	Armario de puertas batientes ranuradas
1	Kit de 3 estantes ranurados
1	Estante-panel perforado
1	Tabique divisor
1	Kit tubo percha



ART.	A mm	P mm	H mm	KG	RAL	
PERFOM14013	1023	555	2000	1200	7035+7016	
PERFOM14014	1023	555	2000	1200	7035	
PERFOM14015	1023	555	2000	1200	5012	

Compuesto por:

cant.	descripción
1	Armario de puertas batientes
1	Kit de 2 estantes ranurados con guías
1	Kit de 3 estantes ranurados con guías
1	Par de paneles perforados para puertas batientes
1	Kit de 3 estantes ranurados
10	Barra gancho contenedores Picking Box tamaño 1/2
40	Contenedor de polipropileno Picking Box tamaño 1
5	Contenedor de polipropileno Picking Box tamaño 2
6	Contenedor de polipropileno Picking Box tamaño 4
20	Contenedor de polipropileno Picking Box tamaño 3A2
6	Contenedor de polipropileno Picking Box tamaño 4A2



ART.	A mm	P mm	H mm	KG	RAL	
PERFOM14016	1023	555	2000	1200	7035+7016	
PERFOM14017	1023	555	2000	1200	7035	
PERFOM14018	1023	555	2000	1200	5012	

Compuesto por:

cant.	descripción
1	Armario de puertas batientes
3	Cajón de extracción simple H=100 mm
2	Kit de 2 estantes ranurados con guías
1	Par de paneles perforados para puertas batientes
1	Estante ranurado
1	Estante-panel perforado
16	Barra gancho contenedores Picking Box tamaño 1/2
40	Contenedor de polipropileno Picking Box tamaño 1
23	Contenedor de polipropileno Picking Box tamaño 2
20	Contenedor de polipropileno Picking Box tamaño 3A2



RAL 5012



RAL 7035



RAL 7035 + RAL 7016



CAPACIDAD

Armarios de puertas batientes



Armario de puertas batientes 64x27 EH

ART.	A mm	P mm	H mm	KG	RAL	
FAA1520C000PD	1193	555	1000	800	7035+7016	
FAA1520C00008	1193	555	1000	800	7035	
FAA1520C00004	1193	555	1000	800	5012	



Armario de puertas batientes 64x27 EH

ART.	A mm	P mm	H mm	KG	RAL	
FAA1720C000PD	1193	555	2000	1200	7035+7016	
FAA1720C00008	1193	555	2000	1200	7035	
FAA1720C00004	1193	555	2000	1200	5012	

Armarios de puertas batientes



Armario de puertas batientes 24x27 EH

ART.	A mm	P mm	H mm	KG	RAL	
FAA1120C000PD	512	555	1000	800	7035+7016	
FAA1120C00008	512	555	1000	800	7035	
FAA1120C00004	512	555	1000	800	5012	



Armario de puertas batientes ranuradas 24x27 EH

ART.	A mm	P mm	H mm	KG	RAL	
FAA1130C00030	512	555	1000	800	1004	
FAA1130C000PD	512	555	1000	800	7035+7016	
FAA1130C00008	512	555	1000	800	7035	
FAA1130C00004	512	555	1000	800	5012	



Armario de puertas batientes 54x27 EH

ART.	A mm	P mm	H mm	KG	RAL	
FAA1220C000PD	1023	555	1000	800	7035+7016	
FAA1220C00008	1023	555	1000	800	7035	
FAA1220C00004	1023	555	1000	800	5012	



Armario de puertas batientes ranuradas 54x27 EH

ART.	A mm	P mm	H mm	KG	RAL	
FAA1230C00030	1023	555	1000	800	1004	
FAA1230C0002Y	1023	555	1000	800	3020	
FAA1230C000PD	1023	555	1000	800	7035+7016	
FAA1230C00008	1023	555	1000	800	7035	
FAA1230C00004	1023	555	1000	800	5012	
FAA1230C00002	1023	555	1000	800	6011	



RAL 6011



RAL 1004



RAL 3020



RAL 5012



RAL 7035



RAL 7035 + RAL 7016



CAPACIDAD

Armarios de puertas batientes



Armario de puertas batientes 54x27 EH

ART.	A mm	P mm	H mm	KG	RAL	
FAA1420C000PD	1023	555	2000	1200	7035+7016	
FAA1420C00008	1023	555	2000	1200	7035	
FAA1420C00004	1023	555	2000	1200	5012	



Armario de puertas batientes ranuradas 54x27 EH

ART.	A mm	P mm	H mm	KG	RAL	
FAA1430C00030	1023	555	2000	1200	1004	
FAA1430C000PD	1023	555	2000	1200	7035+7016	
FAA1430C00008	1023	555	2000	1200	7035	
FAA1430C00004	1023	555	2000	1200	5012	
FAA1430C00002	1023	555	2000	1200	6011	



Armarios de puertas batientes



Armario de puertas batientes ranuradas de policarbonato 54x27 EH

ART.	A mm	P mm	H mm	KG	RAL	
FAA1440C000PD	1023	555	2000	1200	7035+7016	
FAA1440C00008	1023	555	2000	1200	7035	
FAA1440C00004	1023	555	2000	1200	5012	



Armario de puertas batientes ranuradas safe crash 54x27 EH

ART.	A mm	P mm	H mm	KG	RAL	
FAA1440C05C2Y	1023	555	2000	1200	3020	



- 
RAL 6011
- 
RAL 1004
- 
RAL 3020
- 
RAL 5012
- 
RAL 7035
- 
RAL 7035 + RAL 7016
- 
CAPACIDAD

Armarios de puertas batientes



Encimera de 3 bordes revestida de pvc

ART.	A mm	P mm	H mm	color
FAC9911290007	514	558	31	Negro
FAC9912290007	1024	558	31	Negro
FAC9915290007	1194	558	31	Negro



Top de acero de goma

ART.	A mm	P mm	H mm	color
FAC9911360007	512	555	32	Negro
FAC9912360007	1023	555	32	Negro
FAC9915360007	1193	555	32	Negro

Estante ranurado P=500 mm

ART.	A mm	P mm	H mm	KG	Acabado
FAC9911010099	484	500	35	120	Galvanizado
FAC9912010099	995	500	35	120	Galvanizado
FAC9915010099	1165	500	35	120	Galvanizado



Kit de estantes ranurados P=500 mm

ART.	A mm	P mm	H mm	n.º estantes	KG	Acabado
FAC9911020099	484	500	35	2	120	Galvanizado
FAC9911030099	484	500	35	3	120	Galvanizado
FAC9912020099	995	500	35	2	120	Galvanizado
FAC9912030099	995	500	35	3	120	Galvanizado
FAC9912040099	995	500	35	4	120	Galvanizado
FAC9915020099	1165	500	35	2	120	Galvanizado
FAC9915030099	1165	500	35	3	120	Galvanizado



Kit de estantes ranurados P=345 mm

ART.	A mm	P mm	H mm	n.º estantes	KG	Acabado
FAC9912050099	995	345	35	2	100	Galvanizado
FAC9912060099	995	345	35	3	100	Galvanizado



Armarios de puertas batientes

Estante-panel perforado

Aplicable en 3 posiciones:

Panel perforado vertical

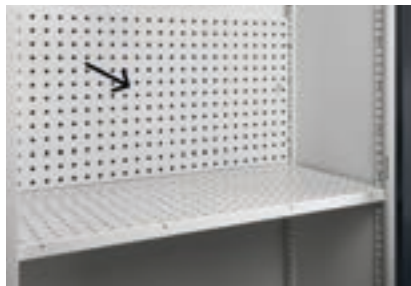

Estante horizontal



Repisa perforada con 4 bordes



Estante-panel perforado

ART.	A mm	P mm	H mm	 KG	Medida del orificio (mm)	Paso mm	RAL
FAC9912070039	995	500	30	120-50	10x10	38	7016
FAC9912070008	995	500	30	120-50	10x10	38	7035
FAC9912070004	995	500	30	120-50	10x10	38	5012

Kit de estantes-panes perforados

ART.	A mm	P mm	H mm	n.º estantes	 KG	Medida del orificio (mm)	Paso mm	RAL
FAC9912080008	995	500	30	2	120-50	10x10	38	7035
FAC9912080004	995	500	30	2	120-50	10x10	38	5012
FAC9912080039	995	500	30	2	120-50	10x10	38	7016



Barras gancho contenedores con 4 contenedores Picking Box tamaño 1

ART.	A mm	P mm	H mm	color de los contenedores
FBLIT011000	445	168	85	Gris oscuro
FBLIT029000	445	168	85	Azul



Par de paneles perforados para puertas batientes

Se puede aplicar un máximo de un par de paneles por cada puerta

ART.	A mm	P mm	H mm	Medida del orificio (mm)	Paso mm	RAL
FAC9912250039	381	20	824	10x10	38	7016

 GALVANIZADO
  RAL 5012
  RAL 7035
  RAL 7016
  CAPACIDAD



Cajones de extracción simple 24x27 EH

ART.	dim. útiles			KG	Icono	H frontal cajón mm	RAL	
	A mm	P mm	H mm					
FAC9911180008	398	449	85	50	88%	100	7035	
FAC9911180004	398	449	85	50	88%	100	5012	
FAC9911180039	398	449	85	50	88%	100	7016	



Cajones de extracción simple 54x27 EH

ART.	dim. útiles			KG	Icono	H frontal cajón mm	RAL	
	A mm	P mm	H mm					
FAC9912180008	908	449	85	50	88%	100	7035	
FAC9912180004	908	449	85	50	88%	100	5012	
FAC9912180039	908	449	85	50	88%	100	7016	



Cajones de extracción telescópica 54x27 EH

ART.	dim. útiles			KG	Icono	H frontal cajón mm	RAL	
	A mm	P mm	H mm					
FAC9912190008	908	449	85	100	100%	100	7035	
FAC9912190004	908	449	85	100	100%	100	5012	
FAC9912190039	908	449	85	100	100%	100	7016	
FAC9912210008	908	449	135	100	100%	150	7035	
FAC9912210004	908	449	135	100	100%	150	5012	
FAC9912210039	908	449	135	100	100%	150	7016	



Cajones de extracción telescópica 64x27 EH

ART.	dim. útiles			KG	Icono	H frontal cajón mm	RAL	
	A mm	P mm	H mm					
FAC9915190008	1078	449	85	100	100%	100	7035	
FAC9915190004	1078	449	85	100	100%	100	5012	
FAC9915190039	1078	449	85	100	100%	100	7016	

Armarios de puertas batientes



Zócalo para transpallet con cierre

ART.	A mm	P mm	H mm	KG	RAL	
FAC9912170039	1018	550	100	1200	7016	
FAC9915170039	1188	550	100	1200	7016	



Cuba estanca externa colectora de líquidos capacidad 59 L

ART.	A mm	P mm	H mm	KG	L	RAL	
FAC9912130039	1048	600	167	1200	59	7016	



ver página 256

Cubas estancas internas colectoras de líquidos



ART.	A mm	P mm	H mm	KG	L	Acabado	
FAC9911090099	484	500	42	50	9	Galvanizado	
FAC9912090099	995	500	42	50	19	Galvanizado	

Kit de cubas estancas internas colectoras de líquidos

ART.	A mm	P mm	H mm	KG	L	N. cubas	Acabado	
FAC9911100099	484	500	42	50	9	2	Galvanizado	
FAC9912100099	995	500	42	50	19	2	Galvanizado	



Kit de estante ranurado con 2 separadores y 6 bidones con grifo de bola

ART.	A mm	P mm	H mm	N. bidones	L bidones	Acabado estante	
FAC9912280099	995	495	315	6	10	Galvanizado	

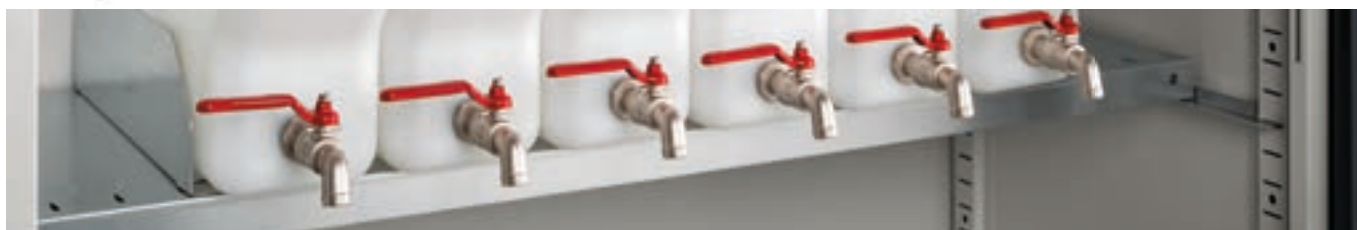

GALVANIZADO



RAL 5012



RAL 7035



RAL 7016



CAPACIDAD



CAPACIDAD



EXTRACCIÓN

Armarios de puertas batientes



Canaleta eléctrica para tomas múltiples

ART.	A mm	P mm	H mm	RAL	
FAC9912220039	1008	64	140	7016	



Esquema de tomas múltiples para canaleta eléctrica



- 1
- 2
- 3
- 3
- 4

- 1 magnetotérmico
- 2 toma múltiple de 4 compartimentos
- 3 toma múltiple de 2 compartimentos
- 4 USB recarga



Aplicación canaleta eléctrica en la **parte superior** del **estante-panel perforado**



Aplicación canaleta eléctrica en la **parte inferior** del **estante-panel perforado**



Canaleta eléctrica **integrable** con **estante-panel perforado** en posición vertical



Soporte lateral para toma múltiple

ART.	A mm	P mm	H mm	RAL	
FAC9912240039	10	463	77	7016	

Esquema de tomas múltiples para soporte lateral



toma múltiple de 4 compartimentos



Ejemplo de aplicación con:
 1 soporte art. FAC9912240039
 1 toma múltiple art. FBLET005007
 1 cable de conexión art. FBLET016007

Armarios de puertas batientes



Rejilla para ventiladores

ART.	A mm	P mm	H mm	RAL
FAC9912230039	994	123	136	7016

Ejemplo de aplicación con:
 1 rejilla art. FAC9912230039
 2 ventiladores art. FAS32200100
 1 toma múltiple art. FBLET005007
 1 cable de conexión art. FBLET016007



Aplicación de la rejilla en la **parte superior** del armario **sin** la ayuda del **estante-panel perforado**



Aplicación de la rejilla en la **parte superior** del armario **con** la ayuda del **estante-panel perforado**



Aplicación de la rejilla en la **parte inferior** del armario **con** la ayuda del **estante-panel perforado**



Ventilador 230V sin rejilla con clavija Schuko

ART.	A mm	P mm	H mm	color
FAS32200100	125	44	125	Negro



ver página 96



FBLET012007



FBLET004007



FBLET005007



FBLET016007



FBLET014007



FBLET020007



FBL99400008

Aplicación de la lámpara bajo el estante-panel perforado



Armarios de puertas batientes



1. Atril
2. Cajón de extracción simple H=100 mm
3. Par placas portaruedas
4. Kit de ruedas de goma standard Ø 100 mm



Atril

ART.	A mm	P mm	H mm	RAL
FAC9911340004	516	564	316	5012
FAC9911340008	516	564	316	7035
FAC9911340039	516	564	316	7016

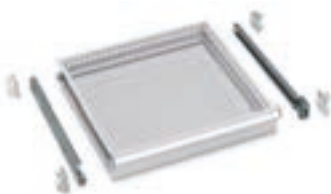

Cajones de extracción simple 24x27 EH

ART.	dim. útiles			KG	%	H frontal cajón mm	RAL
	A mm	P mm	H mm				
FAC9911180008	398	449	85	50	88%	100	7035
FAC9911180004	398	449	85	50	88%	100	5012
FAC9911180039	398	449	85	50	88%	100	7016



Pared de cierre delantero para atril

ART.	A mm	P mm	H mm	RAL
FAC9911350004	454	60	101	5012
FAC9911350008	454	60	101	7035
FAC9911350039	454	60	101	7016



Par placas portaruedas

ART.	A mm	P mm	H mm
FAC9911330099	114	550	13



Kit de ruedas

ART.	Ø mm	KG	KG	H mm	material	🔄	🛑
FKRD1002107	100	75	225	128	Goma standard	2	2
FKRB1252107	125	100	300	155	Goma standard	2	2
FKRU1252101	125	100	300	155	Goma antihuella sintética	2	2
FKRS1252101	125	250	750	155	Goma elástica	2	2



RUEDA GIRATORIA CON FRENO



RUEDA FIJA

Armarios de puertas batientes

1. Tabique divisor
2. Kit tubo percha
3. Estante-panel perforado
4. Estante ranurado
5. Cajón de extracción simple H=100 mm

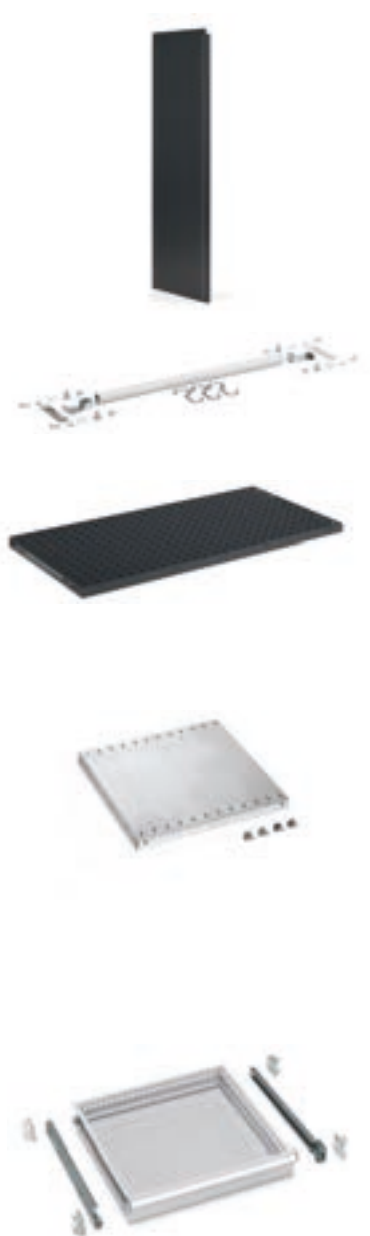
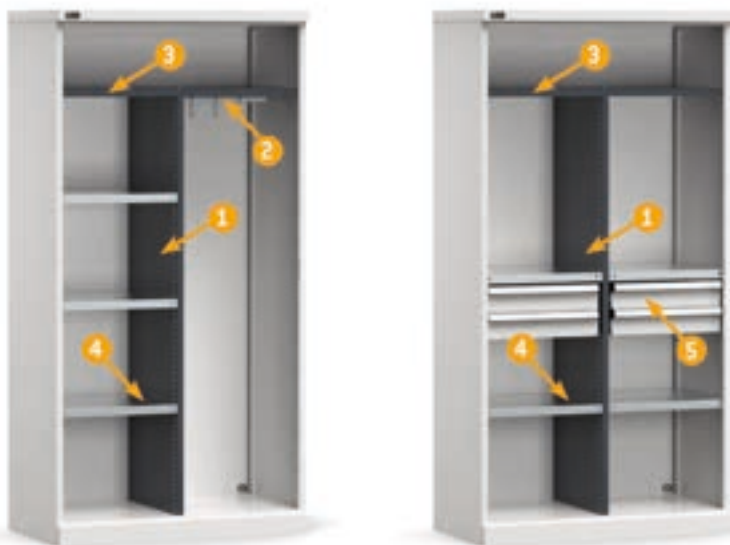

Tabique divisor

ART.	A mm	P mm	H mm	Paso mm	RAL
FAC9912260039	44	500	1616	25	7016

Kit tubo percha

ART.	A mm	P mm	H mm	KG	Acabado
FAC9912270099	458	23	56	15	Galvanizado

Estante-panel perforado

ART.	A mm	P mm	H mm	KG	RAL
FAC9912070039	995	500	30	120-50	7016

Estante ranurado P=500 mm

ART.	A mm	P mm	H mm	KG	Acabado
FAC9911010099	484	500	35	120	Galvanizado

Kit de estantes ranurados P=500 mm

ART.	A mm	P mm	H mm	n.º estantes	KG	Acabado
FAC9911020099	484	500	35	2	120	Galvanizado
FAC9911030099	484	500	35	3	120	Galvanizado

Cajones de extracción simple 24x27 EH

ART.	dim. útiles			KG	EXTRACCIÓN	H frontal cajón mm	RAL
	A mm	P mm	H mm				
FAC9911180008	398	449	85	50	88%	100	7035
FAC9911180004	398	449	85	50	88%	100	5012
FAC9911180039	398	449	85	50	88%	100	7016

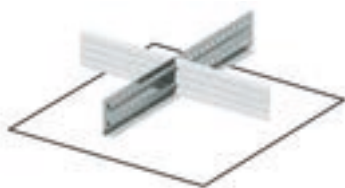
PERFOM**MATERIAL DE SEPARACIÓN****A= 512 MM****24X27 EH**

ART.	apto para cajón H mm	componentes	
FFH00500100	100	2 x Divisor transversal A=202 mm 1 x Separador longitudinal ranurado A=457 mm	

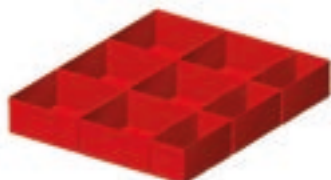

ART.	apto para cajón H mm	componentes	
FFH00500800	100/125	3 x Caja divisor 150x75 mm 6 x Caja divisor 150x150 mm	

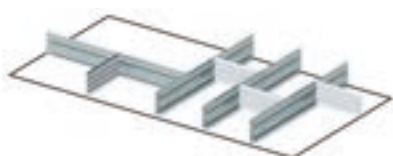

ART.	apto para cajón H mm	componentes	
FFH00500900	100/125	15 x Caja divisor 150x75 mm	

A= 1023 MM**54X27 EH**

ART.	apto para cajón H mm	componentes	
FFH02000100	100	4 x Separador longitudinal ranurado A=457 mm 4 x Divisor trasversal A=151 mm	

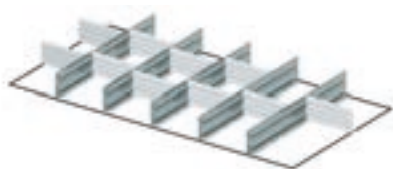

ART.	apto para cajón H mm	componentes	
FFH02000200	100	5 x Separador longitudinal ranura A=457 mm 10 x Divisor trasversal A=151 mm	



ART.	apto para cajón H mm	componentes	
FFH02000600	100/125	12 x Caja divisor 150x75 mm 12 x Caja divisor 150x150 mm	

A= 1193 MM

64X27 EH

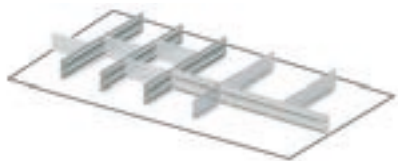

ART.	apto para cajón H mm	componentes	
FFH02500300	100	3 x Separador longitudinal ranurado A=457 mm 1 x Separador longitudinal ranurado A=610 mm 3 x Divisor transversal A=151 mm 2 x Divisor transversal A=168 mm 2 x Divisor transversal A=304 mm	

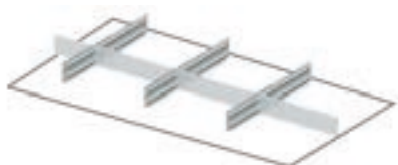

ART.	apto para cajón H mm	componentes	
FFH02500400	100	3 x Separador longitudinal ranurado A=457 mm 1 x Divisor trasversal A=168 mm 3 x Divisor trasversal A=304 mm	

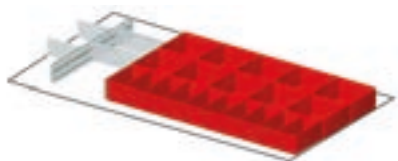

ART.	apto para cajón H mm	componentes	
FFH02500600	100	10 x Caja divisor 150x75 mm 10 x Caja divisor 150x150 mm 2 x Separador longitudinal ranurado A=457 mm 2 x Divisor transversal A=134 mm 2 x Divisor transversal A=202 mm	

PERFOM

ARMARIOS CON PUERTAS CORREDERAS



Capacidad 800/1200 kg



Garantía puertas



Cierre con llave

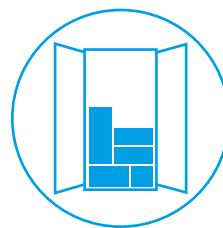

Armario montado +
accesorios embalados
en el interior del armario

PERFOM





ART.	A mm	P mm	H mm	KG	RAL	
PERFOM21001	1020	600	2000	1200	7035+7016	
PERFOM21002	1020	600	2000	1200	7035	
PERFOM21003	1020	600	2000	1200	5012	

Compuesto por:

cant.	descripción
1	Armarios con puertas correderas
1	Kit de 4 estantes ranurados



ART.	A mm	P mm	H mm	KG	RAL	
PERFOM23001	1020	600	2000	1200	7035+7016	

Compuesto por:

cant.	descripción
1	Armario con puertas correderas ranuradas
2	Kit de 2 cubas estancas internas colectoras de líquidos capacidad 19L



ver página 256



ART.	A mm	P mm	H mm	KG	RAL	
PERFOM25001	1020	600	2000	1200	7035+7016	

Compuesto por:

cant.	descripción
1	Armario con puertas correderas ranuradas de policarbonato
1	Kit de 4 estantes ranurados



ART.	A mm	P mm	H mm	KG	RAL	
PERFOM20001	1020	600	915	800	7035+7016	
PERFOM20002	1020	600	915	800	7035	
PERFOM20003	1020	600	915	800	5012	

Compuesto por:

cant.	descripción
1	Armarios con puertas correderas
1	Estante ranurado



ART.	A mm	P mm	H mm	KG	RAL	
PERFOM22001	1020	600	915	800	7035+7016	

Compuesto por:

cant.	descripción
1	Armario con puertas correderas ranuradas
1	Kit de 2 cubas estancas internas colectoras de líquidos capacidad 19 L



ver página 256



ART.	A mm	P mm	H mm	KG	RAL	
PERFOM24001	1020	600	915	800	7035+7016	

Compuesto por:

cant.	descripción
1	Armario con puertas correderas ranuradas de policarbonato
1	Estante ranurado



RAL 5012



RAL 7035



RAL 7035 + RAL 7016



CAPACIDAD



ART.	A mm	P mm	H mm		RAL	
PERFOM21004	1428	600	2000	1200	7035+7016	
PERFOM21005	1428	600	2000	1200	7035	
PERFOM21006	1428	600	2000	1200	5012	

Compuesto por:

cant.	descripción
1	Armarios con puertas correderas
2	Kit de 2 estantes ranurados



ART.	A mm	P mm	H mm		RAL	
PERFOM25002	1428	600	2000	1200	7035+7016	

Compuesto por:

cant.	descripción
1	Armario con puertas correderas ranuradas de policarbonato
2	Kit de 2 estantes ranurados





ART.	A mm	P mm	H mm	KG	RAL	
PERFOM20004	1428	600	915	800	7035+7016	
PERFOM20005	1428	600	915	800	7035	
PERFOM20006	1428	600	915	800	5012	

Compuesto por:

cant.	descripción
1	Armarios con puertas correderas
1	Estante ranurado



ART.	A mm	P mm	H mm	KG	RAL	
PERFOM24002	1428	600	915	800	7035+7016	

Compuesto por:

cant.	descripción
1	Armario con puertas correderas ranuradas de policarbonato
1	Estante ranurado



RAL 5012



RAL 7035



RAL 7035 + RAL 7016



CAPACIDAD



ART.	A mm	P mm	H mm	KG por sector	RAL	
PERFOM21010	2040	600	2000	1200	7035+7016	
PERFOM21011	2040	600	2000	1200	7035	
PERFOM21012	2040	600	2000	1200	5012	

Compuesto por:

cant.	descripción
1	Armarios con puertas correderas
6	Cajón de extracción simple H=100 mm
2	Kit de 4 estantes ranurados



ART.	A mm	P mm	H mm	KG por sector	RAL	
PERFOM23004	2040	600	2000	1200	7035+7016	

Compuesto por:

cant.	descripción
1	Armario con puertas correderas ranuradas
3	Kit de 2 estantes/paneles perforados
1	Estante ranurado
1	Estante interno en multiplex
1	Cajón de extracción simple H=100 mm
2	Canaleta eléctrica para tomas múltiples
1	Soporte lateral para toma múltiple
3	Toma múltiple Schuko de 4 compartimentos
4	Toma múltiple Schuko de 2 compartimentos
2	Cable de conexión Wieland Schuko/FR
1	Cable de conexión Wieland con clavijas in/out
1	Par de escuadras en L
1	Articulación para placa
1	Placa porta monitor de acuerdo con standard VESA
1	Repisa porta objetos reversible



ART.	A mm	P mm	H mm	KG por sector	RAL	
PERFOM25004	2040	600	2000	1200	7035+7016	

Compuesto por:

cant.	descripción
1	Armario con puertas correderas ranuradas de policarbonato
4	Kit de 2 cubas estancas internas colectoras de líquidos capacidad 19 L



ver página 256



ART.	A mm	P mm	H mm	 por sector	RAL	
PERFOM21007	2040	600	2000	1200	7035+7016	
PERFOM21008	2040	600	2000	1200	7035	
PERFOM21009	2040	600	2000	1200	5012	

Compuesto por:

cant.	descripción
1	Armarios con puertas correderas
2	Kit de 4 estantes ranurados



ART.	A mm	P mm	H mm	 por sector	RAL	
PERFOM23003	2040	600	2000	1200	7035+7016	

Compuesto por:

cant.	descripción
1	Armario con puertas correderas ranuradas
4	Kit de 2 cubas estancias internas colectoras de líquidos capacidad 19 L



ver página 256



ART.	A mm	P mm	H mm	 por sector	RAL	
PERFOM25003	2040	600	2000	1200	7035+7016	

Compuesto por:

cant.	descripción
1	Armario con puertas correderas ranuradas de policarbonato
2	Kit de 4 estantes ranurados



RAL 5012



RAL 7035



RAL 7035 + RAL 7016



CAPACIDAD



ART.	A mm	P mm	H mm	 por sector	RAL	
PERFOM20007	2040	600	915	800	7035+7016	
PERFOM20008	2040	600	915	800	7035	
PERFOM20009	2040	600	915	800	5012	

Compuesto por:

cant.	descripción
1	Armarios con puertas correderas
2	Estante ranurado



ART.	A mm	P mm	H mm	 por sector	RAL	
PERFOM22002	2040	600	915	800	7035+7016	

Compuesto por:

cant.	descripción
1	Armario con puertas correderas ranuradas
2	Kit de 2 cubas estancas internas colectoras de líquidos capacidad 19L



ver página 256



ART.	A mm	P mm	H mm	 por sector	RAL	
PERFOM24003	2040	600	915	800	7035+7016	

Compuesto por:

cant.	descripción
1	Armario con puertas correderas ranuradas de policarbonato
2	Estante ranurado

Armarios con puertas correderas



Armarios con puertas correderas 54x27 EH

ART.	A mm	P mm	H mm	KG	RAL	
FAA2010C000PD	1020	600	915	800	7035+7016	
FAA2010C00008	1020	600	915	800	7035	
FAA2010C00004	1020	600	915	800	5012	



Armarios con puertas correderas 78x27 EH

ART.	A mm	P mm	H mm	KG	RAL	
FAA2014C000PD	1428	600	915	800	7035+7016	
FAA2014C00008	1428	600	915	800	7035	
FAA2014C00004	1428	600	915	800	5012	



Armarios con puertas correderas 54+54x27 EH

ART.	A mm	P mm	H mm	KG por sector	RAL	
FAA2020C000PD	2040	600	915	800	7035+7016	
FAA2020C00008	2040	600	915	800	7035	
FAA2020C00004	2040	600	915	800	5012	



Armarios con puertas correderas 54x27 EH

ART.	A mm	P mm	H mm	KG	RAL	
FAA2110C000PD	1020	600	2000	1200	7035+7016	
FAA2110C00008	1020	600	2000	1200	7035	
FAA2110C00004	1020	600	2000	1200	5012	



Armarios con puertas correderas 78x27 EH

ART.	A mm	P mm	H mm	KG	RAL	
FAA2114C000PD	1428	600	2000	1200	7035+7016	
FAA2114C00008	1428	600	2000	1200	7035	
FAA2114C00004	1428	600	2000	1200	5012	



Armarios con puertas correderas 54+54x27 EH

ART.	A mm	P mm	H mm	KG por sector	RAL	
FAA2120C000PD	2040	600	2000	1200	7035+7016	
FAA2120C00008	2040	600	2000	1200	7035	
FAA2120C00004	2040	600	2000	1200	5012	



RAL 5012



RAL 7035



RAL 7035 + RAL 7016



CAPACIDAD

Armarios con puertas correderas



Armario con puertas correderas ranuradas 54x27 EH

ART.	A mm	P mm	H mm	 KG	RAL	
FAA2210C000PD	1020	600	915	800	7035+7016	



Armario con puertas correderas ranuradas 78x27 EH

ART.	A mm	P mm	H mm	 KG	RAL	
FAA2214C000PD	1428	600	915	800	7035+7016	



Armario con puertas correderas ranuradas 54+54x27 EH

ART.	A mm	P mm	H mm	 KG por sector	RAL	
FAA2220C000PD	2040	600	915	800	7035+7016	



Armario con puertas correderas ranuradas 54x27 EH

ART.	A mm	P mm	H mm	 KG	RAL	
FAA2310C000PD	1020	600	2000	1200	7035+7016	



Armario con puertas correderas ranuradas 78x27 EH

ART.	A mm	P mm	H mm	 KG	RAL	
FAA2314C000PD	1428	600	2000	1200	7035+7016	



Armario con puertas correderas ranuradas 54+54x27 EH

ART.	A mm	P mm	H mm	 KG por sector	RAL	
FAA2320C000PD	2040	600	2000	1200	7035+7016	

Armarios con puertas correderas



Armario con puertas correderas ranuradas de policarbonato 54x27 EH

ART.	A mm	P mm	H mm	 KG	RAL	
FAA2410C000PD	1020	600	915	800	7035+7016	



Armario con puertas correderas ranuradas de policarbonato 78x27 EH

ART.	A mm	P mm	H mm	 KG	RAL	
FAA2414C000PD	1428	600	915	800	7035+7016	



Armario con puertas correderas ranuradas de policarbonato 54+54x27 EH

ART.	A mm	P mm	H mm	 KG por sector	RAL	
FAA2420C000PD	2040	600	915	800	7035+7016	



Armario con puertas correderas ranuradas de policarbonato 54x27 EH

ART.	A mm	P mm	H mm	 KG	RAL	
FAA2510C000PD	1020	600	2000	1200	7035+7016	



Armario con puertas correderas ranuradas de policarbonato 78x27 EH

ART.	A mm	P mm	H mm	 KG	RAL	
FAA2514C000PD	1428	600	2000	1200	7035+7016	



Armario con puertas correderas ranuradas de policarbonato 54+54x27 EH

ART.	A mm	P mm	H mm	 KG por sector	RAL	
FAA2520C000PD	2040	600	2000	1200	7035+7016	



Armarios con puertas correderas



Top de acero inox satinado

ART.	A mm	P mm	H mm	material	Acabado
FGG601006AX000A	1020	600	32	MDF	Inox satinado
FGG601406AX000A	1428	600	32	MDF	Inox satinado
FGG602006AX000A	2040	600	32	MDF	Inox satinado



Top de acero de goma

ART.	A mm	P mm	H mm	material	Acabado
FGG601006AG0007	1020	600	32	MDF	Acero engomado
FGG601406AG0007	1428	600	32	MDF	Acero engomado
FGG602006AG0007	2040	600	32	MDF	Acero engomado



Top de multiplex

ART.	A mm	P mm	H mm	material
FGG601006BE0000	1020	600	30	Multiplex
FGG601406BE0000	1428	600	30	Multiplex
FGG602006BE0000	2040	600	30	Multiplex

Estante ranurado P=500 mm

ART.	A mm	P mm	H mm	KG	Acabado
FAC9912010099	995	500	35	120	Galvanizado
FAC9814010099	1403	500	35	100	Galvanizado



Kit de estantes ranurados P=500 mm

ART.	A mm	P mm	H mm	n.º estantes	KG	Acabado
FAC9912020099	995	500	35	2	120	Galvanizado
FAC9912030099	995	500	35	3	120	Galvanizado
FAC9912040099	995	500	35	4	120	Galvanizado
FAC9814020099	1403	500	35	2	100	Galvanizado

Armarios con puertas correderas

Estante-panel perforado

Aplicable en 3 posiciones:

Panel perforado vertical

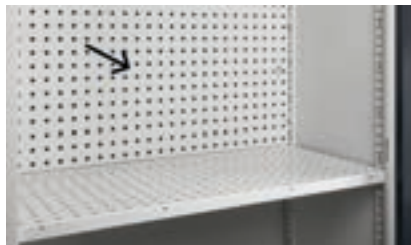

Estante horizontal



Repisa perforada con 4 bordes



Estante-panel perforado



ART.	A mm	P mm	H mm		Medida del orificio (mm)	Paso mm	RAL
FAC9912070039	995	500	30	120-50	10x10	38	7016
FAC9912070008	995	500	30	120-50	10x10	38	7035
FAC9912070004	995	500	30	120-50	10x10	38	5012

Kit de estantes-panes perforados

ART.	A mm	P mm	H mm	n.º estantes		Medida del orificio (mm)	Paso mm	RAL
FAC9912080008	995	500	30	2	120-50	10x10	38	7035
FAC9912080004	995	500	30	2	120-50	10x10	38	5012
FAC9912080039	995	500	30	2	120-50	10x10	38	7016



Cajones de extracción simple 54x27 EH



ART.	dim. útiles					H frontal cajón mm	RAL
	A mm	P mm	H mm				
FAC9912180008	908	449	85	50	88%	100	7035
FAC9912180004	908	449	85	50	88%	100	5012
FAC9912180039	908	449	85	50	88%	100	7016

Cajones de extracción telescópica 54x27 EH



ART.	dim. útiles					H frontal cajón mm	RAL
	A mm	P mm	H mm				
FAC9912190008	908	449	85	100	100%	100	7035
FAC9912190004	908	449	85	100	100%	100	5012
FAC9912190039	908	449	85	100	100%	100	7016
FAC9912210008	908	449	135	100	100%	150	7035
FAC9912210004	908	449	135	100	100%	150	5012
FAC9912210039	908	449	135	100	100%	150	7016

 GALVANIZADO
  RAL 5012
  RAL 7035
  RAL 7016
  CAPACIDAD
  EXTRACCIÓN

Armarios con puertas correderas

Cubas estancas internas colectoras de líquidos



ART.	A mm	P mm	H mm	KG	L	Acabado
FAC9911090099	484	500	42	50	9	Galvanizado
FAC9912090099	995	500	42	50	19	Galvanizado

Kit de cubas estancas internas colectoras de líquidos

ART.	A mm	P mm	H mm	KG	L	N. cubas	Acabado
FAC9911100099	484	500	42	50	9	2	Galvanizado
FAC9912100099	995	500	42	50	19	2	Galvanizado

Canaleta eléctrica para tomas múltiples



ART.	A mm	P mm	H mm	RAL
FAC9912220039	1008	64	140	7016



Esquema de tomas múltiples para canaleta eléctrica



- 1
- 2
- 3
- 3
- 4

- 1 magnetotérmico
- 2 toma múltiple de 4 compartimentos
- 3 toma múltiple de 2 compartimentos
- 4 USB recarga



Aplicación canaleta eléctrica en la **parte superior** del estante-panel perforado



Aplicación canaleta eléctrica en la **parte inferior** del estante-panel perforado



Canaleta eléctrica **integrable** con estante-panel perforado en posición vertical

Soporte lateral para toma múltiple



ART.	A mm	P mm	H mm	RAL
FAC9912240039	10	463	77	7016

Esquema de tomas múltiples para soporte lateral

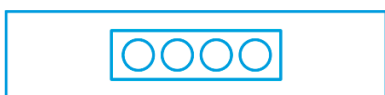

toma múltiple de 4 compartimentos



Ejemplo de aplicación con:
 1 soporte art. FAC9912240039
 1 toma múltiple art. FBLET005007
 1 cable de conexión art. FBLET016007

Armarios con puertas correderas



Rejilla para ventiladores

ART.	A mm	P mm	H mm	RAL
FAC9912230039	994	123	136	7016

Ejemplo de aplicación con:
 1 rejilla art. FAC9912230039
 2 ventiladores art. FAS32200100
 1 toma múltiple art. FBLET005007
 1 cable de conexión art. FBLET016007



Aplicación de la rejilla en la **parte superior** del armario **sin** la ayuda del **estante-panel perforado**



Aplicación de la rejilla en la **parte superior** del armario **con** la ayuda del **estante-panel perforado**



Aplicación de la rejilla en la **parte inferior** del armario **con** la ayuda del **estante-panel perforado**



Ventilador 230V sin rejilla con clavija Schuko

ART.	A mm	P mm	H mm	color
FAS32200100	125	44	125	Negro



ver página 96



FBLET012007



FBLET004007



FBLET005007



FBLET016007



FBLET014007



FBLET020007



FBL99400008

Aplicación de la lámpara bajo el estante-panel perforado



GALVANIZADO



RAL 7016



CAPACIDAD



CAPACIDAD

Armarios con puertas correderas

- 1. Tabique divisor
- 2. Kit tubo percha
- 3. Estante-panel perforado
- 4. Estante ranurado
- 5. Cajón de extracción simple H=100 mm

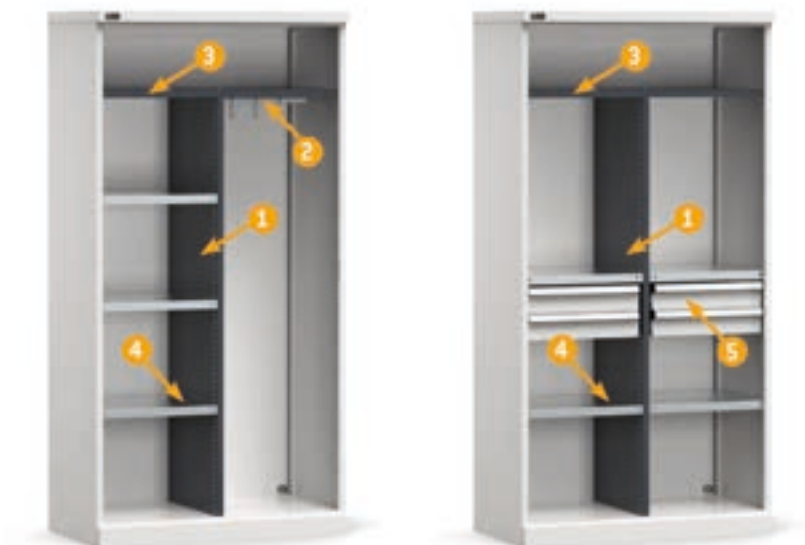

Tabique divisor

ART.	A mm	P mm	H mm	Paso mm	RAL
FAC9912260039	44	500	1616	25	7016

Kit tubo percha

ART.	A mm	P mm	H mm	KG	Acabado
FAC9912270099	458	23	56	15	Galvanizado

Estante-panel perforado

ART.	A mm	P mm	H mm	KG	RAL
FAC9912070039	995	500	30	120-50	7016

Estante ranurado P=500 mm

ART.	A mm	P mm	H mm	KG	Acabado
FAC9911010099	484	500	35	120	Galvanizado

Kit de estantes ranurados P=500 mm

ART.	A mm	P mm	H mm	n.º estantes	KG	Acabado
FAC9911020099	484	500	35	2	120	Galvanizado
FAC9911030099	484	500	35	3	120	Galvanizado

Cajones de extracción simple 24x27 EH

ART.	dim. útiles			KG	%	H frontal cajón mm	RAL
	A mm	P mm	H mm				
FAC9911180008	398	449	85	50	88%	100	7035
FAC9911180004	398	449	85	50	88%	100	5012
FAC9911180039	398	449	85	50	88%	100	7016

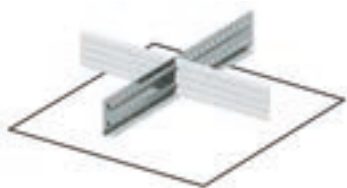
PERFOM**MATERIAL DE SEPARACIÓN****A= 512 MM****24X27 EH**

ART.	apto para cajón H mm	componentes	
FFH00500100	100	2 x Divisor transversal A=202 mm 1 x Separador longitudinal ranurado A=457 mm	

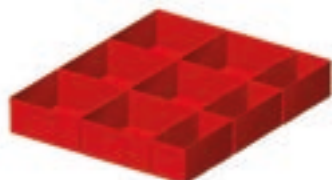

ART.	apto para cajón H mm	componentes	
FFH00500800	100/125	3 x Caja divisor 150x75 mm 6 x Caja divisor 150x150 mm	

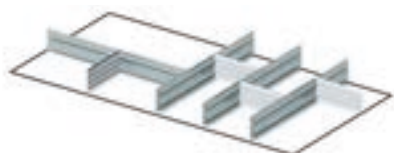

ART.	apto para cajón H mm	componentes	
FFH00500900	100/125	15 x Caja divisor 150x75 mm	

A= 1023 MM**54X27 EH**

ART.	apto para cajón H mm	componentes	
FFH02000100	100	4 x Separador longitudinal ranurado A=457 mm 4 x Divisor trasversal A=151 mm	

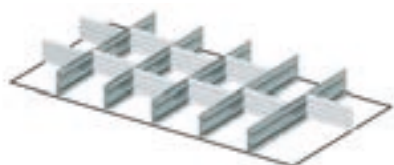

ART.	apto para cajón H mm	componentes	
FFH02000200	100	5 x Separador longitudinal ranura A=457 mm 10 x Divisor trasversal A=151 mm	



ART.	apto para cajón H mm	componentes	
FFH02000600	100/125	12 x Caja divisor 150x75 mm 12 x Caja divisor 150x150 mm	

PERFOM

ARMARIOS PARA VESTUARIO



**Pies de polipropileno -
fácil limpieza**

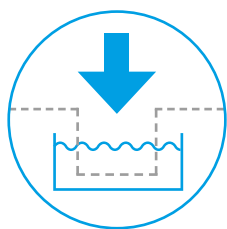

**Pintura en
electroforesis**

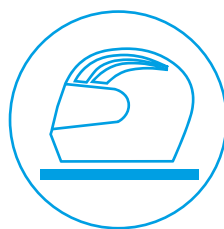

**Versión con
compartimento porta
casco**



Cierre con llave

PERFOM



ART.	A mm	P mm	H mm	N. compartimentos	RAL	
PERFOMAN01	1195	502	1950	4	7035	

Compuesto por:

cant.	descripción
1	Armario para vestuario de techo horizontal con 4 compartimentos
1	Par de pies para armario para vestuario



ART.	A mm	P mm	H mm	N. compartimentos	RAL	
PERFOMAN02	1195	502	1950	3	7035	

Compuesto por:

cant.	descripción
1	Armario para vestuario de techo horizontal con 3 compartimentos
1	Par de pies para armario para vestuario



ART.	A mm	P mm	H mm	N. compartimentos	RAL	
PERFOMAN03	1195	502	2170	4	7035	

Compuesto por:

cant.	descripción
1	Armario para vestuario de techo horizontal con 4 compartimentos
1	Techo inclinado adicional
1	Par de pies para armario para vestuario

PERFOM



ART.	A mm	P mm	H mm	N. compartimentos	RAL	
PERFOMAN04	1195	502	2170	3	7035	

Compuesto por:

cant.	descripción
1	Armario para vestuario de techo horizontal con 3 compartimentos
1	Techo inclinado adicional
1	Par de pies para armario para vestuario

Banco individual



ART.	A mm	P mm	H mm	KG	RAL	
FAN95400001	1000	360	385/400	200	7000	



ART.	A mm	P mm	H mm	KG	RAL	
FAN95500001	1494	360	385/400	200	7000	



ART.	A mm	P mm	H mm	KG	RAL	
FAN95600001	2000	360	385/400	300	7000	



ART.	A mm	P mm	H mm	N. compartimentos	RAL	
FAN1302C00108	608	502	1750	2	7035	



Techo inclinado adicional

ART.	A mm	P mm	H mm	RAL	
FAN51400008	607	502	220	7035	



ART.	A mm	P mm	H mm	N. compartimentos	RAL	
FAN1303C00108	900	502	1750	3	7035	



Techo inclinado adicional

ART.	A mm	P mm	H mm	RAL	
FAN51600008	899	502	220	7035	



RAL 7000



RAL 7035



CAPACIDAD



ART.	A mm	P mm	H mm	N. compartimentos	RAL	
FAN1304C00108	1192	502	1750	4	7035	



Techo inclinado adicional

ART.	A mm	P mm	H mm	RAL	
FAN51800008	1191	502	220	7035	



Par de pies para armario para vestuario

ART.	A mm	P mm	H mm	color	
FRR23100001	135	500	180/200	Gris oscuro	



ART.	A mm	P mm	H mm	N. compartimentos	RAL	
FAN1502C03108	802	502	1750	2	7035	



Techo inclinado adicional

ART.	A mm	P mm	H mm	RAL	
FAN51500008	801	502	220	7035	



ART.	A mm	P mm	H mm	N. compartimentos	RAL	
FAN1503C03108	1192	502	1750	3	7035	



Techo inclinado adicional

ART.	A mm	P mm	H mm	RAL	
FAN51800008	1191	502	220	7035	

NC

PORTA HERRAMIENTAS



Cajones de extracción total



Armario capacidad 1200 kg

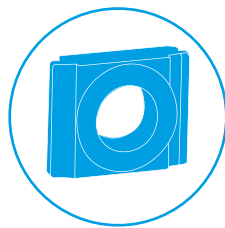

Amplia gama de casquillos

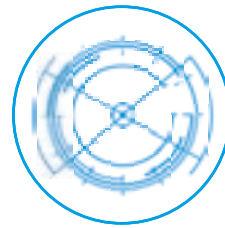

Configurable



ART.	A mm	P mm	H mm	KG	N. par de bastidores por armario	N. par de bastidores por cajón	N. cajones	N. casquillos	tipo casquillo	RAL
PERFOMNC01	1023	555	2000	1200	2	-	-	84	ISO 40	7035
PERFOMNC02	1023	555	2000	1200	2	-	-	84	ISO 40	5012
PERFOMNC03	1023	555	2000	1200	2	-	-	50	ISO 50	7035
PERFOMNC04	1023	555	2000	1200	2	-	-	50	ISO 50	5012
PERFOMNC05	1023	555	2000	1200	2	-	-	60	HSK A63-B80	7035
PERFOMNC06	1023	555	2000	1200	2	-	-	60	HSK A63-B80	5012
PERFOMNC07	1023	555	2000	1200	1	1	2	84	ISO 40	7035
PERFOMNC08	1023	555	2000	1200	1	1	2	84	ISO 40	5012
PERFOMNC09	1023	555	2000	1200	1	1	2	50	ISO 50	7035
PERFOMNC10	1023	555	2000	1200	1	1	2	50	ISO 50	5012
PERFOMNC11	1023	555	2000	1200	1	1	2	60	HSK A63-B80	7035
PERFOMNC12	1023	555	2000	1200	1	1	2	60	HSK A63-B80	5012



ART.	A mm	P mm	H mm	KG sin ruedas	KG set de ruedas	N. bastidores	N. casquillos	tipo casquillo	RAL
COMBINC01	1064	512	892	500	825	3	35	ISO 40	7035+7000
COMBINC02	1064	512	892	500	825	3	35	ISO 40	5012+7000
COMBINC03	1064	512	892	500	825	3	25	ISO 50	7035+7000
COMBINC04	1064	512	892	500	825	3	25	ISO 50	5012+7000
COMBINC05	1064	512	892	500	825	3	25	HSK A63-B80	7035+7000
COMBINC06	1064	512	892	500	825	3	25	HSK A63-B80	5012+7000



RAL 7035



RAL 5012



RAL 5012+RAL 7000



RAL 7035+RAL 7000







CAPACIDAD



Bastidor porta casquillos para banco

ART.	A mm	P mm	H mm	RAL
FNC20100008	565	450	351	7035
FNC20100004	565	450	351	5012

Casquillo

ART.	tipo	Unidad de venta	cant. máx.					
								
FNC95100003	ISO 30	7	7	21	42	35	21	
FNC95300003	ISO 40	7	7	21	42	35	21	
FNC95400003	ISO 45	6	6	18	30	30	18	
FNC95500003	ISO 50	5	5	15	25	20	15	
FNC95600003	VDI 30	7	7	21	42	35	21	
FNC95700003	VDI 40	5	5	15	30	30	15	
FNC95800003	VDI 50	5	5	15	30	30	15	
FNC95900003	VDI 60	5	5	15	25	20	15	
FNC97200003	CONO MORSE 2	7	7	21	42	35	21	
FNC97300003	CONO MORSE 3	7	7	21	42	35	21	
FNC97400003	CONO MORSE 4	7	7	21	42	35	21	
FNC97500003	CONO MORSE 5	5	5	15	30	30	15	
FNC92700003	CAPTO C3	7	7	21	42	35	21	
FNC92750003	CAPTO C4	5	5	15	30	30	15	
FNC92800003	CAPTO C5	5	5	15	30	30	15	
FNC92850003	CAPTO C6	5	5	15	30	30	15	
FNC92900003	CAPTO C8	5	5	15	20	20	15	
FNC92100003	HSK A32-B40	7	7	21	42	35	21	
FNC92200003	HSK A40-B50	7	7	21	42	35	21	
FNC92300003	HSK A50-B63	5	5	15	30	30	15	
FNC92400003	HSK A63-B80	5	5	15	30	30	15	
FNC92500003	HSK A80-B100	5	5	15	20	20	15	
FNC92600003	HSK A100-B125	5	5	15	20	20	15	
FNC96400003	2"	6	6	18	30	30	18	
FNC96500003	2" 1/4	5	5	15	25	20	15	



Armario de puertas batientes 54x27 EH

ART.	A mm	P mm	H mm	KG	RAL
FAA1420C000PD	1023	555	2000	1200	7035+7016
FAA1420C00008	1023	555	2000	1200	7035
FAA1420C00004	1023	555	2000	1200	5012

Cajones de extracción telescópica 54x27 EH

ART.	dim. útiles			KG	%	H frontal cajón mm	RAL
	A mm	P mm	H mm				
FAC9912190008	908	449	85	100	100%	100	7035
FAC9912190004	908	449	85	100	100%	100	5012
FAC9912190039	908	449	85	100	100%	100	7016
FAC9912210008	908	449	135	100	100%	150	7035
FAC9912210004	908	449	135	100	100%	150	5012
FAC9912210039	908	449	135	100	100%	150	7016



Bastidor porta casquillos de 3 filas para cajones con soportes - paquete 2 ud.

Casquillos excluidos

ART.	A mm	P mm	H mm	RAL
FNC5140S101	894	446	142/180	7000

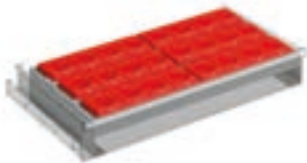

Bastidor porta casquillos de 3 filas para armario - paquete de 2 unidades

ART.	A mm	P mm	H mm	KG	RAL
FNC5160S101	965	444	68	150	7000



RUEDA GIRATORIA



RUEDA GIRATORIA CON FRENO



RUEDA FIJA

Carro porta herramientas con ruedas

ART.	A mm	P mm	H mm	Sin ruedas	Ruedas						RAL
					Ø mm	material	KG set de ruedas	1	1	2	
FCNF1001056	1064	512	892	500	125	Nailon	825	1	1	2	7035+7000
FCNF1001051	1064	512	892	500	125	Nailon	825	1	1	2	5012+7000



RAL 7000



RAL 7035



RAL 5012



RAL 7016



RAL 5012 + RAL 7000



RAL 7035 + RAL 7000



RAL 7035 + RAL 7016



CAPACIDAD



EXTRACCIÓN

ECOLOGÍA

Las cubas colectoras evitan los derrames accidentales de sustancias peligrosas y contaminantes, en cumplimiento del D.Lgs. N.152/2006 y D.Lgs. N.81/2008. ¡Atención! Recordar no almacenar en la misma cuba sustancias químicas que puedan reaccionar entre sí y comprobar la compatibilidad de las sustancias peligrosas almacenadas con el material de fabricación de la cuba y la rejilla. La capacidad de los contenedores que pueden almacenarse encima de cada cuba y la información facilitada, que no es exhaustiva ni vinculante, son válidas para el territorio italiano. Para otros países, seguir la normativa específica vigente en el país de uso y ponerse en contacto con las autoridades locales competentes para obtener más información.



CUBAS COLECTORAS + REPISAS Y BANDEJAS PERFORM DE ACERO

Adecuadas para líquidos inflamables de las categorías GHS 1 – 3 y líquidos contaminantes del agua de las categorías GHS 1 – 4. Sustancias corrosivas no permitidas.

CUBAS COLECTORAS DE PE

Adecuadas para líquidos contaminantes del agua de las categorías GHS 1 – 4. Sustancias inflamables no permitidas.

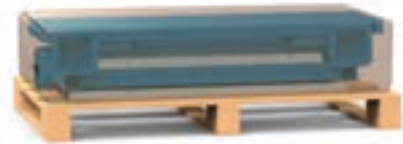

CE



El bastidor se suministra desmontado en un palet

Porta big bag regulable en altura

ART.	A mm	P mm	H mm	KG	RAL	
FAXEBB1002H0004	1090	1084	1205/1395	1000	5012	



- Patas regulables en altura (1205 - 1395 mm) para acomodar big bags de dos tamaños diferentes
- Estantes inferiores lisos para un mayor soporte de las bolsas
- Capacidad testada: 1000 kg
- Superposición: 1+2 bastidores
- Posibilidad de introducir y extraer el big bag incluso en caso de bastidores superpuestos
- Embalaje de cartón en un palet sin fumigar

 RAL 5012

 CAPACIDAD

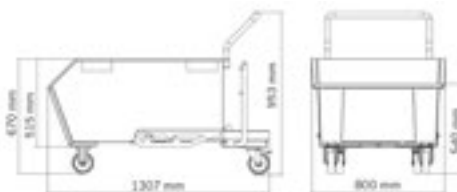

Cuchara portarresiduos basculante capacidad 300 l con ruedas preparada para rejilla y grifo

ART.	A mm	P mm	H mm	L	KG	Ruedas						RAL
						Ø mm	h mm	material	KG set de ruedas	↺	↻	
FAXEPR030060004	1307	800	953	300	600	125	155	Nailon	825	2	2	5012

⚠ Cuchara suministrada desmontada

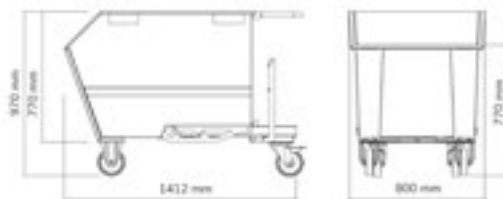

Cuchara portarresiduos basculante capacidad 500 l con ruedas preparada para rejilla y grifo

ART.	A mm	P mm	H mm	L	KG	Ruedas						RAL
						Ø mm	h mm	material	KG set de ruedas	↺	↻	
FAXEPR050060004	1412	800	970	500	1000	160	200	Nailon	1050	2	2	5012

⚠ Cuchara suministrada desmontada

Grifo frontal para la descarga de los líquidos residuales

Kit de grifo + rejilla

ART.	A mm	P mm	H mm	apto para
FAXEAC001000099	700	388	25	FAXEPR0300600
FAXEAC003000099	685	388	25	FAXEPR0500600
FAXEAC002000099	1028	388	25	FAXEPR0750600



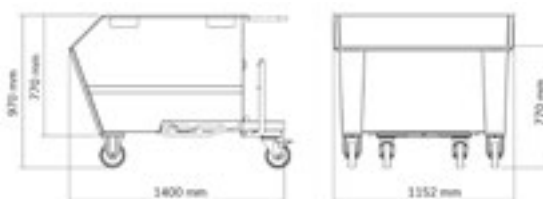

Cuchara portarresiduos basculante capacidad 750 l con ruedas preparada para rejilla y grifo

ART.	A mm	P mm	H mm	L	KG	Ruedas						RAL
						Ø mm	h mm	material	KG set de ruedas	🔄	🛑	
FAXEPR075060004	1400	1152	970	750	1350	160	200	Nailon	1050	2	2	5012

⚠️ Cuchara suministrada desmontada

Cilindro hidráulico para el vuelco frenado de la cuchara

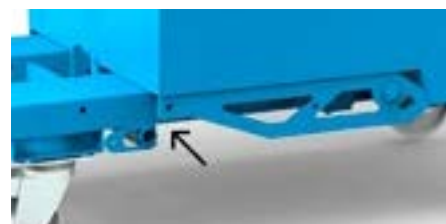

Cilindro hidráulico para cuchara

ART.	A mm	P mm	H mm
FAXEAC004000007	401/671	42	42



RUEDA GIRATORIA CON FRENO



RUEDA FIJA



RAL 5012



CAPACIDAD



CAPACIDAD

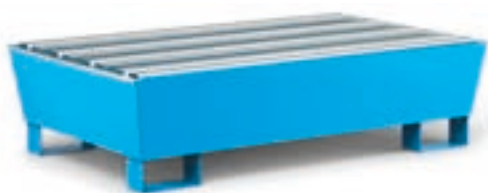

Cuba cónica de recogida capacidad 200 l

ART.	A mm	P mm	H mm	RAL	
ECO1302	1310	800	351	5012	

Compuesto por:

cant.	descripción
1	Cuba cónica de recogida capacidad 200 l
2	Kit 2 duelas
1	Kit 2 peines para cuba cónica



ver página 256



Cuba de recogida capacidad 200 l

ART.	A mm	P mm	H mm	RAL	
ECO1303	1300	805	400	5012	

Compuesto por:

cant.	descripción
1	Cuba de recogida capacidad 200 l
2	Kit 2 duelas
1	Kit 2 peines A=800 mm



ver página 256



Cuba de recogida capacidad 300 l

ART.	A mm	P mm	H mm	RAL	
ECO1304	1300	1205	400	5012	

Compuesto por:

cant.	descripción
1	Cuba de recogida capacidad 300 l
3	Kit 2 duelas
1	Kit 2 peines A=1200 mm



ver página 256



Cuba de recogida capacidad 400 l

ART.	A mm	P mm	H mm	RAL
ECO1306	1300	1222	400	5012

Compuesto por:

cant.	descripción
1	Cuba de recogida capacidad 300 l
3	Kit 2 duelas
1	Kit 2 peines A=1200 mm
1	Kit 2 tapones con junta

El uso del kit de tapones aumenta la capacidad de la cuba de 300 litros a 400 litros



ver página 256

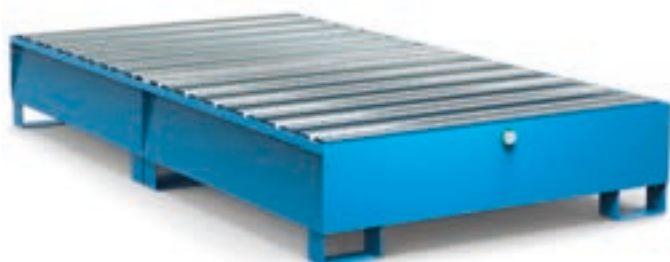

Cuba de recogida capacidad 800 l

ART.	A mm	P mm	H mm	RAL
ECO1307	1300	2422	400	5012

Compuesto por:

cant.	descripción
2	Cuba de recogida capacidad 300 l
6	Kit 2 duelas
2	Kit 2 peines A=1200 mm
1	Kit de acoplamiento de cubas
1	Kit 2 tapones con junta



ver página 256



Ejemplo de acoplamiento de cubas:

1. Kit de acoplamiento de cubas (compuesto de perfil de acero galvanizado salvagotas y colector con dos juntas)
2. Kit 2 tapones con junta



Cuba de recogida capacidad 300 l con portabidones

ART.	A mm	P mm	H mm	RAL	
ECO1311	1300	1205	787	5012	

Compuesto por:

cant.	descripción
1	Cuba de recogida capacidad 300 l
2	Kit 2 duelas
1	Portabidones para 2 bidones



ver página 256

Bidones excluidos



Cuba de recogida capacidad 200 l con ruedas

ART.	A mm	P mm	H mm	RAL	
ECO1308	1491	800	1018	5012+7016	

Compuesto por:

cant.	descripción
1	Cuba de recogida capacidad 200 l
2	Kit 2 duelas
1	Kit 2 peines A=800 mm
1	Asa para cuba
1	Kit de ruedas de nailon Ø 125 mm



ver página 256

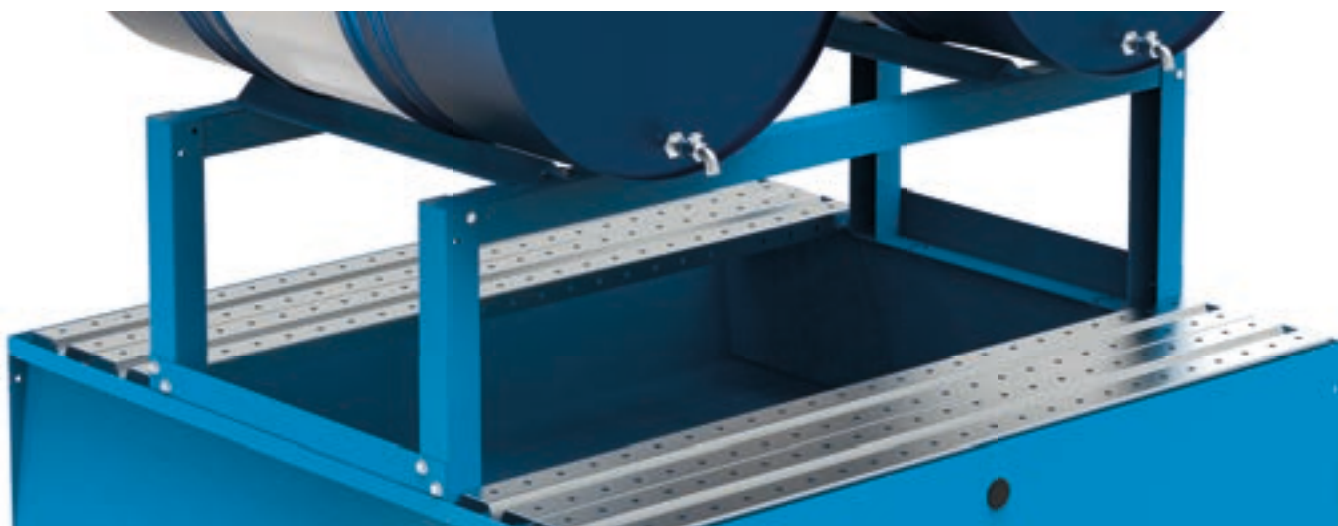



Cuba de recogida capacidad 1000 l

ART.	A mm	P mm	H mm	RAL	
ECO1305	1600	1300	640	5012	

Compuesto por:

cant.	descripción
1	Cuba de recogida capacidad 1000 l
4	Kit 2 duelas
2	Kit 2 peines A=800 mm



ver página 256



Cuba de recogida capacidad 1000 l con bastidor

ART.	A mm	P mm	H mm	RAL	
ECO1309	1600	1306	1065	5012	

Compuesto por:

cant.	descripción
1	Cuba de recogida capacidad 1000 l
4	Kit 2 duelas
1	Bastidor con cuba de recogida



ver página 256

Cisterna excluida





ver página 256

Cisternas excluidas

Cuba de recogida capacidad 1100 l con bastidores

ART.	A mm	P mm	H mm	RAL	
ECO1313	1306	3222	825	5012	

Compuesto por:

cant.	descripción
2	Cuba de recogida capacidad 300 l
1	Cuba de recogida capacidad 200 l
8	Kit 2 duelas
2	Bastidor con cuba de recogida
1	Kit 2 tapones con junta
2	Kit de acoplamiento de cubas

El uso del kit de tapones aumenta la capacidad de la cuba de 300 litros a 400 litros mientras que el volumen de contención de la cuba de 200 litros aumenta a 300 litros.



Ejemplo de acoplamiento de cubas:

1. Cuba de recogida capacidad 300 l
2. Cuba de recogida capacidad 200 l
3. Kit 2 tapones con junta
4. Kit de acoplamiento de cubas (compuesto de perfil de acero galvanizado salvagotas y colector con dos juntas)



ver página 256

Cisternas y bidones excluidos

Cuba de recogida capacidad 1100 l con bastidores y portabidones

ART.	A mm	P mm	H mm	RAL
ECO1312	1306	3222	825	5012

Compuesto por:

cant.	descripción
2	Cuba de recogida capacidad 300 l
1	Cuba de recogida capacidad 200 l
7	Kit 2 duelas
1	Portabidones para 2 bidones
1	Bastidor con cuba de recogida
2	Kit de acoplamiento de cubas
1	Kit 2 tapones con junta

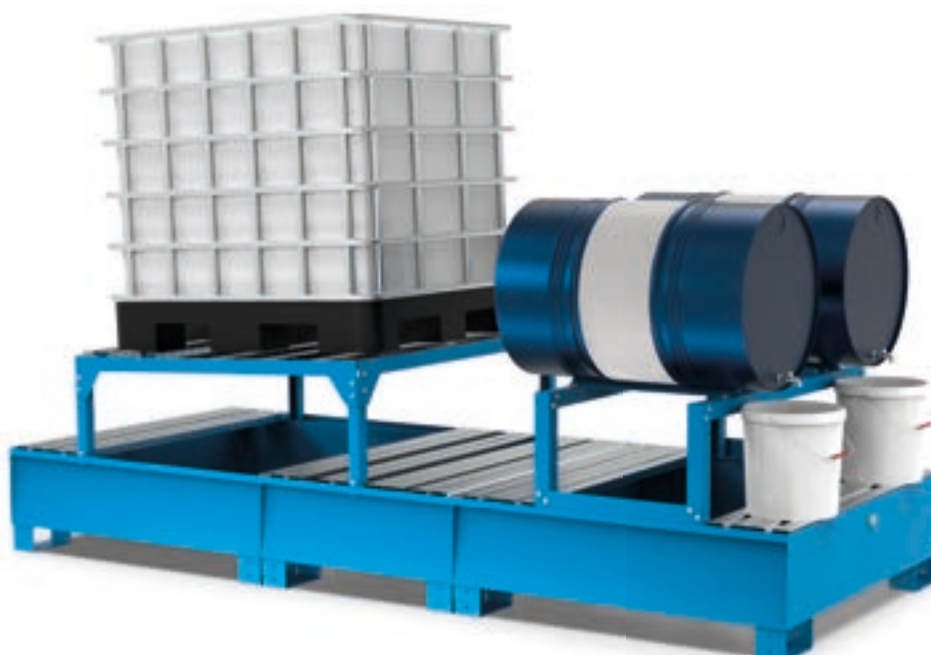



Soporte de polietileno para elevación

ART.	A mm	P mm	H mm	para bidones		color	
				n.º	L		
FAX002068000005	465	610	410	1	200	Amarillo	
FAX002070000005	1200	780	255	2	200	Amarillo	



Cuba colectora de polietileno con rejilla para bidones

ART.	A mm	P mm	H mm	L	para bidones		color	
					n.º	L		
FAX002064000005	925	800	420	225	1	200	Amarillo	
FAX002065000005	1350	800	420	305	2	200	Amarillo	
FAX002066000005	1350	1350	490	500	4	200	Amarillo	



ver página 256



Cuba colectora de polietileno con rejilla para cisterna

ART.	A mm	P mm	H mm	L	para cisterna		color	
					n.º	L		
FAX002067000005	1350	1350	970	1050	1	1000	Amarillo	



ver página 256



ART.	A mm	P mm	H mm	KG	RAL	
PERFOM12013	1048	600	1027	800	1004	
PERFOM12014	1048	600	1027	800	7035+7016	
PERFOM12015	1048	600	1027	800	7035	
PERFOM12016	1048	600	1027	800	5012	

Compuesto por:

cant.	descripción
1	Armario de puertas batientes ranuradas
1	Estante ranurado
1	Cuba estanca externa colectora de líquidos capacidad 59 L



ver página 256



ART.	A mm	P mm	H mm	KG	RAL	
PERFOM12017	1023	555	1000	800	1004	
PERFOM12018	1023	555	1000	800	7035+7016	
PERFOM12019	1023	555	1000	800	7035	
PERFOM12020	1023	555	1000	800	5012	

Compuesto por:

cant.	descripción
1	Armario de puertas batientes ranuradas
1	Kit de 2 cubas estancas internas colectoras de líquidos capacidad 19 L



ver página 256



ART.	A mm	P mm	H mm	KG	RAL	
PERFOM12025	1048	600	1027	800	6011	

Compuesto por:

cant.	descripción
1	Armario de puertas batientes ranuradas
1	Estante ranurado
1	Cuba estanca externa colectora de líquidos capacidad 59 L



ver página 256



RAL 6011



RAL 1004



RAL 5012



RAL 7035



RAL 7035 + RAL 7016



CAPACIDAD



CAPACIDAD



ART.	A mm	P mm	H mm	KG	RAL	
PERFORM14056	1048	600	2027	1200	6011	

Compuesto por:

cant.	descripción
1	Armario de puertas batientes ranuradas
1	Kit de 3 estantes ranurados
1	Cuba estanca externa colectora de líquidos capacidad 59 L



ver página 256



ART.	A mm	P mm	H mm	KG	RAL	
PERFORM14057	1023	555	2000	1200	6011	

Compuesto por:

cant.	descripción
1	Armario de puertas batientes ranuradas
2	Kit de 2 cubas estancas internas colectoras de líquidos capacidad 19 L



ver página 256



ART.	A mm	P mm	H mm	KG	RAL	
PERFORM14058	1023	555	2000	1200	7035	

Compuesto por:

cant.	descripción
1	Armario de puertas batientes ranuradas de policarbonato
2	Kit de 2 cubas estancas internas colectoras de líquidos capacidad 19 L



ver página 256



ART.	A mm	P mm	H mm	KG	RAL	
PERFOM14025	1048	600	2027	1200	1004	
PERFOM14026	1048	600	2027	1200	7035+7016	
PERFOM14027	1048	600	2027	1200	7035	
PERFOM14028	1048	600	2027	1200	5012	

Compuesto por:

cant.	descripción
1	Armario de puertas batientes ranuradas
1	Kit de 3 estantes ranurados
1	Cuba estanca externa colectora de líquidos capacidad 59 L



ver página 256



ART.	A mm	P mm	H mm	KG	RAL	
PERFOM14029	1023	555	2000	1200	1004	
PERFOM14030	1023	555	2000	1200	7035+7016	
PERFOM14031	1023	555	2000	1200	7035	
PERFOM14032	1023	555	2000	1200	5012	

Compuesto por:

cant.	descripción
1	Armario de puertas batientes ranuradas
2	Kit de 2 cubas estancas internas colectoras de líquidos capacidad 19 L



ver página 256



RAL 6011



RAL 1004



RAL 5012



RAL 7035



RAL 7035 + RAL 7016



CAPACIDAD

CLEVER-COMBI

CARROS



Fácil de montar



Capacidad estantes 100 kg

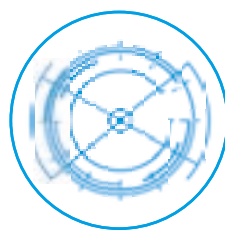

Configurable

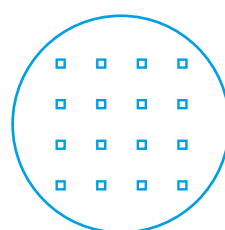

Orificios cuadrados de 10x10

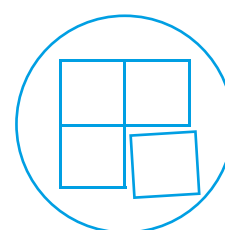

Componible

CLEVER SMALL



ART.	A mm	P mm	H mm	 Sin ruedas	 set de ruedas	RAL	
CLEVER0903	908	515	819	300	225	7035	
CLEVER0904	908	515	819	300	225	5012	

Compuesto por:

cant.	descripción
1	Carro desmontado sin ruedas
1	Kit de ruedas de goma standard Ø 100 mm



ART.	A mm	P mm	H mm	 Sin ruedas	 set de ruedas	RAL	
CLEVER0905	908	515	819	300	225	7035	
CLEVER0906	908	515	819	300	225	5012	

Compuesto por:

cant.	descripción
1	Carro desmontado sin ruedas
1	Estante adicional
1	Kit de ruedas de goma standard Ø 100 mm



ART.	A mm	P mm	H mm	 Sin ruedas	 set de ruedas	RAL	
CLEVER0907	908	515	846	300	300	7035	
CLEVER0908	908	515	846	300	300	5012	

Compuesto por:

cant.	descripción
1	Carro desmontado sin ruedas
1	Estante adicional
1	Kit de ruedas de goma antihuella sintética Ø 125 mm

CLEVER LARGE



ART.	A mm	P mm	H mm	 Sin ruedas	 set de ruedas	RAL	
CLEVER1003	1028	615	819	300	225	7035	
CLEVER1004	1028	615	819	300	225	5012	

Compuesto por:

cant.	descripción
1	Carro desmontado sin ruedas
1	Kit de ruedas de goma standard Ø 100 mm



ART.	A mm	P mm	H mm	 Sin ruedas	 set de ruedas	RAL	
CLEVER1005	1028	615	846	300	300	7035	
CLEVER1006	1028	615	846	300	300	5012	

Compuesto por:

cant.	descripción
1	Carro desmontado sin ruedas
1	Estante adicional
1	Kit de ruedas de goma standard Ø 125 mm



ART.	A mm	P mm	H mm	 Sin ruedas	 set de ruedas	RAL	
CLEVER1007	1028	615	846	300	300	7035	
CLEVER1008	1028	615	846	300	300	5012	

Compuesto por:

cant.	descripción
1	Carro desmontado sin ruedas
1	Estante adicional
1	Kit de ruedas de goma antihuella sintética Ø 125 mm

CLEVER LARGE



ART.	A mm	P mm	H mm	 Sin ruedas	 set de ruedas	RAL	
CLEVER1009	1028	615	868	300	300	7035	
CLEVER1010	1028	615	868	300	300	5012	

Compuesto por:

cant.	descripción
1	Carro desmontado sin ruedas
1	Estante de madera con soportes
1	Kit de ruedas de goma antihuella sintética Ø 125 mm



ART.	A mm	P mm	H mm	 Sin ruedas	 set de ruedas	RAL	
CLEVER1011	1030	615	846	300	300	7035	
CLEVER1012	1030	615	846	300	300	5012	

Compuesto por:

cant.	descripción
1	Carro desmontado sin ruedas
1	Estante adicional
2	Panel lateral perforado
1	Kit de ruedas de goma antihuella sintética Ø 125 mm



ART.	A mm	P mm	H mm	 Sin ruedas	 set de ruedas	RAL	
CLEVER1013	1030	615	868	300	300	7035	
CLEVER1014	1030	615	868	300	300	5012	

Compuesto por:

cant.	descripción
1	Carro desmontado sin ruedas
1	Estante de madera con soportes
2	Panel lateral perforado
1	Kit de ruedas de goma antihuella sintética Ø 125 mm

RAL 7035

RAL 5012

 CAPACIDAD

CLEVER LARGE



ART.	A mm	P mm	H mm	 Sin ruedas	 set de ruedas	RAL	
CLEVER1015	1030	630	868	300	300	7035	
CLEVER1016	1030	630	868	300	300	5012	

Compuesto por:

cant.	descripción
1	Carro desmontado sin ruedas
1	Estante de madera con soportes
2	Panel lateral perforado
1	Panel trasero perforado
1	Kit de ruedas de goma antihuella sintética Ø 125 mm





ART.	A mm	P mm	H mm	 Sin ruedas	 set de ruedas	RAL	
CLEVER1017	1030	655	868	300	300	7035	
CLEVER1018	1030	655	868	300	300	5012	

Compuesto por:

cant.	descripción
1	Carro desmontado sin ruedas
1	Estante de madera con soportes
2	Panel lateral perforado
1	Panel trasero perforado
1	Par de puertas batientes
1	Kit de ruedas de goma antihuella sintética Ø 125 mm



ART.	A mm	P mm	H mm	 Sin ruedas	 set de ruedas	RAL	
CLEVER1019	1028	615	846	300	300	7035+7016	
CLEVER1020	1028	615	846	300	300	5012	

Compuesto por:

cant.	descripción
1	Carro desmontado sin ruedas
1	Estante adicional
1	Armario A=500 mm con 1 cajón H=150 mm
1	Kit de ruedas de goma antihuella sintética Ø 125 mm

CLEVER LARGE



ART.	A mm	P mm	H mm	 Sin ruedas	 set de ruedas	RAL	
CLEVER1021	1030	633	1538	300	300	7035	
CLEVER1022	1030	633	1538	300	300	5012	

Compuesto por:

cant.	descripción
1	Carro desmontado sin ruedas
1	Estante de madera con soportes
2	Panel lateral perforado
1	Panel trasero perforado
1	Par de montantes para fijación del panel
1	Kit de ruedas de goma antihuella sintética Ø 125 mm





ART.	A mm	P mm	H mm	 Sin ruedas	 set de ruedas	RAL	
CLEVER1023	1030	658	1538	300	300	7035	
CLEVER1024	1030	658	1538	300	300	5012	

Compuesto por:

cant.	descripción
1	Carro desmontado sin ruedas
1	Estante de madera con soportes
2	Panel lateral perforado
2	Panel trasero perforado
1	Par de montantes para fijación del panel
1	Par de puertas batientes
1	Kit de ruedas de goma antihuella sintética Ø 125 mm



ART.	A mm	P mm	H mm	 Sin ruedas	 set de ruedas	RAL	
CLEVER1025	1028	654	1538	300	300	7035+7016	
CLEVER1026	1028	654	1538	300	300	5012	

Compuesto por:

cant.	descripción
1	Carro desmontado sin ruedas
1	Estante de madera con soportes
1	Panel trasero perforado
1	Par de montantes para fijación del panel
1	Armario A=500 mm con 1 cajón H=150 mm
1	Kit de ruedas de goma antihuella sintética Ø 125 mm



RAL 7035 + RAL 7016



RAL 7035





RAL 5012



CAPACIDAD

CLEVER LARGE



ART.	A mm	P mm	H mm	 Sin ruedas	 set de ruedas	RAL	
CLEVER1027	1347	633	1538	300	300	7035	
CLEVER1028	1347	633	1538	300	300	5012	

Compuesto por:

cant.	descripción
1	Carro desmontado sin ruedas
1	Estante de madera con soportes
2	Panel lateral perforado
1	Panel trasero perforado
1	Par de montantes para fijación del panel
1	Repisa grande reversible
1	Barra gancho con 3 contenedores Picking Box tamaño 2
1	Porta bombonas de 6 puestos
2	Porta silicona inclinado de 2 puestos
1	Kit porta rollo con papel Ø=240 mm
2	Imán con clip y tornillo - paquete de 10 unidades
1	Kit de ruedas de goma antihuella sintética Ø 125 mm



Carro desmontado sin ruedas

ART.	A mm	P mm	H mm	KG	RAL	
FCR10S0X208	908	515	691	300	7035	
FCR10S0X204	908	515	691	300	5012	
FCR11S0X208	1028	615	691	300	7035	
FCR11S0X204	1028	615	691	300	5012	



Kit de ruedas

ART.	Ø mm	KG	KG	H mm	material			
FKRD1002107	100	75	225	128	Goma standard	2	2	
FKRB1252107	125	100	300	155	Goma standard	2	2	
FKRU1252101	125	100	300	155	Goma antihuella sintética	2	2	
FKRS1252101	125	250	750	155	Goma elástica	2	2	



Estante adicional

ART.	A mm	P mm	H mm	apto para	KG	RAL	
FCR10120108	810	510	35	Carro Clever Small	100	7035	
FCR10120104	810	510	35		100	5012	
FCR11120108	930	610	35	Carro Clever Large	100	7035	
FCR11120104	930	610	35		100	5012	



RUEDA GIRATORIA CONFRENO



RUEDA FIJA



CAPACIDAD



RAL 7035



RAL 5012



Panel trasero perforado

ART.	A mm	P mm	H mm	apto para	Medida del orificio (mm)	Paso mm	RAL	
FCR11150108	895	22	690	Carro Clever Large	10x10	38	7035	
FCR11150104	895	22	690		10x10	38	5012	

! Para la instalación en la parte superior del carro es necesario pedir el par de montantes



Par de montantes para fijación del panel

ART.	A mm	P mm	H mm	RAL	
FCR10170139	45	35	650	7016	

! Para la instalación en la parte superior del carro es necesario pedir el par de montantes



Par de puertas batientes

ART.	A mm	P mm	H mm	apto para	Medida del orificio (mm)	Paso mm	RAL	
FCR11160108	936	44	690	Carro Clever Large	10x10	38	7035	
FCR11160104	936	44	690		10x10	38	5012	



Panel lateral perforado

ART.	A mm	P mm	H mm	apto para	Medida del orificio (mm)	Paso mm	RAL	
FCR11140108	573	7	688	Carro Clever Large	10x10	38	7035	
FCR11140104	573	7	688		10x10	38	5012	



Estante de madera con soportes

ART.	A mm	P mm	H mm	apto para	KG	
FCR11130100	930	610	51	Carro Clever Large	100	



Armario A=500 mm con 1 cajón H=150 mm

ART.	A mm	P mm	H mm	KG	RAL	
FBG03S50C0001PD	500	630	210	80	7035+7016	
FBG03S50C000104	500	630	210	80	5012	

IRONTEAM

ver página 90



FBL95410000

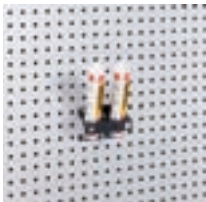

FBLIT008039



FBLIT004039



FBLIT010039



FBLIT013000



FBLIT017039



FBLET012007



FBLET004007



FBLET005007



FBLET016007



RAL 7016



RAL 7035 + RAL 7016



RAL 7035



RAL 5012



CAPACIDAD

CLEVER LARGE



ART.	A mm	P mm	H mm	KG		RAL	
				Sin ruedas	set de ruedas		
CLEVER1029	1347	658	1538	300	300	7035	
CLEVER1030	1347	658	1538	300	300	5012	

Compuesto por:

cant.	descripción
1	Carro desmontado sin ruedas
1	Estante de madera con soportes
2	Panel lateral perforado
2	Panel trasero perforado
1	Par de montantes para fijación del panel
1	Par de puertas batientes
1	Kit porta rollo con papel Ø=240 mm
1	Porta bombonas de 6 puestos
2	Repisa grande reversible
1	Canasta de 30 l de capacidad
1	Cable de conexión Wieland Schuko/FR
1	Toma múltiple Schuko de 4 compartimentos
1	Toma múltiple Schuko de 2 compartimentos
1	Soporte toma múltiple de 4 compartimentos
1	Soporte toma múltiple de 2 compartimentos
2	Imán con clip y tornillo - paquete de 10 unidades
1	Kit de ruedas de goma antihuella sintética Ø 125 mm



Carro con base de acero con ruedas

ART.	A mm	P mm	H mm	Sin ruedas 	Ruedas						RAL
					Ø mm	material	set de ruedas 				
FCEP1052004	1095	700	1000	500	200	Goma standard	615	1	1	2	5012





Carro con base de acero con ruedas

ART.	A mm	P mm	H mm	Sin ruedas 	Ruedas						RAL
					Ø mm	material	set de ruedas 				
FCEB1050308	1135	700	915	500	125	Goma standard	300	1	1	2	7035
FCEB1050304	1135	700	915	500	125	Goma standard	300	1	1	2	5012



Carro con base de acero con ruedas

ART.	A mm	P mm	H mm		Ruedas		RAL
					Ø mm		
FCR00210008	555	445	845	150	100	4	7035
FCR00210004	555	445	845	150	100	4	5012



RUEDA GIRATORIA CON FRENO



RUEDA GIRATORIA



RUEDA FIJA



RAL 7035



RAL 5012



CAPACIDAD

BIN CART

CARROS COMPONIBLES MULTIUSO



Fácil de montar



**Capacidad de carga
del carro 300 kg**

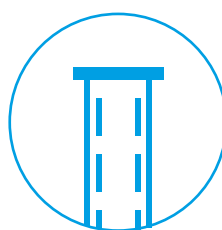

**Montante perforado
paso 38 mm**

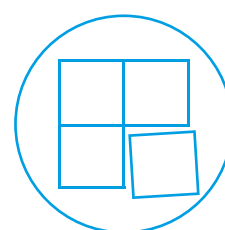

Componible

BIN CART



ART.	A mm	P mm	H mm	 Sin ruedas	 set de ruedas	RAL	
BINCART1001	1067	668	1357	300	300	7016	

Compuesto por:

cant.	descripción
1	Carro desmontado sin ruedas
2	Set de 5 perfiles con 90 contenedores Picking Box tamaño 1
1	Kit de ruedas de goma antihuella sintética Ø 125 mm



ART.	A mm	P mm	H mm	 Sin ruedas	 set de ruedas	RAL	
BINCART1002	1067	668	1357	300	300	7016	

Compuesto por:

cant.	descripción
1	Carro desmontado sin ruedas
1	Set de 5 perfiles con 90 contenedores Picking Box tamaño 1
1	Set de 4 perfiles con 48 contenedores Picking Box tamaño 2
1	Kit de ruedas de goma antihuella sintética Ø 125 mm



ART.	A mm	P mm	H mm	 Sin ruedas	 set de ruedas	RAL	
BINCART1003	1067	668	1357	300	300	7016	

Compuesto por:

cant.	descripción
1	Carro desmontado sin ruedas
2	Set de 4 perfiles con 48 contenedores Picking Box tamaño 2
1	Kit de ruedas de goma antihuella sintética Ø 125 mm



RAL 7016

 CAPACIDAD

BIN CART



ART.	A mm	P mm	H mm	Sin ruedas	set de ruedas	RAL	
BINCART0701	761	668	1357	300	300	7016	

Compuesto por:

cant.	descripción
1	Carro desmontado sin ruedas
2	Par de soportes totales para Visual Box
2	Perfil de aluminio para Picking Box
2	Cajonera Visual Box con 3 cajones H=240 mm
2	Cajonera Visual Box con 4 cajones H=206 mm
4	Cajonera Visual Box con 5 cajones H=164 mm

cant.	descripción
6	Cajonera Visual Box con 6 cajones H=112 mm
2	Tope para cajonera Visual Box con 3 cajones
2	Tope para cajonera Visual Box con 4 cajones
4	Tope para cajonera Visual Box con 5 cajones
6	Tope para cajonera Visual Box con 6 cajones
1	Kit de ruedas de goma antihuella sintética Ø 125 mm



BIN CART



ART.	A mm	P mm	H mm	 Sin ruedas	 set de ruedas	RAL
BINCART1007	1067	668	1543	300	300	7016

Compuesto por:

cant.	descripción
1	Carro desmontado sin ruedas
1	Par de placas de soporte para perfiles de aluminio
3	Perfil de aluminio para Picking Box
1	Panel perforado/repisa con borde bloquea caja
1	Armario colgante con puerta
3	Barra gancho con 4 contenedores Picking Box tamaño 1
1	Kit de ruedas de goma antihuella sintética Ø 125 mm



ART.	A mm	P mm	H mm	 Sin ruedas	 set de ruedas	RAL
BINCART1006	1067	668	1965	300	300	7016

Compuesto por:

cant.	descripción
1	Carro desmontado sin ruedas
2	Par de placas de soporte para perfiles de aluminio
6	Perfil de aluminio para Picking Box
1	Kit de ruedas de goma antihuella sintética Ø 125 mm



RAL 7016

 CAPACIDAD

BIN CART



ART.	A mm	P mm	H mm	 Sin ruedas	 set de ruedas	RAL	
BINCART0704	761	668	1357	300	300	7016	

Compuesto por:

cant.	descripción
1	Carro desmontado sin ruedas
4	Panel perforado/repisa con borde bloquea caja
1	Kit de ruedas de goma antihuella sintética Ø 125 mm



ART.	A mm	P mm	H mm	 Sin ruedas	 set de ruedas	RAL	
BINCART1008	1067	668	1357	300	300	7016	

Compuesto por:

cant.	descripción
1	Carro desmontado sin ruedas
4	Panel perforado/repisa con borde bloquea caja
1	Kit de ruedas de goma antihuella sintética Ø 125 mm



ART.	A mm	P mm	H mm	 Sin ruedas	 set de ruedas	RAL	
BINCART1501	1552	668	1357	300	300	7016	

Compuesto por:

cant.	descripción
1	Carro desmontado sin ruedas
4	Panel perforado/repisa con borde bloquea caja
1	Kit de ruedas de goma antihuella sintética Ø 125 mm

BIN CART



ART.	A mm	P mm	H mm	 Sin ruedas	 set de ruedas	RAL	
BINCART0705	761	668	1965	300	300	7016	

Compuesto por:

cant.	descripción
1	Carro desmontado sin ruedas
6	Panel perforado/repisa con borde bloquea caja
1	Kit de ruedas de goma antihuella sintética Ø 125 mm



ART.	A mm	P mm	H mm	 Sin ruedas	 set de ruedas	RAL	
BINCART1009	1067	668	1965	300	300	7016	

Compuesto por:

cant.	descripción
1	Carro desmontado sin ruedas
6	Panel perforado/repisa con borde bloquea caja
1	Kit de ruedas de goma antihuella sintética Ø 125 mm



ART.	A mm	P mm	H mm	 Sin ruedas	 set de ruedas	RAL	
BINCART1502	1552	668	1965	300	300	7016	

Compuesto por:

cant.	descripción
1	Carro desmontado sin ruedas
6	Panel perforado/repisa con borde bloquea caja
1	Kit de ruedas de goma antihuella sintética Ø 125 mm

BIN CART



ART.	A mm	P mm	H mm	 Sin ruedas	 set de ruedas	RAL	
BINCART0706	761	668	1965	300	300	7016	

Compuesto por:

cant.	descripción
1	Carro desmontado sin ruedas
2	Panel perforado/repisa con borde bloquea caja
1	Perfil de aluminio para Picking Box
10	Gancho para cables P = 171 mm
1	Kit de ruedas de goma antihuella sintética Ø 125 mm



ART.	A mm	P mm	H mm	 Sin ruedas	 set de ruedas	RAL	
BINCART1010	1067	668	1965	300	300	7016	

Compuesto por:

cant.	descripción
1	Carro desmontado sin ruedas
2	Panel perforado/repisa con borde bloquea caja
1	Perfil de aluminio para Picking Box
10	Gancho para cables P = 171 mm
1	Kit de ruedas de goma antihuella sintética Ø 125 mm



ART.	A mm	P mm	H mm	 Sin ruedas	 set de ruedas	RAL	
BINCART1503	1552	668	1965	300	300	7016	

Compuesto por:

cant.	descripción
1	Carro desmontado sin ruedas
2	Panel perforado/repisa con borde bloquea caja
1	Perfil de aluminio para Picking Box
10	Gancho para cables P = 171 mm
1	Kit de ruedas de goma antihuella sintética Ø 125 mm



BIN CART



ART.	A mm	P mm	H mm	 Sin ruedas	 set de ruedas	RAL	
BINCART0707	761	668	1357	300	300	7016	

Compuesto por:

cant.	descripción
1	Carro desmontado sin ruedas
1	Perfil de aluminio para Picking Box
10	Gancho para cables P = 171 mm
1	Kit de ruedas de goma antihuella sintética Ø 125 mm



ART.	A mm	P mm	H mm	 Sin ruedas	 set de ruedas	RAL	
BINCART1011	1067	668	1357	300	300	7016	

Compuesto por:

cant.	descripción
1	Carro desmontado sin ruedas
1	Perfil de aluminio para Picking Box
10	Gancho para cables P = 171 mm
1	Kit de ruedas de goma antihuella sintética Ø 125 mm

Equipamiento excluido



ART.	A mm	P mm	H mm	 Sin ruedas	 set de ruedas	RAL	
BINCART1504	1552	668	1357	300	300	7016	

Compuesto por:

cant.	descripción
1	Carro desmontado sin ruedas
1	Perfil de aluminio para Picking Box
10	Gancho para cables P = 171 mm
1	Kit de ruedas de goma antihuella sintética Ø 125 mm



RAL 7016

 CAPACIDAD

BIN CART



ART.	A mm	P mm	H mm	Sin ruedas	set de ruedas	RAL	
BINCART0708	761	668	1357	300	300	7016	

Compuesto por:

cant.	descripción
1	Carro desmontado sin ruedas
2	Perfil de aluminio para Picking Box
6	Par de soportes P = 266 mm
1	Kit de ruedas de goma antihuella sintética Ø 125 mm



ART.	A mm	P mm	H mm	Sin ruedas	set de ruedas	RAL	
BINCART1012	1067	668	1357	300	300	7016	

Compuesto por:

cant.	descripción
1	Carro desmontado sin ruedas
2	Perfil de aluminio para Picking Box
6	Par de soportes P = 266 mm
1	Kit de ruedas de goma antihuella sintética Ø 125 mm

Equipamiento excluido



ART.	A mm	P mm	H mm	Sin ruedas	set de ruedas	RAL	
BINCART1505	1552	668	1357	300	300	7016	

Compuesto por:

cant.	descripción
1	Carro desmontado sin ruedas
2	Perfil de aluminio para Picking Box
6	Par de soportes P = 266 mm
1	Kit de ruedas de goma antihuella sintética Ø 125 mm



BIN CART



ART.	A mm	P mm	H mm	Sin ruedas	set de ruedas	RAL	
BINCART0709	761	668	1965	300	300	7016	

Compuesto por:

cant.	descripción
1	Carro desmontado sin ruedas
1	Panel perforado/repisa con borde bloquea caja
1	Kit porta rollo con papel Ø=240 mm
1	Repisa pequeña reversible
2	Perfil de aluminio para Picking Box
3	Par de soportes P = 421 mm
1	Kit de ruedas de goma antihuella sintética Ø 125 mm



ART.	A mm	P mm	H mm	Sin ruedas	set de ruedas	RAL	
BINCART1013	1067	668	1965	300	300	7016	

Compuesto por:

cant.	descripción
1	Carro desmontado sin ruedas
1	Panel perforado/repisa con borde bloquea caja
2	Armario colgante con puerta
2	Perfil de aluminio para Picking Box
3	Par de soportes P = 421 mm
1	Kit de ruedas de goma antihuella sintética Ø 125 mm



ART.	A mm	P mm	H mm	Sin ruedas	set de ruedas	RAL	
BINCART1506	1552	668	1965	300	300	7016	

Compuesto por:

cant.	descripción
1	Carro desmontado sin ruedas
1	Panel perforado/repisa con borde bloquea caja
1	Armario colgante con puerta
2	Repisa grande reversible
2	Perfil de aluminio para Picking Box
3	Par de soportes P = 421 mm
1	Kit de ruedas de goma antihuella sintética Ø 125 mm





RAL 7016

CAPACIDAD

BIN CART



ART.	A mm	P mm	H mm	 Sin ruedas	 set de ruedas	RAL	
BINCART1005	1067	668	1677	300	300	7016	

Compuesto por:

cant.	descripción
1	Carro desmontado sin ruedas
3	Panel no perforado/repisa
1	Panel perforado/repisa con borde bloquea caja
1	Par de escuadras en L
1	Articulación para placa

cant.	descripción
1	Placa porta monitor de acuerdo con standard VESA
1	Soporte toma múltiple de 4 compartimentos
1	Toma múltiple Schuko de 4 compartimentos
1	Cable de conexión Wieland Schuko/FR
1	Kit de ruedas de goma antihuella sintética Ø 125 mm

BIN CART



Contenedores excluidos



ART.	A mm	P mm	H mm	Sin ruedas	set de ruedas	RAL	
BINCART1004	1067	668	1357	300	300	7016	

Compuesto por:

cant.	descripción
1	Carro desmontado sin ruedas
3	Panel perforado/repisa con borde bloquea caja
1	Perfil de aluminio para Picking Box
1	Kit de ruedas de goma antihuella sintética Ø 125 mm

RAL 7016

CAPACIDAD

BIN CART



Banco excluido

ART.	A mm	P mm	H mm	 Sin ruedas	 set de ruedas	RAL	
BINCART1014	2513	850	2267	300	300	7016	

Compuesto por:

cant.	descripción
1	Carro desmontado sin ruedas
1	Kit de 2 soportes inclinados con guía
1	Lámpara doble
3	Panel perforado/repisa con borde bloquea caja
4	Kit de 2 contenedores Picking Box tamaño 3A2
2	Brazo articulado para montante

cant.	descripción
2	Placa porta monitor de acuerdo con standard VESA
1	Panel para Picking Box
5	Barra gancho con 4 contenedores Picking Box tamaño 1
1	Panel para Visual Box
2	Cajonera Visual Box con 6 cajones H=112 mm
1	Cajonera Visual Box con 5 cajones H=164 mm
1	Kit de ruedas de goma antihuella sintética Ø 125 mm

BIN CART



Banco excluido

ART.	A mm	P mm	H mm	 Sin ruedas	 set de ruedas	RAL	
BINCART1507	2998	850	2267	300	300	7016	

Compuesto por:

cant.	descripción
1	Carro desmontado sin ruedas
3	Panel perforado/repisa con borde bloquea caja
1	Kit de 2 soportes inclinados con guía
1	Lámpara doble
2	Brazo articulado para montante
2	Placa porta monitor de acuerdo con standard VESA
1	Panel para Picking Box

cant.	descripción
4	Barra gancho con 4 contenedores Picking Box tamaño 1
1	Panel para Visual Box
2	Cajonera Visual Box con 6 cajones H=112 mm
1	Cajonera Visual Box con 5 cajones H=164 mm
18	Contenedor de polipropileno Picking Box tamaño 2
3	Kit de 2 contenedores Picking Box tamaño 3A2
1	Kit de ruedas de goma antihuella sintética Ø 125 mm

 RAL 7016

 CAPACIDAD



Carro desmontado sin ruedas

ART.	A mm	P mm	H mm	KG	KG por lado	RAL	
FBC10070039	709	668	1201	300	150	7016	
FBC15070039	709	668	1809	300	150	7016	



Perfil de aluminio para Picking Box

ART.	A mm	P mm	H mm	material	KG		
FBC25070000	705	35	60	Aluminio	40		



Par de soportes parciales para Visual Box

ART.	A mm	P mm	H mm	KG	RAL		
FBC30070139	649	50	319	75	7016		



Par de soportes totales para Visual Box

ART.	A mm	P mm	H mm	KG	RAL		
FBC30070239	649	50	1153	150	7016		





Panel no perforado/repisa

Se puede utilizar como cierre de la base del carro

ART.	A mm	P mm	H mm	KG	RAL
FBL76580008	647	31	494	50	7035



Panel perforado/repisa con borde bloquea caja

ART.	A mm	P mm	H mm	Medida del orificio (mm)	Paso mm	RAL
FBL76080108	647	60	456	10x10	38	7035
FBL76080104	647	60	456	10x10	38	5012

Visual Box



Cajoneras Visual Box

ART.	unidad de venta	dim. totales			cajones			color	
		A mm	P mm	H mm	n.º	A mm	P mm		H mm
FAXVBCH00900001	2	600	69	77	9	59	44	49	Gris oscuro
FAXVBCH00600001	2	600	98	112	6	87	66	72	Gris oscuro
FAXVBCH00500001	1	600	141	164	5	113	100	110	Gris oscuro
FAXVBCH00400001	1	600	174	206	4	142	130	135	Gris oscuro
FAXVBCH00300001	1	600	209	240	3	190	146	164	Gris oscuro



Tope para cajonera Visual Box

ART.	apto para
FAXVBCHL0900099	FAXVBCH0090000
FAXVBCHL0600099	FAXVBCH0060000
FAXVBCHL0500099	FAXVBCH0050000
FAXVBCHL0400099	FAXVBCH0040000
FAXVBCHL0300099	FAXVBCH0030000



RAL 7016



RAL 7035





RAL 5012



CAPACIDAD



Carro desmontado sin ruedas

ART.	A mm	P mm	H mm	 KG	 por lado	RAL	
FBC10100039	1015	668	1201	300	150	7016	
FBC15100039	1015	668	1809	300	150	7016	



Perfil de aluminio para Picking Box

ART.	A mm	P mm	H mm	material	 KG	
FBC25100000	1011	35	60	Aluminio	40	



Panel no perforado/repisa

Se puede utilizar como cierre de la base del carro

ART.	A mm	P mm	H mm	 KG	RAL	
FBL76680008	953	31	494	50	7035	



Panel perforado/repisa con borde bloquea caja

ART.	A mm	P mm	H mm	Medida del orificio (mm)	Paso mm	RAL	
FBL76170108	953	60	456	10x10	38	7035	
FBL76170104	953	60	456	10x10	38	5012	



Set de 4 perfiles con 48 contenedores Picking Box tamaño 2

ART.	Para carro A mm	contenedores tamaño	color
FBC25100201	1015	2	Gris oscuro



Set de 5 perfiles con 90 contenedores Picking Box tamaño 1

ART.	Para carro A mm	contenedores tamaño	color
FBC25100101	1015	1	Gris oscuro



Par de placas de soporte para perfiles de aluminio

ART.	A mm	P mm	H mm	KG	RAL
FBC40100039	524	104	3	80	7016



1. Perfil de aluminio para Picking Box
2. Par de placas de soporte para perfiles de aluminio
3. Gancho para cables P = 221 mm



RAL 7016



RAL 7035





RAL 5012



CAPACIDAD



Carro desmontado sin ruedas

ART.	A mm	P mm	H mm	 KG	 KG por lado	RAL	
FBC10150039	1500	668	1201	300	150	7016	
FBC15150039	1500	668	1809	300	150	7016	



Perfil de aluminio para Picking Box

ART.	A mm	P mm	H mm	Para carro A mm	 KG	Para contenedores tamaño	material	
FBC25150000	1496	35	60	1500	40	1/2	Aluminio	



Panel perforado/repisa con borde bloquea caja

ART.	A mm	P mm	H mm	Medida del orificio (mm)	Paso mm	RAL	
FBL76320108	1438	60	456	10x10	38	7035	
FBL76320104	1438	60	456	10x10	38	5012	

A= 700 MM

A= 1000 MM

A= 1500 MM



Gancho porta cables

ART.	A mm	P mm	H mm	KG
FBC35100099	28	171	84	10
FBC35150099	28	221	84	10
FBC35200099	28	271	84	10



Par soportes

ART.	dim. totales			dim. útiles	KG	RAL
	A mm	P mm	H mm	P mm		
FBC45030008	36	300	136	266	70	7035
FBC45040008	36	455	136	421	50	7035



Kit de ruedas

ART.	Ø mm	KG	KG	H mm	material	🔄	🛑
FKRD1002107	100	75	225	128	Goma standard	2	2
FKRB1252107	125	100	300	155	Goma standard	2	2
FKRU1252101	125	100	300	155	Goma antihuella sintética	2	2
FKRS1252101	125	250	750	155	Goma elástica	2	2

IRONTEAM

ver página 90



FBL95410000



FBLIT008039



FBLIT004039



FBLIT010039



FBLIT013000



FBLIT017039



FBLET012007



FBLET004007



FBLET005007



FBLET016007



RUEDA GIRATORIA CONFRENO



RUEDA FIJA



RAL 7016



RAL 7035



RAL 5012



CAPACIDAD

SYSTEM ST

ESTANTERÍAS



Courtesy of Animo



Fácil de montar

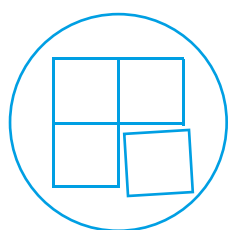

Componible

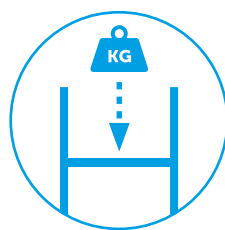

**Capacidad estantes
hasta 300 kg**



**Capacidad arco
2300 kg**

SYSTEM ST



ART.	A mm	P mm	H mm	Acabado
ST2001	2115	523	2003	Galvanizado

cant.	descripción
3	Lateral con 3 travesaños
2	Kit de 5 estantes ranurados



ART.	A mm	P mm	H mm	Acabado
ST2601	2715	423	2003	Galvanizado

cant.	descripción
3	Lateral con 3 travesaños
2	Kit de 3 pares de soportes porta neumáticos



Kit de 5 refuerzos para estantes ranurados

ART.	A mm	P mm	H mm	Acabado
FUF20000199	993	50	33	Galvanizado

Kit de 3 pares de soportes porta neumáticos

ART.	A mm	P mm	H mm	KG	Acabado
FST95900199	1300	32	100	50	Galvanizado

Kit de 5 estantes ranurados

ART.	A mm	P mm	H mm	KG	Acabado
FST10402099	1000	400	35	120	Galvanizado
FST10502099	1000	500	35	120	Galvanizado

Lateral con travesaños

ART.	P mm	H mm	Acabado
FST02034099	423	2003	Galvanizado
FST02035099	523	2003	Galvanizado

STORAGE DOMINO

ESTANTERÍAS

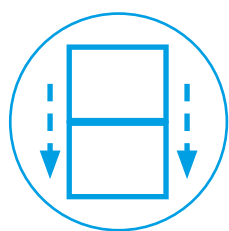

Superponibles

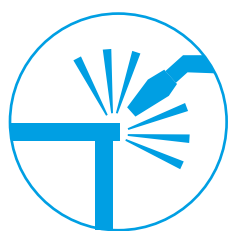

Estructura soldada



**Capacidad módulo
hasta 1600 kg**



Tope anticaída

STORAGE DOMINO



ART.	A mm	P mm	H mm	RAL	
FED30440101	1025	355	885	7000	

Compuesto por:

cant.	descripción
1	Estantería de 16 puestos para contenedores tamaño 3
16	Contenedor de polipropileno Picking Box tamaño 3

Superposición



N. bastidores superpuestos	 de cada bastidor	 de cada box
2	960	60
3	640	40



ART.	A mm	P mm	H mm	RAL	
FED40540101	1765	500	885	7000	

Compuesto por:

cant.	descripción
1	Estantería de 20 puestos para contenedores tamaño 4
20	Contenedor de polipropileno Picking Box tamaño 4

Superposición

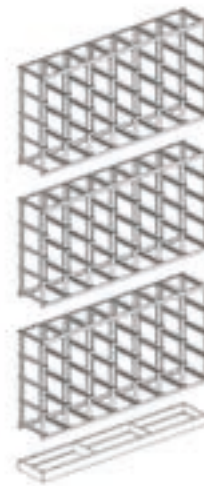

N. bastidores superpuestos	 de cada bastidor	 de cada box
3	1600	80

STORAGE DOMINO



ART.	A mm	P mm	H mm	RAL	
FED30440201	1025	355	885	7000	

Compuesto por:

cant.	descripción
1	Estantería de 16 puestos para contenedores tamaño 3
16	Contenedor de metal tamaño 3

Superposición



N. bastidores superpuestos	 de cada bastidor	 de cada box
2	960	60
3	640	40



ART.	A mm	P mm	H mm	RAL	
FED40540201	1765	500	885	7000	

Compuesto por:

cant.	descripción
1	Estantería de 20 puestos para contenedores tamaño 4
20	Contenedor de metal tamaño 4

Superposición

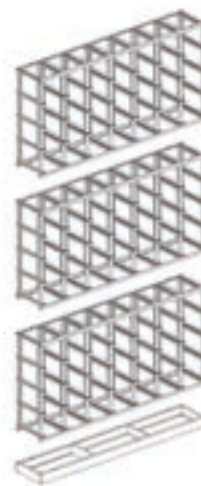

N. bastidores superpuestos	 de cada bastidor	 de cada box
3	1600	80

STORAGE DOMINO

COMPONENTES



Estantería vacía

ART.	A mm	P mm	H mm	RAL	
FED30440A01	1025	310	885	7000	



Estantería vacía

ART.	A mm	P mm	H mm	RAL	
FED40540A01	1765	460	885	7000	



Tapa antipolvo

ART.	A mm	P mm	H mm	RAL	
FED90340001	1020	315	20	7000	



Tapa antipolvo

ART.	A mm	P mm	H mm	RAL	
FED90450001	1765	465	20	7000	



Zócalo de apoyo

ART.	A mm	P mm	H mm	RAL	
FED92340001	1020	313	85	7000	



Zócalo de apoyo

ART.	A mm	P mm	H mm	RAL	
FED92450001	1765	463	85	7000	

 RAL 7000

 CAPACIDAD

STEEL

CAJONES, CONTENEDORES Y CONTENEDORES DE METAL

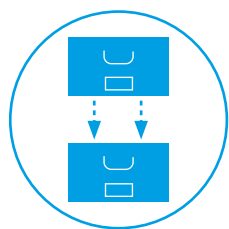

Apilables

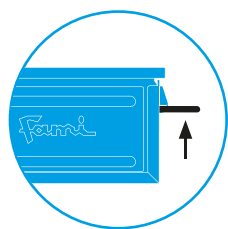

Asa bloqueo de 90°

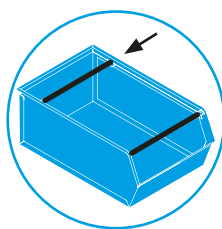

Travesaño de elevación

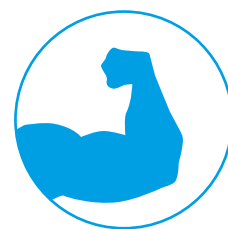

Robustos



272-3A2



272-3



272-4



272-4A5



272-5

ART.	unidad de venta	tamaño	dim. totales			dim. útiles			L	RAL	
			Amm	Pmm	Hmm	Amm	Pmm	Hmm			
FLA33200A01	10	272-3A2	325	210	145	300	200	130	8,7	7000	
FLA41200A01	8	272-3	325	210	200	300	200	185	12	7000	
FLA65200A01	6	272-4	480	315	200	450	300	185	27	7000	
FLA73200A01	4	272-4A5	480	315	300	450	300	280	40,5	7000	
FLA89200A01	6	272-5	660	480	300	630	450	280	85	7000	





1



2



3A2



3

ART.	unidad de venta	tamaño	dim. totales			dim. útiles			L	RAL
			A mm	P mm	H mm	A mm	P mm	H mm		
FLS17000A01	20	1	105	165	75	95	140	65	1	7000
FLS25000A01	20	2	150	235	125	140	195	115	3,8	7000
FLS33000A01	10	3A2	210	350	145	195	300	135	9,4	7000
FLS41000A01	8	3	210	350	200	200	300	185	12,5	7000



3P4



4A2



4



4A5

ART.	unidad de venta	tamaño	dim. totales			dim. útiles			L	RAL
			A mm	P mm	H mm	A mm	P mm	H mm		
FLS49000A01	9	3P4	210	550	200	200	450	185	18	7000
FLS57000A01	8	4A2	310	500	145	300	450	135	20	7000
FLS65000A01	6	4	310	510	200	300	450	185	28	7000
FLS73000A01	4	4A5	310	525	315	300	450	280	42	7000

TRAVESAÑO DE ELEVACIÓN COMBINADO CON ASA DE BLOQUEO DE 90°





5P4



5



5P4



5

ART.	unidad de venta	tamaño	dim. totales			dim. útiles			N. correderas	L	RAL	
			A mm	P mm	H mm	A mm	P mm	H mm				
FLS81000A01	6	5P4	480	540	300	450	450	280	-	63	7000	
FLS89000A01	6	5	480	725	295	450	630	280	-	88	7000	
FLS81100A01	4	5P4	480	540	385	450	450	280	2	63	7000	
FLS89100A01	4	5	480	725	385	450	630	280	2	88	7000	



4



4A5



5P4



5

ART.	unidad de venta	tamaño	dim. totales			dim. útiles			L	RAL	
			A mm	P mm	H mm	A mm	P mm	H mm			
FLS65010A01	6	4	310	510	200	300	450	185	28	7000	
FLS73010A01	4	4A5	310	525	315	300	450	280	42	7000	
FLS81010A01	6	5P4	480	540	300	450	450	280	63	7000	
FLS89010A01	6	5	480	725	295	450	630	280	88	7000	

Aplicaciones Especiales

CONTENEDORES CON DOBLE TRAVESAÑO



sistema de recogida con carro elevador

CONTENEDORES CON CORREDERA



sistema de recogida con carro elevador





Contenedor con fondo de apertura con rodillos

ART.	A mm	P mm	H mm	KG	RAL
FML01210001	1095	865	1265	2000	7000

Contenedor con fondo de apertura con rodillos

ART.	A mm	P mm	H mm	KG	RAL
FML01110001	1095	865	915	2000	7000

CONTENEDORES CON FONDO DE APERTURA CON RODILLOS

Levantados con un carro elevador mediante las cuatro asas soldadas al borde superior, permiten descargar el material mediante el fondo de apertura con rodillos (87 % de apertura). La apertura se realiza de un modo fácil y seguro a través de la palanca situada en el lado de 800 mm, mientras que el cierre se realiza mediante un dispositivo especial formado por palancas y rodillos de acero.





Contenedor de frente abierto

ART.	unidad de venta	A mm	P mm	H mm	 KG	RAL	
FML05100A01	3	830	680	600	1000	7000	



RAL 7000



CAPACIDAD

EURO BOX

NESTABLE BOX LIGHT

PICKING BOX-VISUAL BOX

CAJONES Y CONTENEDORES DE PLÁSTICO

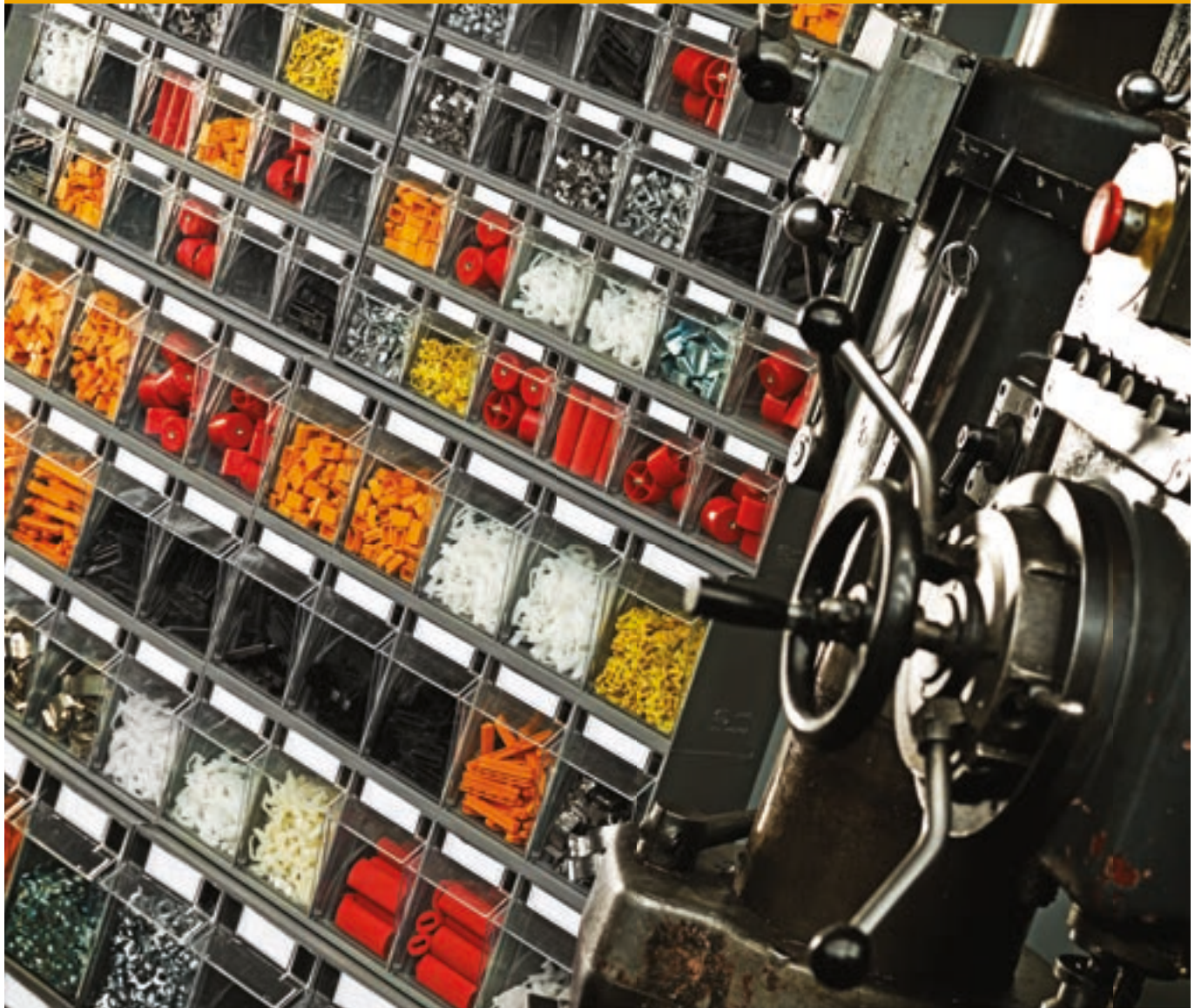

Polipropileno



Ecogreen

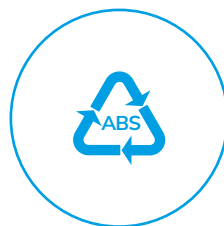

ABS



Poliestireno



Polietileno



300 x 200 mm

ART.	dim. totales			dim. útiles			L	color	
	A mm	P mm	H mm	A mm	P mm	H mm			
FAXEB3212A05101	298	200	120	259	160	116	5	Gris oscuro	
FAXEB3217A05101	298	198	170	259	160	166	7	Gris oscuro	
FAXEB32HG005101	298	192	15	-	-	-	-	Gris oscuro	



400 x 300 mm

ART.	dim. totales			dim. útiles			L	color	
	A mm	P mm	H mm	A mm	P mm	H mm			
FAXEB4312A05101	400	300	120	355	255	116	10	Gris oscuro	
FAXEB4317A05101	400	300	170	355	255	166	15	Gris oscuro	
FAXEB4322A05101	400	300	220	355	255	216	20	Gris oscuro	
FAXEB4332A05101	400	300	325	355	255	321	30	Gris oscuro	
FAXEB43HG005101	400	300	-	-	-	-	-	Gris oscuro	



600 x 400 mm

ART.	dim. totales			dim. útiles			L	color
	A mm	P mm	H mm	A mm	P mm	H mm		
FAXEB6412A05101	600	400	120	555	355	116	20	Gris oscuro
FAXEB6417A05101	600	400	170	555	355	166	30	Gris oscuro
FAXEB6422A05101	600	400	220	555	355	216	40	Gris oscuro
FAXEB6428A05101	600	400	280	555	355	276	53	Gris oscuro



600 x 400 mm

ART.	dim. totales			dim. útiles			L	color
	A mm	P mm	H mm	A mm	P mm	H mm		
FAXEB6432A05101	600	400	325	555	355	321	60	Gris oscuro
FAXEB6443B05101	600	400	430	555	355	426	90	Gris oscuro
FAXEB64HG005101	600	400	-	-	-	-	-	Gris oscuro



Carro para cajas Euro Box con base de acero con ruedas

ART.	A mm	P mm	H mm	KG	Ruedas			Acabado
					🔧	🔧	Ø	
FCP20110299	698	415	870	150	1	3	100	Goma standard Galvanizado



Carro para cajas Euro Box con base de acero con ruedas

ART.	A mm	P mm	H mm	KG	Ruedas			Acabado
					🔧	🔧	Ø	
FCP20110199	615	415	165	150	1	3	100	Goma standard Galvanizado



800 x 600 mm

ART.	dim. totales			dim. útiles			L	color
	A mm	P mm	H mm	A mm	P mm	H mm		
FAXEB8612C05101	800	600	120	755	555	101	49	Gris oscuro
FAXEB8617C05101	800	600	170	755	555	151	69	Gris oscuro
FAXEB8622C05101	800	600	220	755	555	201	90	Gris oscuro



800 x 600 mm

ART.	dim. totales			dim. útiles			L	color
	A mm	P mm	H mm	A mm	P mm	H mm		
FAXEB8632C05101	800	600	325	755	555	306	130	Gris oscuro
FAXEB8643C05101	800	600	430	755	555	411	175	Gris oscuro
FAXEB86SE005101	800	600	-	-	-	-	-	Gris oscuro



Kit de ruedas

ART.	Ø mm	KG	KG	H mm	material	↺	↻
FKRD1002107	100	75	225	128	Goma standard	2	2



Set de tornillos para fijación ruedas en cajón Euro Box

ART.	ud. por paquete
FVT01380000	16



RUEDA GIRATORIA



RUEDA GIRATORIA CONFRENO



RUEDA FIJA



GALVANIZADO



CAPACIDAD



CAPACIDAD



400 x 300 mm

ART.	dim. totales			dim. útiles			L	color	
	A mm	P mm	H mm	A mm	P mm	H mm			
FAXEB4312A05401	400	300	120	355	255	116	10	Gris oscuro	
FAXEB4317A05401	400	300	170	355	255	166	15	Gris oscuro	
FAXEB4322A05401	400	300	220	355	255	216	20	Gris oscuro	
FAXEB4332A05401	400	300	325	355	255	321	30	Gris oscuro	
FAXEB43HG005401	400	300	-	-	-	-	-	Gris oscuro	



600 x 400 mm

ART.	dim. totales			dim. útiles			L	color	
	A mm	P mm	H mm	A mm	P mm	H mm			
FAXEB6412A05401	600	400	120	555	355	116	20	Gris oscuro	
FAXEB6417A05401	600	400	170	555	355	166	30	Gris oscuro	
FAXEB6422A05401	600	400	220	555	355	216	40	Gris oscuro	
FAXEB6432A05401	600	400	325	555	355	321	60	Gris oscuro	
FAXEB64HG005401	600	400	-	-	-	-	-	Gris oscuro	

NESTABLE BOX LIGHT POLIPROPILENO



600 x 400 mm

ART.	dim. totales			dim. útiles			L	color	
	A mm	P mm	H mm	A mm	P mm	H mm			
FAXNL6420B05101	600	400	200	453	336	197	32	Gris oscuro	
FAXNL6430B05101	600	400	300	453	336	297	50	Gris oscuro	
FAXNL6440B05101	600	400	400	453	336	397	70	Gris oscuro	
FAXNL64SE005101	600	400	-	-	-	-	-	Gris oscuro	

PICKING BOX

ECOGREEN



ART.	unidad de venta	tamaño	dim. totales			dim. útiles			L	color	
			A mm	P mm	H mm	A mm	P mm	H mm			
FAXPBC001A05401	50	1	100	170	75	88	133	65	1	Gris oscuro	
FAXPBC002A05401	54	2	150	230	125	127	191	110	3,8	Gris oscuro	
FAXPBC3A2B05401	21	3A2	210	350	145	180	270	130	9,4	Gris oscuro	
FAXPBC003B05401	15	3	210	350	200	180	270	183	12,5	Gris oscuro	
FAXPBC004B05401	10	4	310	500	200	282	425	183	28	Gris oscuro	



1



2



3A2



3



4A2

ART.	unidad de venta	tamaño	dim. totales			dim. útiles			L	color
			A mm	P mm	H mm	A mm	P mm	H mm		
FAXPBC001A05101	50	1	100	170	75	88	133	65	1	Gris oscuro
FAXPBC001A05102	50	1	100	170	75	88	133	65	1	Verde
FAXPBC001A05103	50	1	100	170	75	88	133	65	1	Rojo
FAXPBC001A05104	50	1	100	170	75	88	133	65	1	Azul
FAXPBC001A05105	50	1	100	170	75	88	133	65	1	Amarillo
FAXPBC002A05101	54	2	150	230	125	127	191	110	3,8	Gris oscuro
FAXPBC002A05102	54	2	150	230	125	127	191	110	3,8	Verde
FAXPBC002A05103	54	2	150	230	125	127	191	110	3,8	Rojo
FAXPBC002A05104	54	2	150	230	125	127	191	110	3,8	Azul
FAXPBC002A05105	54	2	150	230	125	127	191	110	3,8	Amarillo
FAXPBC3A2B05101	21	3A2	210	350	145	180	270	130	9,4	Gris oscuro
FAXPBC3A2B05102	21	3A2	210	350	145	180	270	130	9,4	Verde
FAXPBC3A2B05103	21	3A2	210	350	145	180	270	130	9,4	Rojo
FAXPBC3A2B05104	21	3A2	210	350	145	180	270	130	9,4	Azul
FAXPBC3A2B05105	21	3A2	210	350	145	180	270	130	9,4	Amarillo
FAXPBC003B05101	15	3	210	350	200	180	270	183	12,5	Gris oscuro
FAXPBC003B05102	15	3	210	350	200	180	270	183	12,5	Verde
FAXPBC003B05103	15	3	210	350	200	180	270	183	12,5	Rojo
FAXPBC003B05104	15	3	210	350	200	180	270	183	12,5	Azul
FAXPBC003B05105	15	3	210	350	200	180	270	183	12,5	Amarillo
FAXPBC4A2B05101	14	4A2	310	500	145	282	425	134	20	Gris oscuro
FAXPBC4A2B05102	14	4A2	310	500	145	282	425	134	20	Verde
FAXPBC4A2B05103	14	4A2	310	500	145	282	425	134	20	Rojo
FAXPBC4A2B05104	14	4A2	310	500	145	282	425	134	20	Azul
FAXPBC4A2B05105	14	4A2	310	500	145	282	425	134	20	Amarillo



4



4A5



5P4



5

ART.	unidad de venta	tamaño	dim. totales			dim. útiles			L	color
			A mm	P mm	H mm	A mm	P mm	H mm		
FAXPBC004B05101	10	4	310	500	200	282	425	183	28	Gris oscuro
FAXPBC004B05102	10	4	310	500	200	282	425	183	28	Verde
FAXPBC004B05103	10	4	310	500	200	282	425	183	28	Rojo
FAXPBC004B05104	10	4	310	500	200	282	425	183	28	Azul
FAXPBC004B05105	10	4	310	500	200	282	425	183	28	Amarillo
FAXPBC4A5B05101	6	4A5	310	500	300	282	425	285	42	Gris oscuro
FAXPBC4A5B05102	6	4A5	310	500	300	282	425	285	42	Verde
FAXPBC4A5B05103	6	4A5	310	500	300	282	425	285	42	Rojo
FAXPBC4A5B05104	6	4A5	310	500	300	282	425	285	42	Azul
FAXPBC4A5B05105	6	4A5	310	500	300	282	425	285	42	Amarillo
FAXPBZ5P4E05101	1	5P4	472	535	300	432	435	281	63	Gris oscuro
FAXPBZ5P4E05102	1	5P4	472	535	300	432	435	281	63	Verde
FAXPBZ5P4E05103	1	5P4	472	535	300	432	435	281	63	Rojo
FAXPBZ5P4E05104	1	5P4	472	535	300	432	435	281	63	Azul
FAXPBZ5P4E05105	1	5P4	472	535	300	432	435	281	63	Amarillo
FAXPBZ005E05101	1	5	472	720	300	434	615	275	88	Gris oscuro
FAXPBZ005E05102	1	5	472	720	300	434	615	275	88	Verde
FAXPBZ005E05103	1	5	472	720	300	434	615	275	88	Rojo
FAXPBZ005E05104	1	5	472	720	300	434	615	275	88	Azul
FAXPBZ005E05105	1	5	472	720	300	434	615	275	88	Amarillo

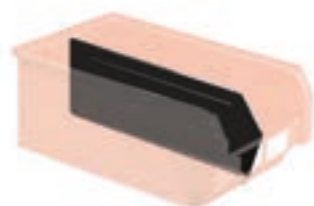

Divisor longitudinal de plástico

ART.	unidad de venta	para contenedor tamaño	A mm	H mm	color
FAXPBDC3A207107	10	3A2	300	105	Negro
FAXPBDC00307107	10	3	305	160	Negro
FAXPBDC00407107	10	4	460	160	Negro



ART.	unidad de venta	dim. totales			cajones				color
		A mm	P mm	H mm	n.º	A mm	P mm	H mm	
FAXVBCH00900001	2	600	69	77	9	59	44	49	Gris oscuro
FAXVBCH00600001	2	600	98	112	6	87	66	72	Gris oscuro
FAXVBCH00500001	1	600	141	164	5	113	100	110	Gris oscuro
FAXVBCH00400001	1	600	174	206	4	142	130	135	Gris oscuro
FAXVBCH00300001	1	600	209	240	3	190	146	164	Gris oscuro
FAXVBCH00200001	1	600	311	353	2	285	219	246	Gris oscuro

Tope para cajonera Visual Box

ART.	apto para
FAXVBCHL0900099	FAXVBCH009000
FAXVBCHL0600099	FAXVBCH006000
FAXVBCHL0500099	FAXVBCH005000
FAXVBCHL0400099	FAXVBCH004000
FAXVBCHL0300099	FAXVBCH003000
FAXVBCHL0200099	FAXVBCH002000



Estantería vacía de pared para cajoneras Visual Box

ART.	A mm	P mm	H mm	RAL
FVBSW1500000001	604	41	1502	7000
FVBSW1950000001	604	41	1952	7000



Base para estantería Visual Box

ART.	A mm	P mm	H mm	RAL
FVBSBASE0000001	600	300	100	7000





Alfombra antideslizante de polietileno

ART.	A mm	P mm	H mm	color
FAXSMTC08004001	800	400	25	Gris oscuro
FAXSMTC08004006	800	400	25	Rojo ladrillo

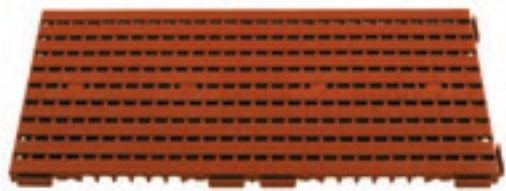

Alfombra antideslizante perforada de polietileno

ART.	A mm	P mm	H mm	color
FAXSMTA08004001	800	400	25	Gris oscuro
FAXSMTA08004006	800	400	25	Rojo ladrillo



Empalme para alfombra de polietileno

ART.	A mm	P mm	H mm	color
FAXSMRC04001205	400	120	25	Amarillo

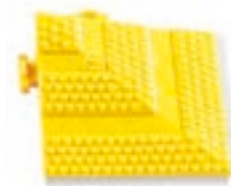

Ángulo para alfombra de polietileno

ART.	A mm	P mm	H mm	color
FAXSMAN01201205	120	120	25	Amarillo



Clip para enganchar la alfombra

ART.	P mm	H mm	Acabado
FAXSMCL00000099	10	14	Galvanizado



GALVANIZADO



RAL 7000

7 *GEAR*
GARAGE







Características

Todo parte de la superficie

Los módulos inferiores disponen de una superficie con profundidad de 630 mm que permite disponer de espacios amplios para poder trabajar en comodidad.

El desplazamiento de la puerta

Los armarios de puertas correderas aumentan la capacidad de almacenamiento del puesto de trabajo reduciendo los volúmenes y los obstáculos que derivan del uso de armarios y puertas batientes.



Courtesy of Trident Motorsport



El armario secreto

El armario técnico está ideado para ocultar en el interior rodillos para carretes y cables eléctricos, para que así sean visibles solo los componentes necesarios para el trabajo.

El basculante del Garaje

Aperturas basculantes pueden ser introducidas en los módulos inferiores para aprovechar espacios que de lo contrario serán inutilizados. Facilitan la diferenciación de los residuos, contribuyendo a mantener el puesto de trabajo limpio y en orden.

Atrás del ángulo

El módulo de ángulo puede enriquecerse con un máximo de 4 tomas eléctricas y 2 carretes. Permite aprovechar al máximo los espacios y disponer de una superficie de trabajo de dimensiones notables.



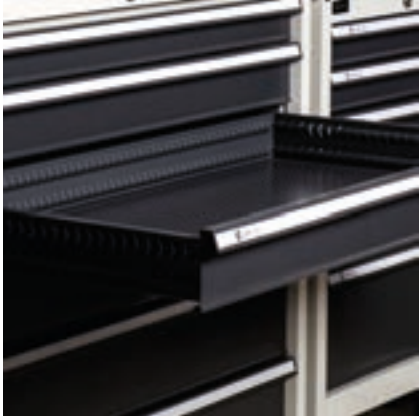

El cajón de las maravillas

Extracción del 100% y capacidad de 70 kg hacen que los cajones sean el depósito ideal para herramientas y equipos para el trabajo. La extracción total permite tener una visual completa del interior y facilita la extracción del material almacenado.



Autoportante

Todas las soluciones que componen Gear Garage no necesitan fijación en la pared. Las diferentes estructuras como módulos y colgantes son autoportantes.



Almacenamiento suspendido

El colgante con apertura abatible silenciada puede ser instalado en la pared normal o perforada y permite tener a disposición un lugar adicional para la organización del material de trabajo.



Módulos

El sistema modular de Gear Garage permite la integración de varios módulos para crear estructuras que pueden adaptarse fácilmente a las dimensiones del ambiente en el que se deben instalar. Los módulos están disponibles en 7 diferentes anchos, desde un mínimo de 512 mm a un máximo de 2040 mm, y se subdividen en módulos base, superficies de trabajo, colgantes, armarios, cajoneras y angulares.

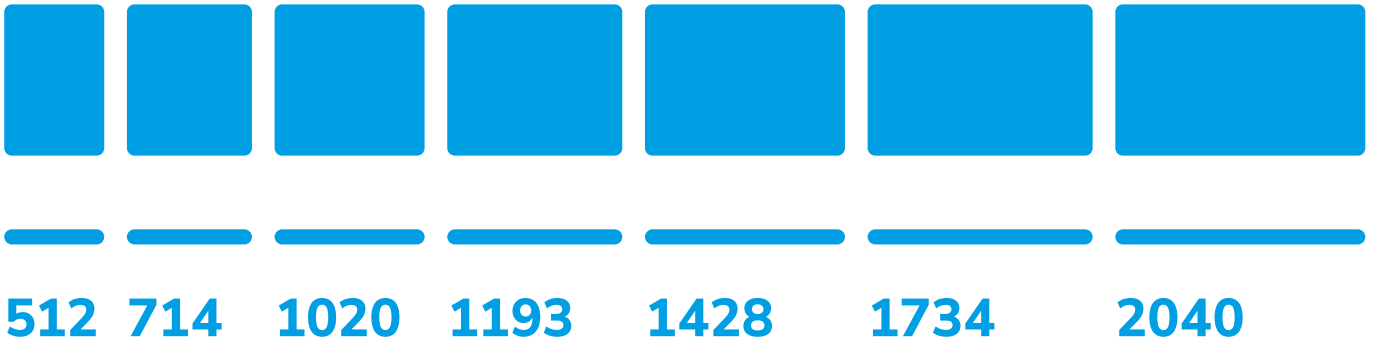

Top de distintos tipos



Acero **Inox** satinado

Acero **Engomado**

Madera **Multiplex**

Garantía



La garantía de 10 años de los productos Fami refleja el uso de materiales de calidad y el cuidado y la dedicación en la fabricación para que nuestros muebles sean fiables y duren en el tiempo.



Courtesy of Trident Motorsport

¡Todos los colores más uno!

En base al ambiente en el que se ha instalado o en base a los colores empresariales, Gear Garage puede ser de uno o de dos colores. De hecho, están a disposición hasta 12 colores RAL para personalizar la estructura y los frentes.

Estructura

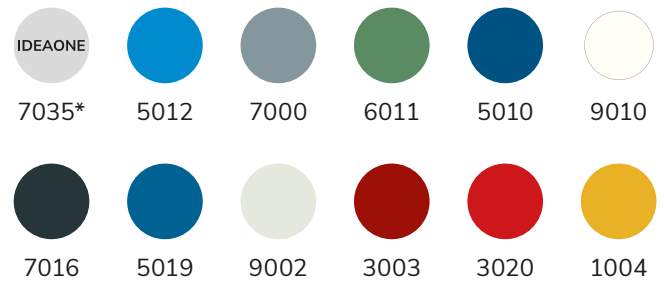

Frentes

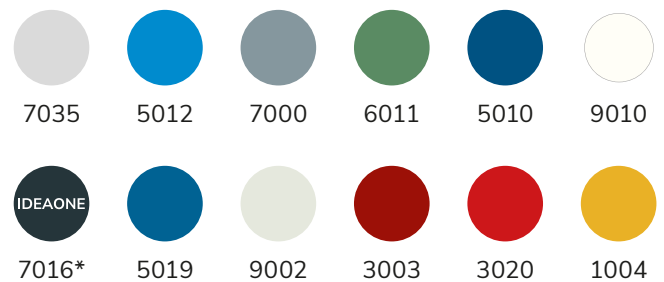

La estructura y los frentes en los colores **Ideaone RAL 7035 + RAL 7016 están listos en el almacén.





ART.	A mm	P mm	H mm	Top	RAL
GARAGE086	3297	2684	2000	Inox satinado	7035+7016
GARAGE087	3297	2684	2000	Acero engomado	7035+7016

Compuesto por:

cant.	descripción
2	Armario de puerta batiente
4	Kit de 2 estantes ranurados
2	Par de tiras de relleno para armario
2	Armario con 6 cajones 1x75 2x100 2x150 1x200
1	Armario con 5 cajones 2x75 1x100 1x150 1x200
1	Asa de tubo
1	Kit de ruedas de goma antihuella sintética Ø 125 mm
1	Kit taponamiento para armario con ruedas
1	Armario con compartimiento de residuos con puerta batiente
1	Porta rollo con papel
1	Escotilla para residuos
1	Pata de ángulo
1	Toma múltiple Schuko de 4 compartimentos
1	Cable de conexión Wieland Schuko/FR

cant.	descripción
1	Armario de puerta batiente
1	Estante regulable con soportes
5	Kit 4 pies regulables
1	Top de acero inox satinado L=2040 mm
1	Top de acero inox satinado para ángulo L=714 mm
1	Top de acero inox satinado L=1428 mm
2	Kit tornillos de fijación
4	Par de montantes
2	Montante central
2	Panel perforado/repisa con borde bloquea caja
4	Panel perforado/repisa con borde bloquea caja
2	Unidad de pared de apertura basculante sin cerradura
1	Colgante abatible
1	Unidad de pared de apertura basculante sin cerradura



ART.	A mm	P mm	H mm	Top	RAL
GARAGE088	8976	630	2000	Inox satinado	7035+7016
GARAGE089	8976	630	2000	Acero engomado	7035+7016

Compuesto por:

cant.	descripción
2	Armarios con puertas correderas
4	Kit de 4 estantes ranurados
2	Armario con 6 cajones 1x75 2x100 2x150 1x200
1	Armario con 5 cajones 2x75 1x100 1x150 1x200
1	Kit taponamiento para armario con ruedas
1	Asa de tubo
1	Kit de ruedas de goma antihuella sintética Ø 125 mm
1	Pata reversible
1	Armarios con puertas correderas
2	Estante ranurado
1	Armario con compartimiento de residuos con puerta batiente
1	Escotilla para residuos
1	Porta rollo con papel
9	Kit 4 pies regulables

cant.	descripción
2	Top de acero inox satinado L=1428 mm
1	Top de acero inox satinado L=2040 mm
3	Kit tornillos de fijación
5	Par de montantes
3	Montante central
4	Panel perforado/repisa con borde bloquea caja
2	Panel perforado electric
2	Panel perforado/repisa con borde bloquea caja
2	Toma múltiple Schuko de 4 compartimentos
2	Toma múltiple Schuko de 2 compartimentos
1	Cable de conexión Wieland con clavijas in/out
1	Cable de conexión Wieland Schuko/FR
2	Unidad de pared de apertura basculante sin cerradura
2	Unidad de pared de apertura basculante sin cerradura





ART.	A mm	P mm	H mm	Top	RAL
GARAGE090	3063	630	2000	Inox satinado	7035+7016
GARAGE091	3063	630	2000	Acero engomado	7035+7016

Compuesto por:

cant.	descripción	cant.	descripción
1	Armario de puertas batientes	1	Porta rollo con papel
1	Kit de 4 estantes ranurados	1	Escotilla para residuos
1	Par de tiras de relleno para armario	2	Kit 4 pies regulables
1	Armario con 6 cajones 1x75 2x100 2x150 1x200	1	Top de acero inox satinado L=2040 mm
1	Armario con 5 cajones 2x75 1x100 1x150 1x200	1	Kit tornillos de fijación
1	Asa de tubo	1	Par de montantes
1	Kit de ruedas de goma antihuella sintética Ø 125 mm	1	Montante central
1	Kit taponamiento para armario con ruedas	2	Panel perforado/repisa con borde bloquea caja
1	Armario con compartimiento de residuos con puerta batiente	2	Unidad de pared de apertura basculante sin cerradura



ART.	A mm	P mm	H mm	Top	RAL
GARAGE092	2142	630	2000	Inox satinado	7035+7016
GARAGE093	2142	630	2000	Acero engomado	7035+7016

Compuesto por:

cant.	descripción
1	Armario con compartimiento de residuos con puerta batiente
1	Escotilla para residuos
1	Porta rollo con papel
1	Armario con 6 cajones 1x75 2x100 2x150 1x200
1	Armario de puerta batiente
1	Estante regulable con soportes
3	Kit 4 pies regulables
1	Top de acero inox satinado L=714 mm
1	Top de acero inox satinado L=1428 mm
2	Kit tornillos de fijación
2	Par de montantes
1	Montante central
3	Panel perforado/repisa con borde bloquea caja
1	Unidad de pared de apertura basculante sin cerradura
1	Unidad de pared de apertura basculante sin cerradura



ART.	A mm	P mm	H mm	Top	RAL
GARAGE094	1940	630	2000	Inox satinado	7035+7016
GARAGE095	1940	630	2000	Acero engomado	7035+7016

Compuesto por:

cant.	descripción
1	Armario de puerta batiente
2	Kit de 2 estantes ranurados
1	Par de tiras de relleno para armario
1	Armario con 6 cajones 1x75 2x100 2x150 1x200
1	Armario de puerta batiente
1	Estante regulable con soportes
2	Kit 4 pies regulables
1	Top de acero inox satinado L=1428 mm
1	Kit tornillos de fijación
1	Par de montantes
1	Montante central
2	Panel perforado/repisa con borde bloquea caja
1	Unidad de pared de apertura basculante sin cerradura



ART.	A mm	P mm	H mm	Top	RAL
GARAGE104	2757	630	2000	Inox satinado	7035+7016
GARAGE105	2757	630	2000	Acero engomado	7035+7016

Compuesto por:

cant.	descripción	cant.	descripción
1	Armario de puertas batientes	1	Top de acero inox satinado L=1734 mm
1	Kit de 4 estantes ranurados	1	Kit tornillos de fijación
1	Par de tiras de relleno para armario	1	Par de montantes
1	Armario con 6 cajones 1x75 2x100 2x150 1x200	1	Montante central
1	Armario técnico con puerta batiente	1	Panel perforado/repisa con borde bloquea caja
1	Toma múltiple Schuko de 4 compartimentos	1	Panel perforado/repisa con borde bloquea caja
1	Cable de conexión Wieland Schuko/FR	1	Unidad de pared de apertura basculante sin cerradura
2	Kit 4 pies regulables	1	Unidad de pared de apertura basculante sin cerradura



ART.	A mm	P mm	H mm	Top	RAL
GARAGE096	1940	630	2000	Inox satinado	7035+7016
GARAGE097	1940	630	2000	Acero engomado	7035+7016

Compuesto por:

cant.	descripción
1	Armario de puerta batiente
2	Kit de 2 estantes ranurados
1	Par de tiras de relleno para armario
1	Armario con 6 cajones 1x75 2x100 2x150 1x200
1	Armario con compartimiento de residuos con puerta batiente
1	Escotilla para residuos
1	Porta rollo con papel
2	Kit 4 pies regulables
1	Top de acero inox satinado L=1428 mm
1	Kit tornillos de fijación
1	Par de montantes
1	Montante central
2	Panel perforado/repisa con borde bloquea caja
1	Unidad de pared de apertura basculante sin cerradura



ART.	A mm	P mm	H mm	Top	RAL
GARAGE098	1428	630	2000	Inox satinado	7035+7016
GARAGE099	1428	630	2000	Acero engomado	7035+7016

Compuesto por:

cant.	descripción
1	Armario con 7 cajones 1x75 4x100 2x150
1	Armario con 5 cajones 1x75 2x150 2x200
2	Kit 4 pies regulables
1	Top de acero inox satinado L=1428 mm
1	Kit tornillos de fijación
1	Montante central
1	Par de montantes
2	Panel perforado/repisa con borde bloquea caja
2	Panel perforado/repisa con borde bloquea caja



ART.	A mm	P mm	H mm	Top	RAL
GARAGE106	5515	630	2000	Inox satinado	7035+7016
GARAGE107	5515	630	2000	Acero engomado	7035+7016

Compuesto por:

cant.	descripción	cant.	descripción
2	Armario de puertas batientes ranuradas	2	Top de acero inox satinado L=1734 mm
4	Kit de 2 cubas estancas internas colectoras de líquidos capacidad 9 L	2	Kit tornillos de fijación
3	Par de tiras de relleno para armario	2	Par de montantes
2	Armario con 6 cajones 1x75 2x100 2x150 1x200	2	Montante central
2	Armario con 5 cajones 2x75 1x100 1x150 1x200	2	Panel perforado electric
2	Kit taponamiento para armario con ruedas	2	Toma múltiple Schuko de 4 compartimentos
2	Asa de tubo	2	Toma múltiple Schuko de 2 compartimentos
2	Kit de ruedas de goma antihuella sintética Ø 125 mm	2	Cable de conexión Wieland Schuko/FR
2	Pata reversible	2	Panel perforado/repisa con borde bloquea caja
1	Armario de puertas batientes	2	Panel perforado/repisa con borde bloquea caja
1	Kit de 4 estantes ranurados	2	Unidad de pared de apertura basculante sin cerradura
2	Kit 4 pies regulables	2	Unidad de pared de apertura basculante sin cerradura



ART.	A mm	P mm	H mm	Top	RAL	
GARAGE100	2041	630	2000	Inox satinado	7035+7016	
GARAGE101	2041	630	2000	Acero engomado	7035+7016	

Compuesto por:

cant.	descripción
1	Armario con 7 cajones 1x75 4x100 2x150
1	Armario con 5 cajones 1x75 2x150 2x200
2	Kit 4 pies regulables
3	Travesaño
1	Toma múltiple Schuko de 4 compartimentos
1	Cable de conexión Wieland Schuko/FR
1	Top de acero inox satinado L=2040 mm
1	Kit tornillos de fijación
1	Montante central
1	Par de montantes
2	Panel perforado/repisa con borde bloquea caja
2	Panel perforado/repisa con borde bloquea caja



ART.	A mm	P mm	H mm	Top	RAL	
GARAGE102	2041	630	2000	Inox satinado	7035+7016	
GARAGE103	2041	630	2000	Acero engomado	7035+7016	

Compuesto por:

cant.	descripción
1	Armario de puerta batiente
1	Armario con 5 cajones 2x75 1x100 1x150 1x200
1	Asa de tubo
1	Kit de ruedas de goma antihuella sintética Ø 125 mm
1	Kit taponamiento para armario con ruedas
1	Armario con 6 cajones 1x75 2x100 2x150 1x200
2	Kit 4 pies regulables
1	Top de acero inox satinado L=2040 mm
1	Kit tornillos de fijación
1	Par de montantes
1	Montante central
2	Panel perforado/repisa con borde bloquea caja
2	Panel perforado/repisa con borde bloquea caja



ART.	A mm	P mm	H mm	Top	RAL
GARAGE110	5712	630	2000	Inox satinado	7035+7016
GARAGE111	5712	630	2000	Acero engomado	7035+7016

Compuesto por:

cant.	descripción
2	Armarios con puertas correderas
2	Estante ranurado
2	Armario con 6 cajones 1x75 2x100 2x150 1x200
1	Armario con compartimiento de residuos con puerta batiente
1	Escotilla para residuos
1	Porta rollo con papel
1	Pata reversible
1	Toma múltiple Schuko de 4 compartimentos
1	Cable de conexión Wieland Schuko/FR
1	Armario con 5 cajones 2x75 1x100 1x150 1x200

cant.	descripción
1	Kit taponamiento para armario con ruedas
1	Asa de tubo
1	Kit de ruedas de goma antihuella sintética Ø 125 mm
5	Kit 4 pies regulables
4	Top de acero inox satinado L=1428 mm
4	Kit tornillos de fijación
4	Montante central
4	Par de montantes
8	Panel perforado/repisa con borde bloquea caja
4	Unidad de pared de apertura basculante sin cerradura

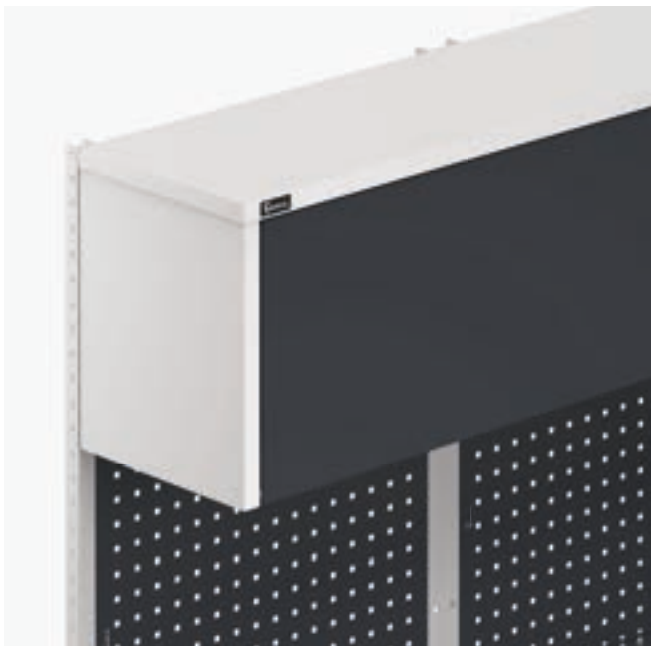



ART.	A mm	P mm	H mm	Top	RAL
GARAGE108	5508	630	2000	Inox satinado	7035+7016
GARAGE109	5508	630	2000	Acero engomado	7035+7016

Compuesto por:

cant.	descripción	cant.	descripción
2	Armario con 6 cajones 1x75 2x100 2x150 1x200	2	Top de acero inox satinado L=1734 mm
1	Armario con 5 cajones 2x75 1x100 1x150 1x200	2	Kit tornillos de fijación
1	Kit taponamiento para armario con ruedas	3	Par de montantes
1	Asa de tubo	2	Montante central
1	Kit de ruedas de goma antihuella sintética Ø 125 mm	2	Panel perforado electric
1	Pata reversible	2	Toma múltiple Schuko de 4 compartimentos
1	Armarios con puertas correderas	2	Toma múltiple Schuko de 2 compartimentos
2	Kit de 4 estantes ranurados	2	Cable de conexión Wieland Schuko/FR
1	Armario con compartimiento de residuos con puerta batiente	2	Panel perforado/repisa con borde bloquea caja
1	Escotilla para residuos	2	Panel perforado/repisa con borde bloquea caja
1	Porta rollo con papel	2	Unidad de pared de apertura basculante sin cerradura
5	Kit 4 pies regulables	2	Unidad de pared de apertura basculante sin cerradura



ART.	A mm	P mm	H mm	Top	RAL	
GARAGE112	744	744	2000	Inox satinado	7035+7016	
GARAGE113	744	744	2000	Acero engomado	7035+7016	

Compuesto por:

cant.	descripción
1	Pata de ángulo
1	Kit 4 pies regulables
1	Top de acero inox satinado para ángulo L=714 mm
2	Par de montantes
2	Panel perforado/repisa con borde bloquea caja
1	Colgante abatible



ART.	A mm	P mm	H mm	Top	RAL	
GARAGE114	744	714	2000	Inox satinado	7035+7016	
GARAGE115	744	714	2000	Acero engomado	7035+7016	

Compuesto por:

cant.	descripción
1	Pata de ángulo
1	Kit 4 pies regulables
1	Top de acero inox satinado para ángulo L=714 mm
1	Par de montantes
1	Panel perforado/repisa con borde bloquea caja
1	Unidad de pared de apertura basculante sin cerradura



ART.	A mm	P mm	H mm	RAL	
GARAGE116	583	600	921	7035+7016	

Compuesto por:

cant.	descripción
1	Armario con 5 cajones 2x75 1x100 1x150 1x200
1	Asa de tubo
1	Kit de ruedas de goma antihuella sintética Ø 125 mm
1	Kit taponamiento para armario con ruedas



ART.	A mm	P mm	H mm	Top	RAL	
GARAGE001	714	630	2000	Inox satinado	7035+7016	
GARAGE002	714	630	2000	Acero engomado	7035+7016	

Compuesto por:

cant.	descripción
1	Armario con 6 cajones 1x75 2x100 2x150 1x200
1	Kit 4 pies regulables
1	Top de acero inox satinado L=714 mm
1	Kit tornillos de fijación
1	Par de montantes
1	Panel perforado/repisa con borde bloquea caja
1	Unidad de pared de apertura basculante sin cerradura



ART.	A mm	P mm	H mm	Top	RAL	
GARAGE003	714	630	2000	Inox satinado	7035+7016	
GARAGE004	714	630	2000	Acero engomado	7035+7016	

Compuesto por:

cant.	descripción
1	Armario de puerta batiente
1	Estante regulable con soportes
1	Kit 4 pies regulables
1	Top de acero inox satinado L=714 mm
1	Kit tornillos de fijación
1	Par de montantes
1	Panel perforado/repisa con borde bloquea caja
1	Unidad de pared de apertura basculante sin cerradura



ART.	A mm	P mm	H mm	Top	RAL	
GARAGE005	714	630	2000	Inox satinado	7035+7016	
GARAGE006	714	630	2000	Acero engomado	7035+7016	

Compuesto por:

cant.	descripción
1	Armario técnico con puerta batiente
1	Toma múltiple Schuko de 4 compartimentos
1	Cable de conexión Wieland Schuko/FR
1	Kit 4 pies regulables
1	Top de acero inox satinado L=714 mm
1	Kit tornillos de fijación
1	Par de montantes
1	Panel perforado/repisa con borde bloquea caja
1	Unidad de pared de apertura basculante sin cerradura



ART.	A mm	P mm	H mm	RAL
GARAGE007	714	630	2000	7035+7016

Compuesto por:

cant.	descripción
1	Armario de puerta batiente
1	Kit 4 pies regulables
1	Top de acero inox satinado para lavabo L=714 mm
1	Kit tornillos de fijación
1	Lavabo
1	Mezclador
1	Par de montantes
1	Panel perforado/repisa con borde bloquea caja
1	Unidad de pared de apertura basculante sin cerradura



ART.	A mm	P mm	H mm	Top	RAL
GARAGE008	714	630	2000	Inox satinado	7035+7016

GARAGE009	714	630	2000	Acero engomado	7035+7016
------------------	-----	-----	------	----------------	-----------

Compuesto por:

cant.	descripción
1	Armario con compartimiento de residuos con puerta batiente
2	Escotilla para residuos
1	Kit 4 pies regulables
1	Top de acero inox satinado L=714 mm
1	Kit tornillos de fijación
1	Par de montantes
1	Panel perforado/repisa con borde bloquea caja
1	Unidad de pared de apertura basculante sin cerradura



ART.	A mm	P mm	H mm	Top	RAL
GARAGE010	714	630	2000	Inox satinado	7035+7016

GARAGE011	714	630	2000	Acero engomado	7035+7016
------------------	-----	-----	------	----------------	-----------

Compuesto por:

cant.	descripción
1	Armario con compartimiento de residuos con puerta batiente
1	Escotilla para residuos
1	Porta rollo con papel
1	Kit 4 pies regulables
1	Top de acero inox satinado L=714 mm
1	Kit tornillos de fijación
1	Par de montantes
1	Panel perforado/repisa con borde bloquea caja
1	Unidad de pared de apertura basculante sin cerradura



ART.	A mm	P mm	H mm	Top	RAL	
GARAGE012	1020	630	2000	Inox satinado	7035+7016	
GARAGE013	1020	630	2000	Acero engomado	7035+7016	

Compuesto por:

cant.	descripción
1	Armario con 6 cajones 1x75 2x100 2x150 1x200
1	Kit 4 pies regulables
1	Top de acero inox satinado L=1020 mm
1	Kit tornillos de fijación
1	Par de montantes
1	Panel perforado/repisa con borde bloquea caja
1	Unidad de pared de apertura basculante sin cerradura



ART.	A mm	P mm	H mm	Top	RAL	
GARAGE014	1020	630	2000	Inox satinado	7035+7016	
GARAGE015	1020	630	2000	Acero engomado	7035+7016	

Compuesto por:

cant.	descripción
1	Armario con 5 cajones 1x75 2x150 2x200
1	Kit 4 pies regulables
1	Top de acero inox satinado L=1020 mm
1	Kit tornillos de fijación
1	Par de montantes
1	Panel perforado/repisa con borde bloquea caja
1	Unidad de pared de apertura basculante sin cerradura



ART.	A mm	P mm	H mm	Top	RAL	
GARAGE016	1020	630	2000	Inox satinado	7035+7016	
GARAGE017	1020	630	2000	Acero engomado	7035+7016	

Compuesto por:

cant.	descripción
1	Armario de puertas batientes
1	Estante regulable con soportes
1	Kit 4 pies regulables
1	Top de acero inox satinado L=1020 mm
1	Kit tornillos de fijación
1	Par de montantes
1	Panel perforado/repisa con borde bloquea caja
1	Unidad de pared de apertura basculante sin cerradura



ART.	A mm	P mm	H mm	Top	RAL	
GARAGE018	1020	630	2000	Inox satinado	7035+7016	
GARAGE019	1020	630	2000	Acero engomado	7035+7016	

Compuesto por:

cant.	descripción
1	Armarios con puertas correderas
1	Estante ranurado
1	Kit 4 pies regulables
1	Top de acero inox satinado L=1020 mm
1	Kit tornillos de fijación
1	Par de montantes
1	Panel perforado/repisa con borde bloquea caja
1	Unidad de pared de apertura basculante sin cerradura



ART.	A mm	P mm	H mm	Top	RAL	
GARAGE020	1020	630	2000	Inox satinado	7035+7016	
GARAGE021	1020	630	2000	Acero engomado	7035+7016	

Compuesto por:

cant.	descripción
1	Armario con puertas correderas ranuradas
1	Kit de 2 cubas estancias internas colectoras de líquidos capacidad 19 L
1	Kit 4 pies regulables
1	Top de acero inox satinado L=1020 mm
1	Kit tornillos de fijación
1	Par de montantes
1	Panel perforado/repisa con borde bloquea caja
1	Unidad de pared de apertura basculante sin cerradura



ART.	A mm	P mm	H mm	Top	RAL	
GARAGE022	1020	630	2000	Inox satinado	7035+7016	
GARAGE023	1020	630	2000	Acero engomado	7035+7016	

Compuesto por:

cant.	descripción
1	Armario con puertas correderas ranuradas de policarbonato
1	Estante ranurado
1	Kit 4 pies regulables
1	Top de acero inox satinado L=1020 mm
1	Kit tornillos de fijación
1	Par de montantes
1	Panel perforado/repisa con borde bloquea caja
1	Unidad de pared de apertura basculante sin cerradura



ART.	A mm	P mm	H mm	Top	RAL
GARAGE024	1428	630	2000	Inox satinado	7035+7016
GARAGE025	1428	630	2000	Acero engomado	7035+7016

Compuesto por:

cant.	descripción
1	Armario con 6 cajones 1x75 2x100 2x150 1x200
1	Armario de puerta batiente
1	Estante regulable con soportes
2	Kit 4 pies regulables
1	Top de acero inox satinado L=1428 mm
1	Kit tornillos de fijación
1	Par de montantes
1	Montante central
2	Panel perforado/repisa con borde bloquea caja
1	Unidad de pared de apertura basculante sin cerradura



ART.	A mm	P mm	H mm	Top	RAL
GARAGE026	1428	630	2000	Inox satinado	7035+7016
GARAGE027	1428	630	2000	Acero engomado	7035+7016

Compuesto por:

cant.	descripción
1	Armario con 6 cajones 1x75 2x100 2x150 1x200
1	Kit 4 pies regulables
1	Armario con 5 cajones 2x75 1x100 1x150 1x200
1	Kit taponamiento para armario con ruedas
1	Asa de tubo
1	Kit de ruedas de goma antihuella sintética Ø 125 mm
1	Pata reversible
1	Top de acero inox satinado L=1428 mm
1	Kit tornillos de fijación
1	Montante central
1	Par de montantes
2	Panel perforado/repisa con borde bloquea caja
1	Unidad de pared de apertura basculante sin cerradura



ART.	A mm	P mm	H mm	Top	RAL	
GARAGE028	1428	630	2000	Inox satinado	7035+7016	
GARAGE029	1428	630	2000	Acero engomado	7035+7016	

Compuesto por:

cant.	descripción
1	Armario con 6 cajones 1x75 2x100 2x150 1x200
1	Armario con compartimiento de residuos con puerta batiente
1	Escotilla para residuos
1	Porta rollo con papel
2	Kit 4 pies regulables
1	Top de acero inox satinado L=1428 mm
1	Kit tornillos de fijación
1	Par de montantes
1	Montante central
2	Panel perforado/repisa con borde bloquea caja
1	Unidad de pared de apertura basculante sin cerradura



ART.	A mm	P mm	H mm	Top	RAL	
GARAGE030	1428	630	2000	Inox satinado	7035+7016	
GARAGE031	1428	630	2000	Acero engomado	7035+7016	

Compuesto por:

cant.	descripción
1	Armarios con puertas correderas
1	Estante ranurado
1	Kit 4 pies regulables
1	Top de acero inox satinado L=1428 mm
1	Kit tornillos de fijación
1	Par de montantes
1	Montante central
2	Panel perforado/repisa con borde bloquea caja
1	Unidad de pared de apertura basculante sin cerradura





ART.	A mm	P mm	H mm	Top	RAL	
GARAGE032	1428	630	2000	Inox satinado	7035+7016	
GARAGE033	1428	630	2000	Acero engomado	7035+7016	

Compuesto por:

cant.	descripción
1	Armario con puertas correderas ranuradas de policarbonato
1	Estante ranurado
1	Kit 4 pies regulables
1	Top de acero inox satinado L=1428 mm
1	Kit tornillos de fijación
1	Par de montantes
1	Montante central
2	Panel perforado/repisa con borde bloquea caja
1	Unidad de pared de apertura basculante sin cerradura



ART.	A mm	P mm	H mm	Top	RAL	
GARAGE034	1428	630	2000	Inox satinado	7035+7016	
GARAGE035	1428	630	2000	Acero engomado	7035+7016	

Compuesto por:

cant.	descripción
1	Armario con 6 cajones 1x75 2x100 2x150 1x200
1	Armario técnico con puerta batiente
1	Toma múltiple Schuko de 4 compartimentos
1	Cable de conexión Wieland Schuko/FR
2	Kit 4 pies regulables
1	Top de acero inox satinado L=1428 mm
1	Kit tornillos de fijación
1	Par de montantes
1	Montante central
2	Panel perforado/repisa con borde bloquea caja
1	Unidad de pared de apertura basculante sin cerradura



ART.	A mm	P mm	H mm	Top	RAL	
GARAGE036	1734	630	2000	Inox satinado	7035+7016	
GARAGE037	1734	630	2000	Acero engomado	7035+7016	

Compuesto por:

cant.	descripción
1	Armario con 6 cajones 1x75 2x100 2x150 1x200
1	Kit 4 pies regulables
1	Armario con 5 cajones 2x75 1x100 1x150 1x200
1	Kit taponamiento para armario con ruedas
1	Asa de tubo
1	Kit de ruedas de goma antihuella sintética Ø 125 mm
1	Pata reversible
1	Top de acero inox satinado L=1734 mm
1	Kit tornillos de fijación
1	Par de montantes
1	Montante central
1	Panel perforado/repisa con borde bloquea caja
1	Panel perforado/repisa con borde bloquea caja
1	Unidad de pared de apertura basculante sin cerradura
1	Unidad de pared de apertura basculante sin cerradura



ART.	A mm	P mm	H mm	Top	RAL	
GARAGE038	1734	630	2000	Inox satinado	7035+7016	

Compuesto por:

cant.	descripción
1	Armario de puertas batientes
1	Estante regulable con soportes
1	Armario con compartimiento de residuos con puerta batiente
2	Escotilla para residuos
2	Kit 4 pies regulables
1	Top de acero inox satinado L=1020 mm
1	Top de acero inox satinado para lavabo L=714 mm
2	Kit tornillos de fijación
1	Lavabo
1	Mezclador
1	Par de montantes
1	Montante central
1	Panel perforado/repisa con borde bloquea caja
1	Panel perforado/repisa con borde bloquea caja
1	Unidad de pared de apertura basculante sin cerradura
1	Unidad de pared de apertura basculante sin cerradura





ART.	A mm	P mm	H mm	Top	RAL
GARAGE039	1734	630	2000	Inox satinado	7035+7016
GARAGE040	1734	630	2000	Acero engomado	7035+7016

Compuesto por:

cant.	descripción
1	Armario con 6 cajones 1x75 2x100 2x150 1x200
1	Armario con compartimento de residuos con puerta batiente
1	Escotilla para residuos
1	Porta rollo con papel
2	Kit 4 pies regulables
1	Top de acero inox satinado L=1734 mm
1	Kit tornillos de fijación
1	Par de montantes
1	Montante central
1	Panel perforado/repisa con borde bloquea caja
1	Panel perforado/repisa con borde bloquea caja
1	Unidad de pared de apertura basculante sin cerradura
1	Unidad de pared de apertura basculante sin cerradura



ART.	A mm	P mm	H mm	Top	RAL
GARAGE041	1734	630	2000	Inox satinado	7035+7016
GARAGE042	1734	630	2000	Acero engomado	7035+7016

Compuesto por:

cant.	descripción
1	Armarios con puertas correderas
1	Estante ranurado
1	Armario con 6 cajones 1x75 2x100 2x150 1x200
2	Kit 4 pies regulables
1	Top de acero inox satinado L=1734 mm
1	Kit tornillos de fijación
1	Par de montantes
1	Montante central
1	Panel perforado/repisa con borde bloquea caja
1	Panel perforado/repisa con borde bloquea caja
1	Unidad de pared de apertura basculante sin cerradura
1	Unidad de pared de apertura basculante sin cerradura



ART.	A mm	P mm	H mm	Top	RAL	
GARAGE043	1734	630	2000	Inox satinado	7035+7016	
GARAGE044	1734	630	2000	Acero engomado	7035+7016	

Compuesto por:

cant.	descripción
1	Armario con puertas correderas ranuradas de policarbonato
1	Estante ranurado
1	Armario con 6 cajones 1x75 2x100 2x150 1x200
2	Kit 4 pies regulables
1	Top de acero inox satinado L=1734 mm
1	Kit tornillos de fijación
1	Par de montantes
1	Montante central
1	Panel perforado/repisa con borde bloquea caja
1	Panel perforado/repisa con borde bloquea caja
1	Unidad de pared de apertura basculante sin cerradura
1	Unidad de pared de apertura basculante sin cerradura



ART.	A mm	P mm	H mm	Top	RAL	
GARAGE045	1734	630	2000	Inox satinado	7035+7016	
GARAGE046	1734	630	2000	Acero engomado	7035+7016	

Compuesto por:

cant.	descripción
1	Armario con 6 cajones 1x75 2x100 2x150 1x200
1	Armario técnico con puerta batiente
1	Toma múltiple Schuko de 4 compartimentos
1	Cable de conexión Wieland Schuko/FR
2	Kit 4 pies regulables
1	Top de acero inox satinado L=1734 mm
1	Kit tornillos de fijación
1	Par de montantes
1	Montante central
1	Panel perforado/repisa con borde bloquea caja
1	Panel perforado/repisa con borde bloquea caja
1	Unidad de pared de apertura basculante sin cerradura
1	Unidad de pared de apertura basculante sin cerradura



ART.	A mm	P mm	H mm	Top	RAL
GARAGE047	2040	630	2000	Inox satinado	7035+7016
GARAGE048	2040	630	2000	Acero engomado	7035+7016

Compuesto por:

cant.	descripción
1	Armario con 6 cajones 1x75 2x100 2x150 1x200
1	Armario de puertas batientes
1	Estante regulable con soportes
2	Kit 4 pies regulables
1	Top de acero inox satinado L=2040 mm
1	Kit tornillos de fijación
1	Par de montantes
1	Montante central
2	Panel perforado/repisa con borde bloquea caja
2	Unidad de pared de apertura basculante sin cerradura



ART.	A mm	P mm	H mm	Top	RAL
GARAGE049	2040	630	2000	Inox satinado	7035+7016
GARAGE050	2040	630	2000	Acero engomado	7035+7016

Compuesto por:

cant.	descripción
1	Armario con 6 cajones 1x75 2x100 2x150 1x200
1	Armario con 5 cajones 2x75 1x100 1x150 1x200
1	Asa de tubo
1	Kit de ruedas de goma antihuella sintética Ø 125 mm
1	Kit taponamiento para armario con ruedas
1	Armario con compartimento de residuos con puerta batiente
1	Porta rollo con papel
1	Escotilla para residuos
2	Kit 4 pies regulables
1	Top de acero inox satinado L=2040 mm
1	Kit tornillos de fijación
1	Par de montantes
1	Montante central
2	Panel perforado/repisa con borde bloquea caja
2	Unidad de pared de apertura basculante sin cerradura



ART.	A mm	P mm	H mm	Top	RAL	
GARAGE051	2040	630	2000	Inox satinado	7035+7016	
GARAGE052	2040	630	2000	Acero engomado	7035+7016	

Compuesto por:

cant.	descripción
1	Armario con 6 cajones 1x75 2x100 2x150 1x200
1	Armarios con puertas correderas
1	Estante ranurado
2	Kit 4 pies regulables
1	Top de acero inox satinado L=2040 mm
1	Kit tornillos de fijación
1	Par de montantes
1	Montante central
2	Panel perforado/repisa con borde bloquea caja
2	Unidad de pared de apertura basculante sin cerradura



ART.	A mm	P mm	H mm	Top	RAL	
GARAGE053	2040	630	2000	Inox satinado	7035+7016	
GARAGE054	2040	630	2000	Acero engomado	7035+7016	

Compuesto por:

cant.	descripción
1	Armarios con puertas correderas
2	Estante ranurado
2	Kit 4 pies regulables
1	Top de acero inox satinado L=2040 mm
1	Kit tornillos de fijación
1	Par de montantes
1	Montante central
2	Panel perforado/repisa con borde bloquea caja
2	Unidad de pared de apertura basculante sin cerradura



ART.	A mm	P mm	H mm	Top	RAL
GARAGE055	2040	630	2000	Inox satinado	7035+7016
GARAGE056	2040	630	2000	Acero engomado	7035+7016

Compuesto por:

cant.	descripción
1	Armario con puertas correderas ranuradas de policarbonato
2	Estante ranurado
2	Kit 4 pies regulables
1	Top de acero inox satinado L=2040 mm
1	Kit tornillos de fijación
1	Par de montantes
1	Montante central
2	Panel perforado/repisa con borde bloquea caja
2	Unidad de pared de apertura basculante sin cerradura



ART.	A mm	P mm	H mm	Top	RAL
GARAGE057	2040	630	2000	Inox satinado	7035+7016
GARAGE058	2040	630	2000	Acero engomado	7035+7016

Compuesto por:

cant.	descripción
1	Armario con 6 cajones 1x75 2x100 2x150 1x200
1	Armario con puertas correderas ranuradas de policarbonato
1	Kit de 2 estantes/paneles perforados
1	Canaleta eléctrica para tomas múltiples
1	Toma múltiple Schuko de 2 compartimentos
1	Toma múltiple Schuko de 4 compartimentos
1	Cable de conexión Wieland Schuko/FR
2	Kit 4 pies regulables
1	Top de acero inox satinado L=2040 mm
1	Kit tornillos de fijación
1	Par de montantes
1	Montante central
2	Panel perforado/repisa con borde bloquea caja
2	Unidad de pared de apertura basculante sin cerradura



ART.	A mm	P mm	H mm	Top	RAL
GARAGE059	2040	630	2000	Inox satinado	7035+7016
GARAGE060	2040	630	2000	Acero engomado	7035+7016

Compuesto por:

cant.	descripción
2	Pata reversible
3	Travesaño
2	Toma múltiple Schuko de 4 compartimentos
2	Cable de conexión Wieland Schuko/FR
1	Top de acero inox satinado L=2040 mm
1	Kit tornillos de fijación
1	Par de montantes
1	Montante central
2	Panel perforado/repisa con borde bloquea caja
2	Unidad de pared de apertura basculante sin cerradura



ART.	A mm	P mm	H mm	Top	RAL
GARAGE061	2040	630	2000	Inox satinado	7035+7016
GARAGE062	2040	630	2000	Acero engomado	7035+7016

Compuesto por:

cant.	descripción
1	Pata reversible
3	Travesaño
2	Toma múltiple Schuko de 4 compartimentos
2	Cable de conexión Wieland Schuko/FR
1	Armario con 6 cajones 1x75 2x100 2x150 1x200
1	Kit 4 pies regulables
1	Top de acero inox satinado L=2040 mm
1	Kit tornillos de fijación
1	Par de montantes
1	Montante central
2	Panel perforado/repisa con borde bloquea caja
2	Unidad de pared de apertura basculante sin cerradura



ART.	A mm	P mm	H mm	Top	RAL
GARAGE063	2040	630	2000	Inox satinado	7035+7016
GARAGE064	2040	630	2000	Acero engomado	7035+7016

Compuesto por:

cant.	descripción
2	Armario con 6 cajones 1x75 2x100 2x150 1x200
2	Kit 4 pies regulables
3	Travesaño
1	Toma múltiple Schuko de 4 compartimentos
1	Cable de conexión Wieland Schuko/FR
1	Top de acero inox satinado L=2040 mm
1	Kit tornillos de fijación
1	Par de montantes
1	Montante central
2	Panel perforado/repisa con borde bloquea caja
2	Unidad de pared de apertura basculante sin cerradura



Courtesy of Trident Motorsport



Armario de puertas batientes



Par de tiras de relleno para armario



ART.	A mm	P mm	H mm	RAL
GARAGE065	512	630	2000	7035+7016

Compuesto por:

cant.	descripción
1	Armario de puerta batiente
2	Kit de 2 estantes ranurados
1	Par de tiras de relleno para armario



ART.	A mm	P mm	H mm	RAL
GARAGE066	512	630	2000	7035+7016

Compuesto por:

cant.	descripción
1	Armario de puertas batientes ranuradas
2	Kit de 2 cubas estancas internas colectoras de líquidos capacidad 9 L
1	Par de tiras de relleno para armario



ver página 256



ART.	A mm	P mm	H mm	RAL
GARAGE067	512	630	2000	7035+7016

Compuesto por:

cant.	descripción
1	Armario de puerta batiente
2	Kit de 2 estantes ranurados
3	Cajón de extracción simple H=100 mm
1	Par de tiras de relleno para armario



Par de tiras de relleno para armario



ART.	A mm	P mm	H mm	RAL	
GARAGE068	1023	630	2000	7035+7016	

Compuesto por:

cant.	descripción
1	Armario de puertas batientes
1	Kit de 4 estantes ranurados
1	Par de tiras de relleno para armario



ART.	A mm	P mm	H mm	RAL	
GARAGE069	1023	630	2000	7035+7016	

Compuesto por:

cant.	descripción
1	Armario de puertas batientes
1	Kit de 4 estantes ranurados
3	Cajón de extracción simple H=100 mm
1	Par de tiras de relleno para armario



ART.	A mm	P mm	H mm	RAL	
GARAGE070	1023	630	2000	7035+7016	

Compuesto por:

cant.	descripción
1	Armario de puertas batientes
1	Kit de 3 estantes ranurados
1	Kit de 2 estantes ranurados con guías
1	Kit de 3 estantes ranurados con guías
5	Contenedor de polipropileno Picking Box tamaño 2
6	Contenedor de polipropileno Picking Box tamaño 4
20	Contenedor de polipropileno Picking Box tamaño 3A2
6	Contenedor de polipropileno Picking Box tamaño 4A2
1	Par de tiras de relleno para armario



Armario de puertas batientes



Par de tiras de relleno para armario



ART.	A mm	P mm	H mm	RAL	
GARAGE071	1023	630	2000	7035+7016	

Compuesto por:

cant.	descripción
1	Armario de puertas batientes
3	Cajón de extracción simple H=100 mm
2	Kit de 2 estantes/paneles perforados
1	Par de tiras de relleno para armario



ART.	A mm	P mm	H mm	RAL	
GARAGE072	1023	630	2000	7035+7016	

Compuesto por:

cant.	descripción
1	Armario de puertas batientes ranuradas de policarbonato
1	Kit de 4 estantes ranurados
1	Par de tiras de relleno para armario



ART.	A mm	P mm	H mm	RAL	
GARAGE073	1023	630	2000	7035+7016	

Compuesto por:

cant.	descripción
1	Armario de puertas batientes ranuradas
2	Kit de 2 estantes/paneles perforados
2	Canaleta eléctrica para tomas múltiples
2	Toma múltiple Schuko de 2 compartimentos
2	Toma múltiple Schuko de 4 compartimentos
1	Cable de conexión Wieland con clavijas in/out
1	Cable de conexión Wieland Schuko/FR
1	Par de tiras de relleno para armario





Par de montantes



ART.	A mm	P mm	H mm	RAL	
GARAGE074	1020	630	2000	7035+7016	

Compuesto por:

cant.	descripción
1	Armarios con puertas correderas
1	Kit de 4 estantes ranurados
1	Kit 4 pies regulables
1	Par de montantes



ART.	A mm	P mm	H mm	RAL	
GARAGE075	1020	630	2000	7035+7016	

Compuesto por:

cant.	descripción
1	Armario con puertas correderas ranuradas
1	Kit de 4 estantes ranurados
1	Kit 4 pies regulables
1	Par de montantes



ART.	A mm	P mm	H mm	RAL	
GARAGE076	1020	630	2000	7035+7016	

Compuesto por:

cant.	descripción
1	Armario con puertas correderas ranuradas de policarbonato
1	Kit de 4 estantes ranurados
1	Kit 4 pies regulables
1	Par de montantes



Armarios con puertas correderas



Par de montantes



ART.	A mm	P mm	H mm	RAL	
GARAGE077	1427	630	2000	7035+7016	

Compuesto por:

cant.	descripción
1	Armarios con puertas correderas
2	Kit de 2 estantes ranurados
1	Kit 4 pies regulables
1	Par de montantes



ART.	A mm	P mm	H mm	RAL	
GARAGE078	1427	630	2000	7035+7016	

Compuesto por:

cant.	descripción
1	Armario con puertas correderas ranuradas
2	Kit de 2 estantes ranurados
1	Kit 4 pies regulables
1	Par de montantes



ART.	A mm	P mm	H mm	RAL	
GARAGE079	1427	630	2000	7035+7016	

Compuesto por:

cant.	descripción
1	Armario con puertas correderas ranuradas de policarbonato
2	Kit de 2 estantes ranurados
1	Kit 4 pies regulables
1	Par de montantes





Par de montantes



ART.	A mm	P mm	H mm	RAL	
GARAGE080	2040	630	2000	7035+7016	

Compuesto por:

cant.	descripción
1	Armarios con puertas correderas
2	Kit de 4 estantes ranurados
2	Kit 4 pies regulables
1	Par de montantes



ART.	A mm	P mm	H mm	RAL	
GARAGE081	2040	630	2000	7035+7016	

Compuesto por:

cant.	descripción
1	Armario con puertas correderas ranuradas
1	Kit de 4 estantes ranurados
2	Kit de 2 cubas estancas internas colectoras de líquidos capacidad 19 L
2	Kit 4 pies regulables
1	Par de montantes



ART.	A mm	P mm	H mm	RAL	
GARAGE082	2040	630	2000	7035+7016	

Compuesto por:

cant.	descripción
1	Armario con puertas correderas ranuradas de policarbonato
2	Kit de 4 estantes ranurados
2	Kit 4 pies regulables
1	Par de montantes



Armarios con puertas correderas



Par de montantes



ART.	A mm	P mm	H mm	RAL	
GARAGE083	2040	630	2000	7035+7016	

Compuesto por:

cant.	descripción
1	Armario con puertas correderas ranuradas
2	Kit de 2 estantes/paneles perforados
2	Canaleta eléctrica para tomas múltiples
2	Toma múltiple Schuko de 4 compartimentos
2	Toma múltiple Schuko de 2 compartimentos
1	Cable de conexión Wieland con clavijas in/out
1	Cable de conexión Wieland Schuko/FR
1	Kit de 4 estantes ranurados
2	Kit 4 pies regulables
1	Par de montantes



ART.	A mm	P mm	H mm	RAL	
GARAGE084	2040	630	2000	7035+7016	

Compuesto por:

cant.	descripción
1	Armario con puertas correderas ranuradas
1	Estante-panel perforado
1	Kit de 3 estantes ranurados
1	Tabique divisor
1	Kit tubo percha
1	Kit de 4 estantes ranurados
2	Kit 4 pies regulables
1	Par de montantes



ART.	A mm	P mm	H mm	RAL	
GARAGE085	2040	630	2000	7035+7016	

Compuesto por:

cant.	descripción
1	Armarios con puertas correderas
4	Kit de 2 estantes/paneles perforados
2	Kit 4 pies regulables
1	Par de montantes





Enrollador eléctrico con toma Schuko

ART.	Longitud del cable (m)	Tipo de toma	Volt	Watt
MBR13S0V0V00100	20	Schuko	230	1600



Enrollador para aire comprimido

ART.	Longitud del cable (m)	Presión máx. Mpa	Ø mm
MBR13S0V0V00200	14	1,5	10



Rodillo para enrollador

ART.
MBR13S0V0V00339



Placa para enrollador

Para fijar a la parte posterior del armario

ART.
MBR13S0V0V00499

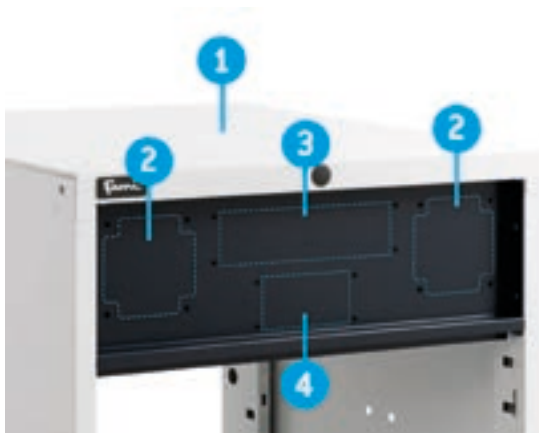

- 1. Armario técnico A=560 mm predispuesto para puerta
- 2. Módulo: Rodillo para enrollador

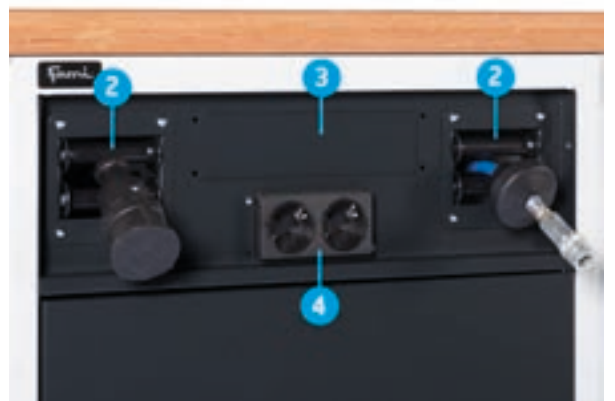

- 3. Módulo: Toma múltiple de 4 puestos
- 4. Módulo: Toma múltiple de 2 puestos

A= 717 MM

36X27 EH

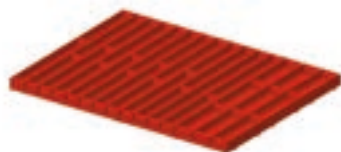

ART.	apto para cajón H mm	componentes	
FFH10051000	50/300	3 x Divisor de 3 canales 9 x Divisor de 4 canales 12 x Divisor transversal A=47 mm 36 x Divisor transversal A=36 mm	

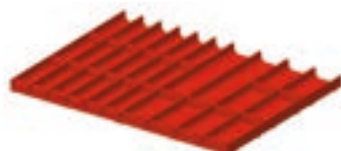

ART.	apto para cajón H mm	componentes	
FFH10051300	50/300	18 x Divisor transversal A=47 mm 12 x Divisor transversal A=73 mm 6 x Divisor de 2 canales 6 x Divisor de 3 canales	

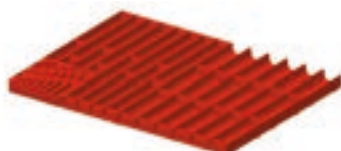

ART.	apto para cajón H mm	componentes	
FFH10051500	50/300	20 x Divisor transversal A=36 mm 20 x Divisor transversal A=47 mm 6 x Divisor de 3 canales 5 x Divisor de 4 canales 1 x Porta llaves Allen	

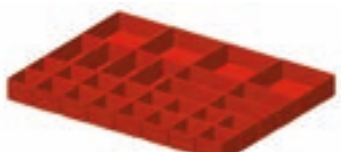

ART.	apto para cajón H mm	componentes	
FFH10071800	75	16 x Caja divisor 75x75 mm 8 x Caja divisor 150x75 mm 4 x Caja divisor 150x150 mm	

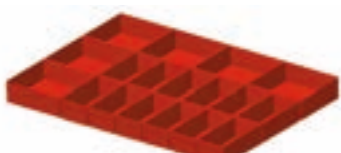

ART.	apto para cajón H mm	componentes	
FFH10071600	75	12 x Caja divisor 150x75 mm	
FFH10101600	100/125	6 x Caja divisor 150x150 mm	

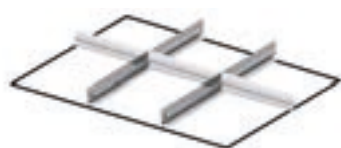

ART.	apto para cajón H mm	componentes	
FFH10070500	75		
FFH10100500	100/125	2 x Separador longitudinal ranurado A=457 mm	
FFH10150500	150/175	3 x Divisor transversal A=202 mm	
FFH10200500	200/250		



A= 1023 MM 54X27 EH



ART.	apto para cajón H mm	componentes	
FFH40051200	50/300	15 x Divisor transversal A=36 mm 10 x Divisor transversal A=47 mm 6 x Divisor transversal A=73 mm 6 x Divisor de 2 canales 6 x Divisor de 3 canales 6 x Divisor de 4 canales	



ART.	apto para cajón H mm	componentes	
FFH40051500	50/300	30 x Divisor transversal A=36 mm 10 x Divisor transversal A=47 mm 6 x Divisor de 3 canales 12 x Divisor de 4 canales	

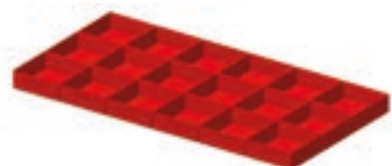

ART.	apto para cajón H mm	componentes	
FFH40071100	75	18 x Caja divisor 150x150 mm	
FFH40101100	100/125		



ART.	apto para cajón H mm	componentes	
FFH40071300	75	12 x Caja divisor 150x75 mm 12 x Caja divisor 150x150 mm	
FFH40101300	100/125		

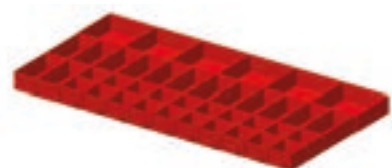

ART.	apto para cajón H mm	componentes	
FFH40071600	75	20 x Caja divisor 75x75 mm 14 x Caja divisor 150x75 mm 6 x Caja divisor 150x150 mm	

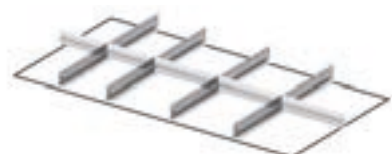

ART.	apto para cajón H mm	componentes	
FFH40070500	75	4 x Separador longitudinal ranurado A=457 mm 2 x Divisor transversal A=151 mm 3 x Divisor transversal A=202 mm	
FFH40100500	100/125		
FFH40150500	150/175		
FFH40200500	200/250		

THE
BLOCK

UNIPOK
MIX AND MATCH





Fanni



Fami





A series of horizontal lines for writing, starting with a pair of lines at the top and followed by single lines below.

CONDICIONES GENERALES DE LA GARANTÍA

Estimado cliente:

Cada producto que usted compra a Fami S.r.l. está acompañado de una garantía estándar (la «Garantía»), la cual se rige por las condiciones y los términos que se indican a continuación.

1. PREMISAS

1.1 En las Condiciones siguientes, los términos indicados a continuación tendrán el siguiente significado:

a) Vendedor: Fami S.r.l.;

b) Cliente: cualquier sujeto (persona física, sociedad, ente o entidad jurídica) que compra los Productos del Vendedor;

c) Producto/s: los bienes fabricados, ensamblados y/o comercializados por el Vendedor, excluidos los Productos de marca Store Van.

2. OBJETO DE LA GARANTÍA

2.1 Fami S.r.l. garantiza que los Productos carecen de vicios y responden a las especificaciones técnicas declaradas por el Vendedor.

2.2 Se entiende que las dimensiones de los Productos tienen en cuenta los márgenes de tolerancia de uso comercial en relación con el tipo, la cantidad y la calidad de los Productos. Por lo tanto, el Vendedor no garantiza que los Productos respondan a especificaciones particulares o a características técnicas o su idoneidad para usos específicos diferentes de los indicados en las especificaciones técnicas declaradas por Fami S.r.l. y previstas en el manual de uso y mantenimiento, a no ser en la medida en que estas características hayan sido acordadas expresamente en el contrato de venta.

2.3 Cuando el Cliente notifique y se constate la presencia de defectos en los Productos, el Cliente tendrá derecho a su reparación gratuita o bien, cuando la reparación sea imposible o excesivamente onerosa, a la sustitución gratuita del Producto, a juicio incuestionable del Vendedor, excluyéndose cualquier otra obligación a cargo de Fami S.r.l.

2.4 La Garantía no afecta, y por lo tanto se mantienen, los derechos previstos en el Decreto Legislativo n.º 206 de 6.9.2005 y posteriores enmiendas y complementos (el «Código del Consumidor»), en caso de que el Cliente pueda definirse como «consumidor».

3. CONDICIONES DE VALIDEZ DE LA GARANTÍA

3.1 Para la activación de la Garantía, el Cliente tendrá que comunicar a Fami, en los plazos a los que se refieren los artículos 4 y 5 siguientes, acerca de los defectos a través de una reclamación (la «Reclamación») con el contenido indicado en el art. 5 siguiente.

3.2 Una vez realizada la Reclamación, el Cliente deberá interrumpir de inmediato el uso del/los Producto/s defectuoso/s.

3.3 Después de recibir la Reclamación, el Vendedor procederá a la comprobación de la existencia, la naturaleza y la consistencia de los defectos y a comprobar la puntualidad de la Reclamación con arreglo al artículo 5 siguiente. Con tal finalidad, el Cliente deberá poner a disposición el/los Producto/s defectuoso/s para su inspección, incluso mediante el envío de documentación fotográfica o el uso de sistemas de videoconferencia. El Vendedor reparará el producto en su propio domicilio social, su filial o en uno de sus distribuidores autorizados. El Vendedor se reserva la facultad de reparar el Producto en las instalaciones del Cliente. Cuando sea necesario, el Cliente podrá enviar a su cargo el Producto defectuoso a uno de los mencionados lugares, conforme a lo indicado por el Vendedor, sin perjuicio de las normas del Código de Consumo. El Vendedor remitirá al Cliente el nuevo Producto o el Producto reparado, sosteniendo los gastos de envío.

3.4 La reparación de un Producto defectuoso se llevará a cabo en un plazo razonable respecto a la magnitud del defecto.

4. DURACIÓN – PERÍODO DE VALIDEZ

4.1 La duración de la Garantía para los Productos es de 10 años y empieza a contar a partir de la fecha de entrega de los Productos, a no ser que se trate de Productos comercializados, componentes eléctricos, software y las partes sometidas a desgaste, para los cuales se prevé una garantía de 12 meses, que también empieza a contar desde su fecha de entrega. Se aclara que por «fecha de entrega» se entiende la fecha en que los Productos han abandonado los almacenes de Fami S.r.l. para ser entregados al Cliente, sin perjuicio de cualquier otra disposición diferente en el contrato de venta.

4.2 En el caso de los Productos reparados o sustituidos, la garantía empieza a contar nuevamente y tiene una duración de 12 meses desde la reparación o desde la sustitución. Por lo tanto, en conjunto, la duración de la Garantía para Productos reparados o sustituidos por el Vendedor es de máximo 11 años o bien, para los Productos comercializados, componentes electrónicos, software y las partes sometidas a desgaste, de máximo 24 meses desde el inicio de la duración de la Garantía indicada en el artículo 4.1 anterior.

4.3 Al vencer el plazo indicado en el artículo 4.1 anterior, el derecho de recurso previsto en el art. 131 del Código del Consumidor, cuando sea aplicable, debe entenderse prescrito e inadmisibles.

5. PLAZOS Y MÉTODOS DE LA RECLAMACIÓN

5.1 Durante el periodo de vigencia de la Garantía, las posibles reclamaciones relativas al estado del embalaje, cantidad, número o características exteriores de los Productos (vicios y defectos no ocultos y visibles por fuera) deberán ser anotados por el Cliente en el albarán de entrega e indicando la anotación «reserva específica» al firmar el D.D.T. En el plazo máximo de 2 (dos) días laborables desde la fecha de recepción de los Productos, el Cliente deberá enviar al Vendedor, mediante mensaje de correo electrónico a la siguiente dirección assistance@famisp.it, una copia del albarán de entrega y las relativas fotografías, facilitando información detallada sobre las condiciones de los Productos y sobre la naturaleza de los defectos detectados.

5.2. Las posibles reclamaciones relativas a defectos no detectables mediante un control diligente en el momento de la recepción (vicios ocultos) deberán notificarse al Vendedor, so pena de prescripción, en el plazo máximo de 7 (siete) días desde la fecha en que se ha descubierto el defecto, mediante mensaje de correo electrónico certificado a la siguiente dirección pec@pec.famisp.it, especificando en detalle el código del producto, el lote (si está disponible), la fecha de entrega y la naturaleza del defecto.

6. EXCLUSIONES Y LIMITACIÓN DE LA RESPONSABILIDAD

6.1 La garantía no se aplica a los Productos cuyos defectos se deben a: a) operaciones de transporte; b) incumplimiento de las medidas que entran en la praxis ordinaria de mantenimiento; negligencia y descuido en el uso; c) incumplimiento de las instrucciones facilitadas por el Vendedor para el uso y/o el almacenamiento del Producto; d) incumplimiento de las normas de instalación y/o de cualquier otra indicación o instrucción presente en las notas técnicas que acompañan al Producto cuando la instalación no haya sido realizada directamente por el Vendedor; e) manipulaciones, mantenimiento en general, intervenciones realizadas por el Cliente o por personal no autorizado del Vendedor; f) uso anómalo y/o impropio del Producto, colocación de este en locales húmedos, excesivamente cálidos o fríos, polvorientos o agresivos (presencia de cloro, lacas, barnices u otros agentes químicos y/o tóxicos) o en cualquier caso en lugares inadecuados para la correcta conservación de los Productos en los límites en que estas circunstancias no hayan sido documentadas por el Vendedor antes de la compra de los Productos y el Vendedor haya garantizado la tolerancia de los Productos a estos ambientes; g) agravio de los daños causado por el uso de los Productos por parte del Cliente una vez que se hayan manifestado los defectos; h) uso de piezas de recambio, componentes y accesorios no originales o no aconsejados por el Vendedor (no puede solicitarse la sustitución o la reparación de piezas no originales) y daños provocados al Producto por el uso de estas; i) anomalías o funcionamiento defectuoso de la alimentación eléctrica;

l) corrosión, incrustaciones o roturas provocadas por corrientes parásitas, condensación, agresividad o acidez del agua, tratamientos desincrustantes realizados de manera incorrecta, depósitos de lodos o cal; m) caso fortuito, causas de fuerza mayor como, a título de ejemplo y no exhaustivo, hielo, recalentamiento, incendio, robo, desastres naturales (como por ejemplo granizo, tornados, rayos, inundaciones, terremotos), vandalismo, accidentes y otros sucesos similares.

6.2 La Garantía no es válida si el precio de venta de los Productos no ha sido pagado por completo, estableciendo que si el pago está previsto en plazos, la Garantía será inmediatamente válida y permanecerá válida mientras se respeten los vencimientos de los pagos.

6.3 El Vendedor declina toda responsabilidad por posibles daños que se puedan causar, directa o indirectamente, a personas, animales o cosas como consecuencia del incumplimiento de todas las instrucciones dadas en el manual de instalación, uso y mantenimiento.

6.4 El Vendedor declina toda responsabilidad por daños indirectos causados por los defectos de un Producto, como a título meramente enunciativo y no limitativo, la parada de producción o la falta de envío o cesión a terceros del Producto.

6.5 En cualquier caso, la responsabilidad del Vendedor no podrá superar el precio pagado por el Cliente por cada contrato de venta de cuyo contenido se ha derivado el hecho inherente a la posible solicitud de daño y/o resarcimiento.

6.6 Los Productos deberán utilizarse única y exclusivamente para los fines indicados y respetando las normativas de seguridad, conforme a las disposiciones del manual de instalación, uso y mantenimiento entregado por el Vendedor; en caso de que el Cliente utilice o revenda los Productos adquiridos y/o Productos del Vendedor para otros fines, lo hace por su cuenta y riesgo, con todas las consecuencias consiguientes. En ese caso, se descarta la responsabilidad contractual y/o extracontractual del Vendedor por posibles daños directos e indirectos sufridos también por terceros, así como en caso de mantenimiento incorrecto, uso inadecuado, incumplimiento de normas de seguridad y otras hipótesis, y el Cliente deberá mantener al Vendedor indemne de costes y/o responsabilidades que pudieran recaer sobre él.

7. TRIBUNAL COMPETENTE Y LEY APLICABLE

7.1 Para cualquier controversia derivada o asociada a las presentes Condiciones Generales de Garantía como, a mero título de ejemplo y no exhaustivo, controversias relativas a su existencia, validez, interpretación, eficacia, ejecución, será competente para decidir con carácter exclusivo el Tribunal de Vicenza, también cuando el Contrato presente elementos de internacionalidad, sin perjuicio de las normas inderogables del Código del Consumo.

7.2 Las presentes Condiciones Generales de Garantía se someten íntegramente a la ley italiana y se interpretan de conformidad con esta, también cuando el Contrato presente elementos de internacionalidad, excluyéndose expresamente la Convención de Viena de 1980.

CONDICIONES GENERALES DE VENTA

1. DEFINICIONES

1.1 En el contexto de las presentes Condiciones, los términos indicados a continuación tendrán el siguiente significado:

- a) Vendedor: Fami S.r.l.
- b) Comprador: cualquier sociedad ente o entidad jurídica que compra los Productos del Vendedor;
- c) Productos: los bienes fabricados, ensamblados y/o comercializados por el Vendedor;
- d) Pedido: cada propuesta de compra de los Productos remitida por el Comprador al Vendedor;
- e) Confirmación del Pedido: la aceptación escrita del Pedido por parte del Vendedor;
- f) Contrato: la venta celebrada entre el Vendedor y el Comprador tras la recepción por parte del Comprador de la Confirmación del Pedido;
- g) Partes: el Vendedor y el Comprador conjuntamente;
- h) Marcas: todas las marcas de las cuales el Vendedor es propietario o licenciatario;
- i) Derechos de Propiedad Intelectual: todos los derechos de propiedad intelectual y/o industrial de Fami S.r.l. incluidos, sin limitación alguna, los derechos relativos a: patentes de invención, diseños o modelos, modelos de utilidad, marcas, know-how, especificaciones técnicas, datos, software, con independencia de que estos derechos estén registrados o no, así como cualquier demanda o registro relativo a estos derechos y a cualquier otro derecho o forma de protección de naturaleza similar o con efecto equivalente.

2. DISPOSICIONES GENERALES

2.1 Las presentes Condiciones Generales de Venta (en lo sucesivo, las «Condiciones») forman parte integrante de los Contratos celebrados entre el Vendedor y el Comprador para el suministro de los Productos.

2.2 Las Condiciones se aplican entre Fami S.r.l. (en lo sucesivo, «Fami») y el Comprador sin necesidad de aludir expresamente a estas ni de realizar un recordatorio en este sentido. Cualquier condición o término diferente solo es de aplicación si el Vendedor lo/la confirma por escrito.

2.3 El Vendedor se reserva el derecho a modificar, complementar o eliminar cualquier disposición de las presentes Condiciones Generales de Venta, en cualquier momento, comunicándolo también mediante la página específica de la web empresarial, entendiéndose que estos añadidos, modificaciones o eliminaciones se aplicarán a todas las Ventas celebradas a partir del 15.º día posterior a la comunicación (mediante publicación en la web o mediante envío de boletín de noticias o de cualquier correspondencia enviada por escrito) al Comprador de las nuevas Condiciones de Venta.

2.4 Cualquier referencia a términos comerciales (como EXW, DPA, DPU, DDP, etc.) se entenderá como alusión a los Incoterms® de la Cámara de Comercio Internacional, en el texto vigente en la fecha de celebración del Contrato.

3. ÁMBITO DE APLICACIÓN

3.1 Las presentes Condiciones Generales de Venta (en lo sucesivo, las «Condiciones») se aplican a todos los Contratos (ya se celebren por teléfono, fax, correo electrónico o sitio web), cuando las partes no las hayan derogado expresamente por escrito, y forman parte integrante y sustancial de cada Pedido, Confirmación de Pedido, aunque no se citen expresamente.

3.2 El comprador no puede esgrimir ni alegar condiciones diferentes de las presentes Condiciones. Por lo tanto, carecen de validez las posibles condiciones indicadas por escrito por el Comprador en el Pedido, o en cualquier otra fase de la negociación contractual, así como tras la Confirmación del Pedido, así como las posibles condiciones generales de compra del propio Comprador. Cualquier condición escrita o verbal enviada por parte de colaboradores, empleados, agentes o representantes del Vendedor carece de valor si no se reproduce en el texto de la Confirmación del Pedido o si el Vendedor no la confirma por escrito. En este sentido la ejecución, también parcial, del Pedido por parte de Fami o cualquier otro cumplimiento suyo respecto al Comprador no equivalen ni pueden interpretarse como una aceptación tácita o implícita de cualquier condición general contractual que no haya sido suscrita expresamente por Fami.

3.3 Las Condiciones son válidas únicamente para relaciones contractuales entre Fami y operadores profesionales, por lo que no será de aplicación el D. Leg. n.º 206, de 6 de septiembre de 2005, (Código de Consumo) y las enmiendas posteriores.

4. OFERTAS Y PEDIDOS

4.1 Las ofertas del Vendedor no deben considerarse vinculantes. Las indicaciones presentes en catálogos, folletos y listas no comprometen al Vendedor, que se reserva la facultad de aportar cualquier modificación a los Productos y a sus precios; por lo tanto, el Vendedor se considera vinculado exclusivamente por lo indicado en la Confirmación del Pedido.

4.2 Cada Pedido enviado por el Comprador, tanto directamente a Fami como mediante los agentes o los representantes del Vendedor, debe entenderse como una propuesta irrevocable de compra, que será eficaz durante 30 (treinta) días, a partir de la fecha de su correcta recepción por parte del Vendedor, salvo derogación explícita indicada en cada caso.

4.3 El envío del Pedido por parte del Comprador implica la lectura íntegra y el conocimiento por su parte de todas las presentes Condiciones, las cuales deberán así considerarse íntegramente aceptadas por el Comprador sin limitaciones ni reservas.

4.4 El Comprador debe confirmar por escrito los Pedidos y/o las posibles modificaciones de los Pedidos efectuados verbal o telefónicamente. En caso contrario, el Vendedor declina toda responsabilidad respecto a posibles errores o posibles malentendidos.

4.5 El Vendedor se reserva expresamente el derecho a valorar cada Pedido, no estando obligado a su aceptación.

4.6 Los Pedidos correctamente aceptados por el Vendedor mediante Confirmación del Pedido no podrán ser cancelados por el Comprador sin la autorización escrita del Vendedor.

5. CELEBRACIÓN DEL CONTRATO

5.1 El Contrato solo podrá considerarse celebrado tras el envío de una Confirmación del Pedido por parte de Fami (por correo electrónico, fax u otros medios telemáticos equivalentes), en relación con cada Pedido. En cualquier caso, la emisión de la factura por parte del Vendedor o la ejecución del Pedido por parte del Vendedor se considerará una confirmación.

5.2 Cuando la Confirmación del Pedido contenga añadidos, limitaciones u otras variaciones respecto al Pedido, se entenderá que el Comprador acepta tácitamente estas variaciones siempre que no presente una reclamación escrita al Vendedor en el plazo de 2 días laborables desde su recepción.

5.3 Las modificaciones y los complementos solicitados por el Comprador tras la celebración del Contrato no tendrán valor ni eficacia si el Vendedor no los acepta por escrito, con la posible aclaración de los nuevos plazos de entrega, del precio y de las modalidades de pago.

5.4 Todos los Contratos se consideran siempre celebrados en el domicilio social de Fami S.r.l. en Italia, 36027 Rosà (VI), Via Stazione Rossano n.º 13.

6. PRECIOS

6.1. Los precios de los Productos serán los indicados en la lista de precios del Vendedor vigente en el momento de la formalización del Pedido o, si el Producto no está incluido en la lista de precios o la lista de precios no estuviera disponible, aquellos indicados en dicha Confirmación del Pedido.

6.2 Los precios de los Productos serán los indicados en la Confirmación del Pedido y, salvo acuerdo contrario, se entienden para mercancía entregada en fábrica (EXW). Estos precios, sin perjuicio de una indicación contraria en la Confirmación del Pedido, no incluyen los costes y los gastos de embalaje especiales, envío, seguro y transporte desde los locales del Vendedor, cualquier gasto, tasa o impuesto inherente a la venta de los Productos, incluidos los costes de todas las formalidades aduaneras (a título de ejemplo y no exhaustivo: aranceles, tasas y otros gastos para la exportación de los Productos), que corren a cargo del Comprador.

6.3 El Vendedor se reserva el derecho a ajustar el precio en caso de modificación (a) del Contrato, exigida por el Comprador después de su celebración y aceptación por el Vendedor y (b) del tipo de suministro, del material o de la ejecución de los Productos debido a la información y/o documentación facilitada por el Comprador incompleta o incorrecta.

7. CONDICIONES DE PAGO

7.1. En el momento de la celebración del contrato, el Vendedor podrá solicitar al Comprador el desembolso de un anticipo del 30 % del valor del suministro. En cualquier caso, las Partes pueden pactar el desembolso de un anticipo diferente previo acuerdo por escrito en el Contrato.

7.2 En caso de impago del anticipo, cuando esté previsto, el Contrato se considera resuelto ipso iure y el Vendedor podrá solicitar el pago de las cuantías devengadas hasta ese momento, además del resarcimiento de todos los daños patrimoniales y no patrimoniales, así como los gastos, también legales, que hubiera podido sostener.

7.3 Cuando en el Contrato no se detallan las condiciones de pago, este deberá efectuarse a 30 días de la fecha de factura a final de mes, mediante transferencia bancaria. El pago se considera realizado cuando la cuantía pasa a estar disponible en el Banco del Vendedor en Italia. Si las Partes han acordado el pago anticipado sin otras indicaciones, se supone que el pago anticipado se refiere al precio total de los Productos incluidos en el suministro. En caso de entrega fraccionada, el comprador deberá, para cada una de estas, desembolsar el importe correspondiente a la mercancía entregada, a no ser que se acuerde otra cosa por escrito en el Contrato.

7.4 Los pagos deben efectuarse en la divisa acordada y los posibles gastos o comisiones bancarias debidas en relación con el pago correrán íntegramente a cargo del Comprador.

7.5 En caso de impago o retraso en el pago, también parcial, por parte del Comprador, el Vendedor, sin perjuicio de sus otros derechos, estará facultado para suspender las entregas siguientes aunque se deban con motivo de otros contratos y solicitar el pago inmediato e íntegro de todo el material pedido, así como diferir sus entregas durante un plazo igual al retraso en los pagos, con independencia de su importe y esto hasta la liquidación de estos pagos y de los relativos intereses de demora.

7.6 El Vendedor tiene derecho al reconocimiento y al pago a su favor de los intereses de demora conforme al D. Leg. 231/2002 sobre los impagos y los pagos con retraso, además de los gastos, también legales, que pudieran ser necesarios para recuperar las cuantías que corresponden al Vendedor en cualquier concepto.

7.7 El impago aunque solo sea de una factura dará al Vendedor derecho a resolver cualquier Contrato existente con el Comprador con arreglo al 1456 c.c. y a suspender el envío o la entrega de cualquier otro suministro en curso de ejecución, en cualquier caso sin perjuicio del resarcimiento íntegro del daño ocasionado por el incumplimiento o el retraso del Comprador. Los posibles retrasos en el envío de los Pedidos o en las entregas ocasionados por suspensiones anteriores de la producción debido a impagos del Comprador no constituirán un incumplimiento del Vendedor.

7.8 Cualquier reclamación o queja no dará derecho al Comprador a suspender ni retrasar los pagos.

8. PLAZOS DE ENTREGA

8.1. El plazo de entrega será el indicado en la Confirmación del Pedido y, salvo acuerdo contrario, se entiende realizada en fábrica (EXW) en las instalaciones del Vendedor. Si se solicita y se acuerda expresamente por escrito en el Contrato, Fami se encargará del transporte de los Productos, por cuenta y riesgo y a expensas del Comprador. Los posibles gastos de transporte correrán a cargo del Comprador y esto no afectará de ninguna manera a los riesgos del envío que también permanecerán a cargo del Comprador como muy tarde con la entrega de los Productos al primer transportista.

8.2. Los Productos se entregarán dentro del plazo establecido en el Contrato, calculado en días laborables; sin embargo, cabe precisar que los plazos de entrega son solo indicativos y no son esenciales y, en cualquier caso, no incluyen el tiempo de transporte. Por lo tanto, el Vendedor no responderá por el retraso en la entrega por ningún motivo.

8.3. Cuando el Comprador solicite al Vendedor una variación del plazo de entrega, deberá formular dicha petición por escrito y proceder en cualquier caso a liquidar el suministro en los plazos indicados en el artículo 7 de las presentes Condiciones. Solo se excluyen los posibles costes de custodia, entrega, montaje, desmontaje e instalación, que deberán liquidarse en la nueva fecha de entrega acordada.

- 8.4. A partir de la recepción del aviso de puesta a disposición, el Comprador deberá retirar la mercancía en un plazo máximo de 10 (diez) días. En caso contrario, los Productos podrán almacenarse al aire libre, exonerando al Vendedor de cualquier responsabilidad y provocando la caducidad de todas las garantías y cargando en cuenta al Comprador los gastos de manipulación y almacenamiento sostenidos por el Vendedor, que también se reserva la facultad de almacenar los Productos en un depósito a cargo del Comprador.
- 8.5. En el plazo de 10 (diez) días desde el aviso de mercancía a disposición, el Vendedor estará facultado para emitir la factura correspondiente.
- 8.6. En caso de retraso en la recogida de la mercancía, en cualquier caso a disposición, por cualquier motivo ajeno a la voluntad del Vendedor, la entrega se considerará de todos modos realizada transcurridos diez días desde la comunicación del aviso de mercancía a disposición. En ese caso el Vendedor tendrá derecho a facturar y a reclamar el cumplimiento de las condiciones de pago acordadas y podrá encomendar el embalaje, el transporte o el almacenamiento de la mercancía con cargo al Comprador, sin perjuicio del resarcimiento de los posibles daños sufridos, también para el almacenamiento, la custodia y el depósito de la mercancía.
9. GARANTÍA Y RECLAMACIONES
- 9.1. La reglamentación de la Garantía ofrecida por el Vendedor consta en el documento Condiciones Generales de Garantía que puede consultarse en la web www.famisp.com y, en lo referente exclusivamente a los Productos de marca Store Van, en el documento Condiciones Generales de Garantía que puede consultarse en la web www.storevan.com.
- 9.2. Al recibir los Productos el comprador deberá examinarlos en presencia del transportista encargado de la entrega para comprobar la posible presencia de defectos visibles por fuera (a título de ejemplo y no exhaustivo, las cantidades y el embalaje de los Productos, la conformidad de los Productos respecto a lo indicado en la Confirmación del Pedido).
- 9.3. Las posibles reclamaciones relativas al estado del embalaje, cantidad, número o características exteriores de los Productos (vicios y efectos no ocultos y visibles por fuera) deberán ser anotados por el Comprador en el albarán de entrega e indicando la anotación «reserva específica» al firmar el D.D.T. En el plazo máximo de 2 (dos) días laborables desde la fecha de recepción de los Productos, el Comprador deberá enviar al Vendedor, mediante mensaje de correo electrónico a la siguiente dirección assistance@famisp.it, una copia del albarán de entrega y las relativas fotografías, facilitando información detallada sobre las condiciones de los Productos y sobre la naturaleza de los defectos detectados.
- 9.4. Sin perjuicio de la duración de la Garantía ofrecida por el Vendedor, las posibles reclamaciones relativas a defectos no detectables mediante un control diligente en el momento de la recepción (vicios ocultos) deberán notificarse al Vendedor, so pena de prescripción, en el plazo máximo de 7 (siete) días desde la fecha en que se ha descubierto el defecto, mediante mensaje de correo electrónico certificado a la siguiente dirección pec@pec.famisp.it, especificando en detalle el código del producto, el lote (si está disponible), la fecha de entrega y la naturaleza del defecto.
- 9.5. Cualquier Producto para el cual no se haya presentado ninguna reclamación conforme a los procedimientos y a los plazos anteriormente indicados, se considera aprobado y aceptado por el Cliente.
- 9.6. En ningún caso los agentes, clientes o intermediarios del Vendedor tendrán el poder de representar ni comprometer a esta última ante el Comprador u otros terceros. Con este fin, cualquier comunicación relativa a vicios y defectos de los Productos carecerá de validez y eficacia cuando se transmita a agentes, clientes o intermediarios del Vendedor, o bien en formas o modalidades diferentes de las arriba indicadas.
10. RESERVA DE PROPIEDAD
- 10.1. Los Productos siguen siendo de propiedad del Vendedor hasta la fecha en que el Comprador haya procedido al pago de su precio íntegro y de todas las cuantías debidas al Vendedor.
- 10.2. En caso de que en el país en el que tiene domicilio social el Comprador, para la validez de la reserva de propiedad a favor del Vendedor sea necesario realizar formalidades administrativas o legales como, sin limitación alguna, el inscripción de los Productos en registro públicos, o bien su precintado, el Comprador se compromete desde este momento a colaborar con el Vendedor y a acometer todos los actos necesarios a fin de que este disfrute de un derecho válido, también respecto a posibles terceros, en relación con la reserva de propiedad.
11. FUERZA MAYOR
- 11.1. Tanto el Comprador como Fami podrán suspender la ejecución de sus obligaciones contractuales cuando dicha ejecución sea imposible o irrazonablemente costosa por un impedimento imprevisible e independiente de sus voluntades, como a título de ejemplo no exhaustivo, huelgas, epidemia y/o pandemia, boicots, cierres patronales, incendios, guerras, disturbios y revoluciones, requisas, embargos y costes de energía.
- 11.2. La Parte que desee acogerse a esta cláusula deberá comunicar inmediatamente por escrito, mediante correo electrónico certificado, a la otra parte la ocurrencia y la conclusión de las circunstancias de fuerza mayor.
- 11.3. Cuando la suspensión debida a fuerza mayor dure más de ocho semanas, cada Parte tendrá derecho a resolver el Pedido, con un preaviso de 10 días, que se comunicará a la otra parte por escrito, mediante carta certificada con acuse de recibo o mediante comunicación mediante correo electrónico certificado.
- 11.4. En cualquier caso, se entiende que el Vendedor tendrá derecho a recibir el pago de los Productos que ya pudiera haber entregado, además del reembolso de posibles gastos ya sostenidos.
12. CAMBIO EN LAS CONDICIONES PATRIMONIALES DEL COMPRADOR
- 12.1. Fami tendrá derecho a suspender el cumplimiento de las obligaciones derivadas del suministro de los Productos si las condiciones patrimoniales del Comprador pusieran en grave peligro la posibilidad de recibir el pago, salvo que se otorgue una garantía adecuada. Se entiende que el Vendedor tendrá derecho a recibir el pago de los Productos que ya pudiera haber entregado, además del reembolso de posibles gastos ya sostenidos.
13. PROPIEDAD INTELECTUAL
- 13.1. Los Derechos de Propiedad Intelectual son de total y exclusiva propiedad del Vendedor y su comunicación o uso en el marco de las presentes Condiciones no implica, en relación con estos, ningún derecho o pretensión por parte del Comprador. Este último se obliga a no acometer ningún acto incompatible con la titularidad de los Derechos de Propiedad Intelectual.
- 13.2. El Comprador aclara que: a) el Vendedor es el titular exclusivo de las Marcas; b) se abstendrá de utilizar y de registrar marcas similares y/o que puedan confundirse con las Marcas; c) utilizará las Marcas únicamente en cumplimiento de las instrucciones del Vendedor y solo para los fines de las presentes Condiciones.
14. TRIBUNAL COMPETENTE Y LEY APLICABLE
- 14.1. Para cualquier controversia derivada o asociada a las presentes Condiciones Generales de venta y/o a cada Contrato como, a mero título de ejemplo y no exhaustivo, controversias relativas a su existencia, validez, interpretación, eficacia, ejecución, será competente para decidir con carácter exclusivo el Tribunal de Vicenza, también cuando el Contrato presente elementos de internacionalidad.
- 14.2. En derogación de lo anterior, el Vendedor está facultado en cualquier caso para llevar el contencioso ante el juez competente en el domicilio social del Comprador.
- 14.3. Las presentes Condiciones Generales de venta y/o cada Contrato se someten íntegramente a la ley italiana y se interpretan de conformidad con esta, también cuando el Contrato presente elementos de internacionalidad, excluyéndose expresamente la Convención de Viena de 1980.
15. PRIVACIDAD
- 15.1. El Comprador declara haber recibido toda la información prevista por el art. 13 del Reglamento UE n.º 2016/679 (RGPD) y autoriza el tratamiento de los datos personales para las finalidades de las presentes condiciones generales de venta y haber sido informado de que, respecto a los datos comunicados, puede ejercer los derechos previstos por el D. Leg. n.º 196/2003 y del Reglamento UE n.º 2016/679 (RGPD). El Vendedor declara que el responsable del tratamiento de los datos recogidos es Fami S.r.l, con domicilio social en Rosà (VI), Via Stazione Rossano n.º 13, n.º a efectos de IVA y n.º de identificación fiscal 03498610249.
16. CUMPLIMIENTO DE LA LEY 231/2001
- 16.1. El Comprador deja constancia de que Fami s.r.l. ha adoptado y aplica un Modelo de Organización, Gestión y Control conforme al D. Leg. 231/01, con el relativo Código Ético y Sistema Disciplinario cuyos detalles pueden consultarse en la web empresarial www.famisp.com. El Comprador se adhiere a los principios del mencionado Modelo de organización, gestión y control, así como a sus anexos y se compromete a cumplir con su contenido, principios y procedimientos y, en general, a abstenerse de cualquier comportamiento que pueda configurar las hipótesis de delito indicadas en el D. Leg. italiano 231/01 y siguientes modificaciones y complementos e indicadas en el Modelo de organización, gestión y control antes mencionado. Además, el Comprador se compromete a respetar y a exigir el respeto a sus empleados, de todos los principios contenidos en la citada documentación y los Protocolos de comportamiento previstos por nuestra organización, de acuerdo con el D. Leg. 231/2001 y anexos al presente contrato. La violación de las reglas previstas en los documentos mencionados supondrá un incumplimiento contractual grave.
17. DISPOSICIONES FINALES
- 17.1. Si una de las Partes omite entablar una acción legal o ejercer un derecho de acuerdo con estas Condiciones, dicho comportamiento de aceptación no podrá interpretarse como una renuncia definitiva a ejercer en el futuro la misma acción judicial o el mismo derecho.
- 17.2. La venta de los Productos por parte de Fami al Comprador no otorga a este último un derecho de exclusividad territorial ni permite al Comprador asumir la condición de distribuidor o concesionario de Fami.
- 17.3. La invalidez total o parcial de cada una de las disposiciones de las presentes Condiciones no afecta a la validez de las restantes disposiciones.

PATENTES

Algunos componentes están protegidos por un modelo de diseño comunitario y/o una patente de invención industrial.

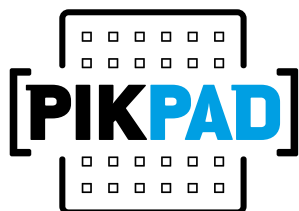

WWW.FAMISPA.COM

Disset Odiseo
900 17 17 00 - 93 586 15 60
comercial@dissetodiseo.com